





# THE WORLD NEEDS PLAY<sup>®</sup>

AT PLAYWORLD, WE BELIEVE PLAY SHOULD  
INSPIRE NEW IDEAS, CREATE OPPORTUNITIES  
FOR ALL, AND BUILD A FOUNDATION FOR  
COMMUNITIES OF THE FUTURE.



**INNOVATIVE.  
DARING.  
DISTINCT.  
PLAYWORLD.**







## PLAYWORLD TEAM

Our manufacturing team is full of masters at their craft who channel their passion for play and commitment to quality into creating products that last for generations.





## PLAYWORLD PRIDE

We're proud to have built our heritage upon providing products that communities like yours know you can rely on for safe adventures. We maintain our dedication to play value is only as strong as the integrity of our products.



## PLAYWORLD PROCESS

From the first cut of metal to the final coat of paint, each Playworld product passes through the hands of multiple team members. At every step, we ensure durability meets the demands of daring design through thorough inspection and rigorous testing.







## PLAYWORLD CRAFTSMANSHIP

Our team members ensure products are playground-ready by using premium materials and a methodical approach down to the final details.





## YOUR PLAYGROUND

With Playworld you're forging authentic connections and uniting your community through innovative designs and distinct craftsmanship.

Learn more at [Playworld.com/Craftsmanship](https://Playworld.com/Craftsmanship)



 **PLAYWORLD**  
The world needs play.



# TAKE A LOOK INSIDE

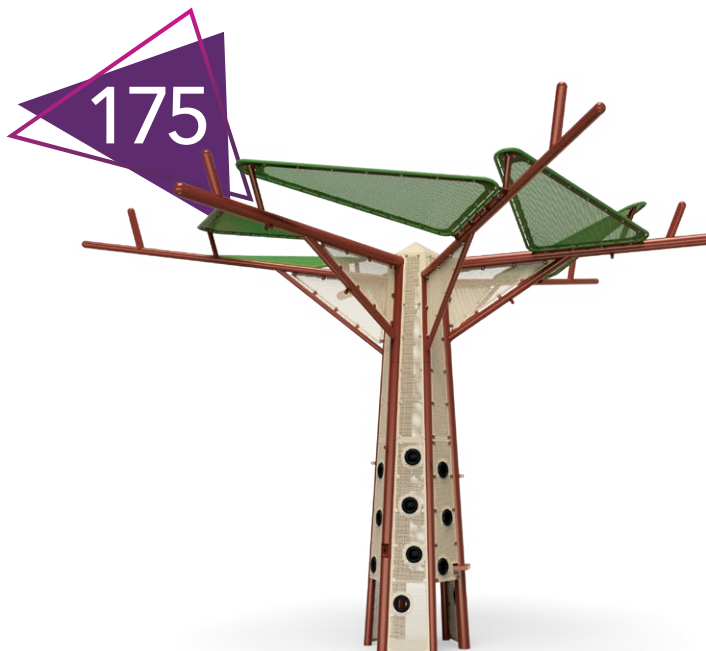
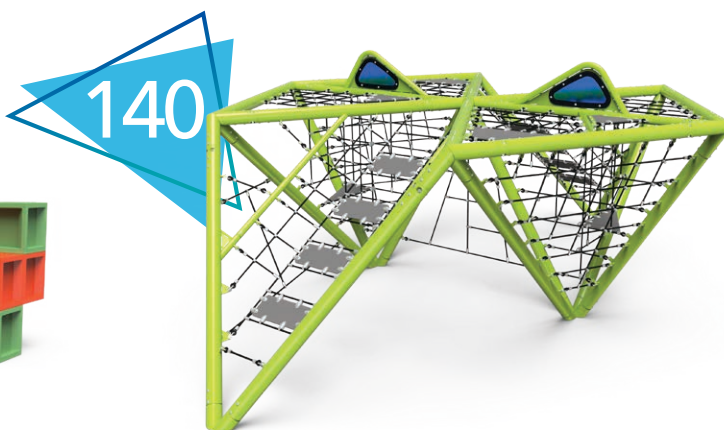

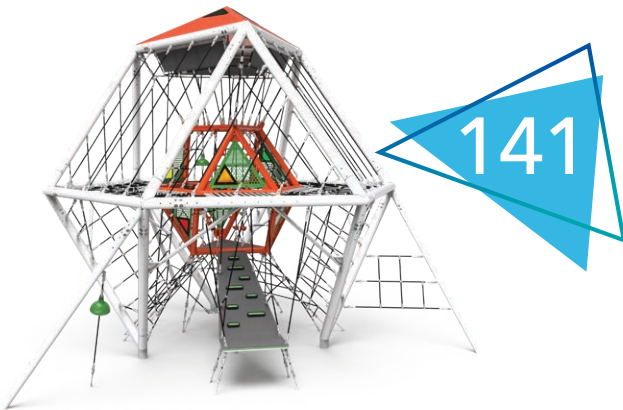
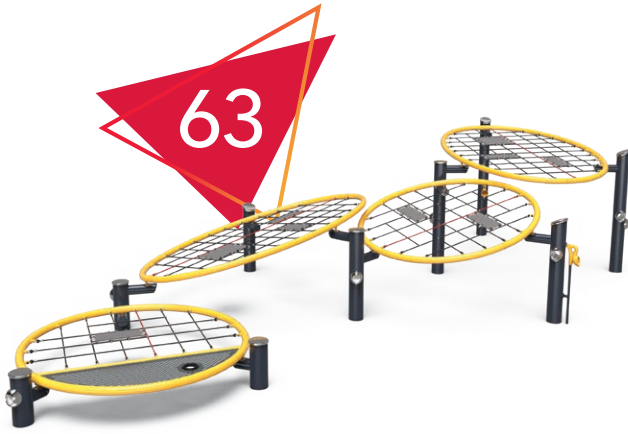

Craftmanship 2

Featured Products 12

Playground Gallery 22

Inclusion 38

School-Age 48

Early Childhood 90

Freestanding 116

Fitness & Wellness 156

Site Amenities 162

Components 166

Index 202

Colors 204



# QUITO™

Quito (pronounced KEE-toe) is a freestanding net climber that takes kids on a journey to the center of the web. Inspired by Quito, Ecuador, the capital city closest to the equator and the world's second highest capital city, Quito stands a towering 15.54' (4,74m) high. Its daring, distinctive design offers a commanding, compelling playground presence. Children will feel like geometric spelunkers as they climb, balance, and teeter their way in, over, and through the colorful center. With multiple points of entry, Quito includes an easy passage to the center, as well as a cozy space underneath.

Learn more at [Playworld.com/Quito](https://www.playworld.com/quito)



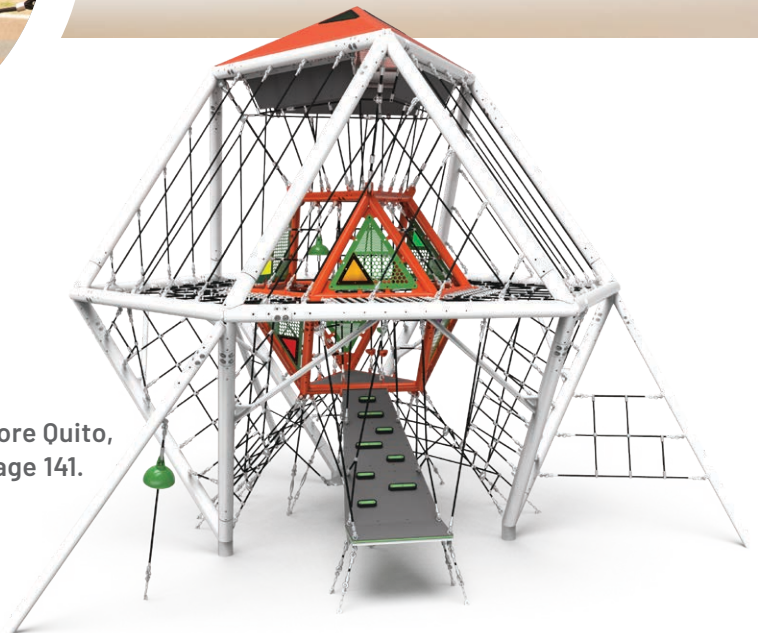

For more Quito,  
see page 141.

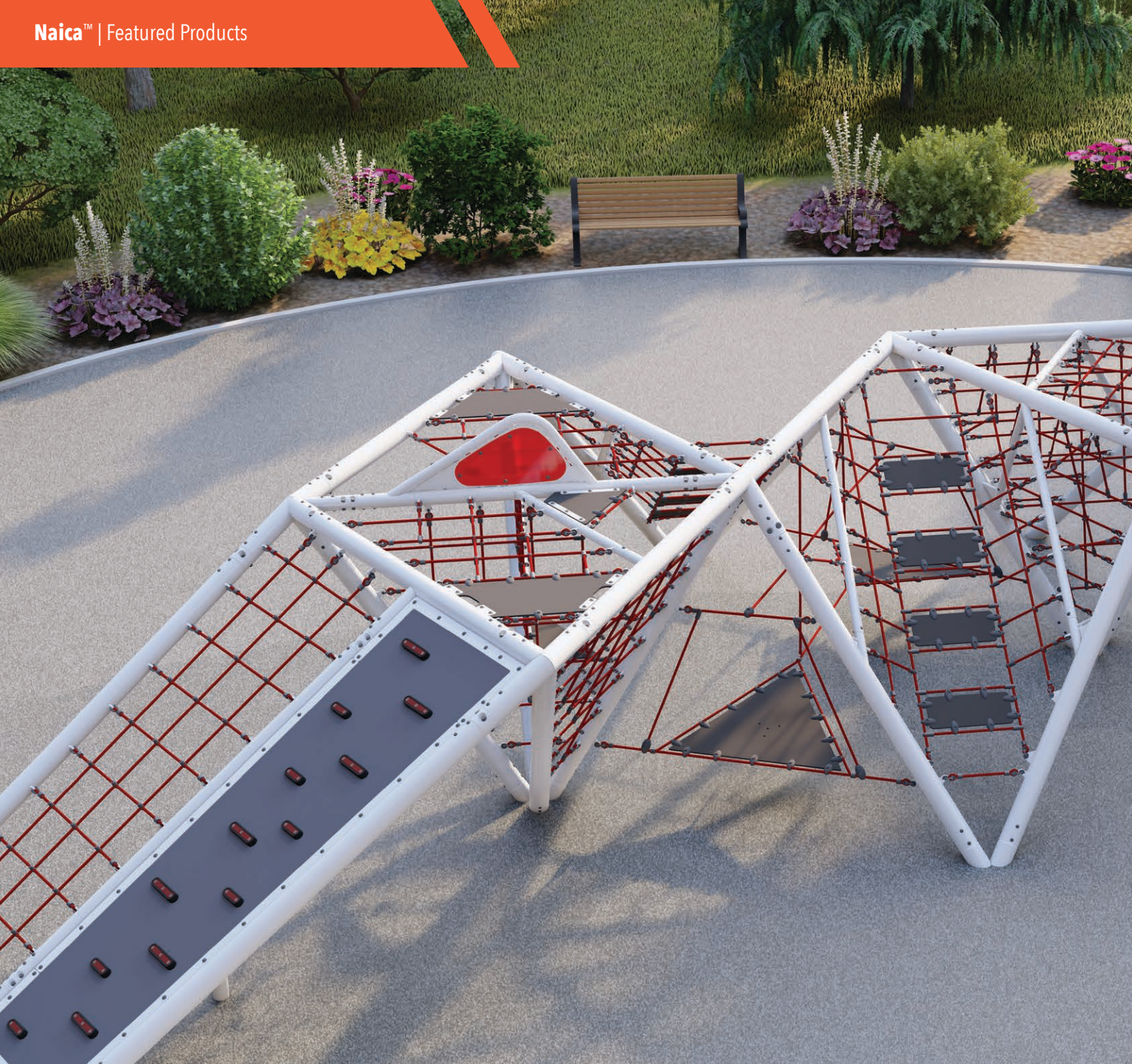

# NAICA™

Inspired by Mexico's Cave of the Crystals, Naica (pronounced Nī'-Ka) combines triangular climbing nets with traditional components to encourage skill development through daring exploration. Its distinctive design, which draws from the subterranean adventure of its namesake, is sure to make Naica the crowning jewel of any playground.

Learn more at [Playworld.com/Naica](https://Playworld.com/Naica)



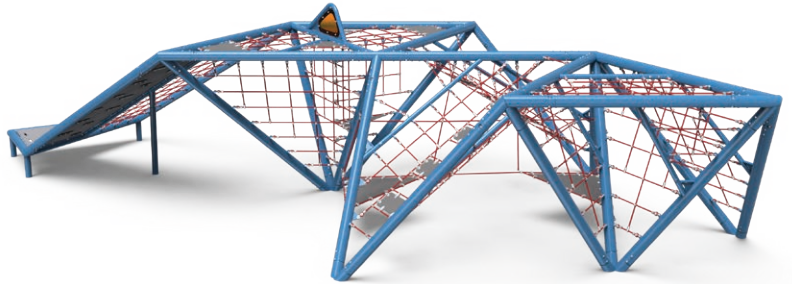

For more Naica, see page 140.  
*Mighty Descent slide sold separately.*

# ADVENTURE TUBES

Originally introduced in 2007, Adventure Tubes have been reinvented with a daring new design to take kids beyond a typical cylindrical tube experience into a more modern, complex space that's ripe for exploration. Made of sturdy rotomolded plastic with perforated steel windows for high visibility, Adventure Tubes will withstand the escapades of countless adventurers.

For more Adventure Tubes, see page 135.

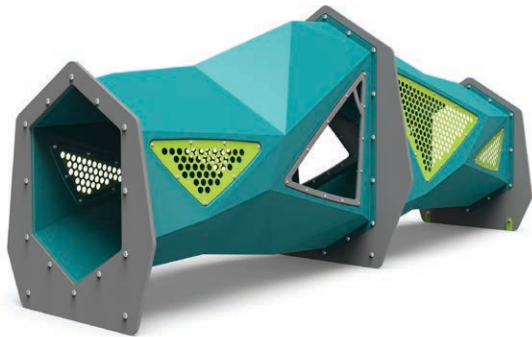





Patented: US11221116, CA3136514; other Patents pending

# PlaySoleil



## PLAYSOLEIL™

PlaySoleil is a patented, solar-powered light designed to fit easily into the posts of new or existing playground structures. Shining light in a downward trajectory from atop the equipment, PlaySoleil illuminates playgrounds, discouraging unwanted after-hours activity without the need to run electricity.

Learn more at [Playworld.com/PlaySoleil](http://Playworld.com/PlaySoleil)

*For more PlaySoleil see page 200.*



## DARE TO BE DIFFERENT

Let Playworld's custom graphics set your project apart with exclusive inlaid designs that inspire years of adventure. Whether you're setting the scene for a high seas excursion or looking to incorporate your own visuals, we have the tools and expertise necessary to perfect the playground of your dreams.

Find the perfect fit for your project with double-sided panel options, a full selection of sheet plastic colors, and printed fiberglass inserts. Including custom signs can also enhance the fun, uniting the playground, and your community, through a common theme.



Original Concept



**CONTACT YOUR LOCAL REP FOR MORE  
INFO ON CUSTOM PLAYGROUNDS!**

[PLAYWORLD.COM/CONTACT](http://PLAYWORLD.COM/CONTACT)







# RISE ABOVE PLAYGROUND

Worcester, Massachusetts  
Playworld Representative: *UltiPlay Parks & Playgrounds, Inc.*





**COZY COCOON™**

*PAGE 125*



**FRACTAL NET**

*PAGE 59*



**KALEIDOClimber**

*PAGE 182*





# FAIRMOUNT PARK

Golden, Colorado

Playworld Representative: Star Playgrounds



WELCOME

PLEASE SUPERVISE CHILDREN AT ALL TIMES

FOR YOUR PROTECTION AND THE PROTECTION OF OTHERS, PLEASE FOLLOW THESE RULES:

- 1. No running on the playground.
- 2. No pushing or shoving.
- 3. No climbing on equipment.
- 4. No swinging on equipment.
- 5. No playing on equipment when it is raining or wet.
- 6. No playing on equipment when it is too hot or too cold.
- 7. No playing on equipment when it is too dark.
- 8. No playing on equipment when it is too windy.
- 9. No playing on equipment when it is too noisy.
- 10. No playing on equipment when it is too crowded.





**UNITY® BASKET SWING**

PAGE 132



**MIGHTY DESCENT**

PAGE 172



**BALANCE BEAM**

PAGE 136





# WINDOM PUBLIC SCHOOL

Windom, Minnesota

*Playworld Representative: Midwest Playscapes, Inc.*









**BOUNCE BUTTON**

PAGE 136



**UNITY® HOOPLA SWING**

PAGE 132



**UNITY® SPINR**

PAGE 122





# HUFNAGLE PARK

Lewisburg, Pennsylvania  
*Playworld*



Thank You  
for visiting Kidsburg

Playworld  
Manufactured in Germany by Playworld

Playworld is a leader in providing safe and fun play equipment for all ages. Our equipment is designed to provide a safe and fun play experience for all ages. Our equipment is designed to provide a safe and fun play experience for all ages. Our equipment is designed to provide a safe and fun play experience for all ages.





**MIGHTY DESCENT**  
WITH PRISM PASS  
PAGE 172



**COZY COCOON™**  
PAGE 125



**ADVENTURE TUBES**  
PAGE 135



**QUITO™**  
PAGE 141









## Inclusion

At Playworld, we go beyond American with Disabilities Act (ADA) standards to design inclusive play spaces for children with different mobility, emotional, neurological, and intellectual needs. From wide, wheelchair-accessible pathways to sensory-rich activities that involve everyone in fun and learning, Playworld offers inclusive play spaces customized to your community's needs. It's time to build a space where everyone can connect, play, and grow together.

40 **8 Keys to Inclusion**

42 **Inclusive Structures**

8

### 1. THE 'COOLEST THING'

Identify the piece of equipment that children will be the most excited about, and ensure it's usable for all.

### 2. SOCIAL PLAY

Provide play events that stimulate the imagination. Carefully select and place equipment to provide opportunities for solitary, parallel, associative, and cooperative play.

### 3. SENSORY PLAY

Incorporate activities that engage the auditory, tactile, proprioceptive, visual, and vestibular sensory systems.

### 4. LEVELS OF CHALLENGE

Choose physical play activities that provide graduated levels of challenge, ensuring all ages and abilities are actively engaged on the playground.

### 5. ZONES

Invite engagement between children of diverse abilities by locating similar types of equipment in the same area. Set the zones so that they're easily found via an orientation path, which guides people to different areas of play.

### 6. ROUTES AND MANEUVERABILITY

Routes through the play area should be wide enough for people in wheelchairs to pass one another, and to enter, turn, and exit without difficulty.

### 7. UNITARY SURFACING

Protective surfacing forms a unitary shock absorbing surface, which makes it easier for wheelchairs and strollers to enter and navigate the play space.

### 8. FENCING

Important to keep children safe so they don't run or wander out of the play space. A contained play area is especially helpful for those on the autism spectrum.

1

## 8 KEYS TO INCLUSION

By using these 8 Keys in your playground design, you're creating a community asset that invites all people to play, learn, and have fun.

5





2



6

4



3

7

START

# INCLUSION'S INFLUENCE

Inclusive designs not only make an impact on the playground, but on the next generation of your community. By creating zones, offering a variety of challenges, and ensuring maneuverability, you're fostering a fun, welcoming environment for all to enjoy in the years to come.

[Playworld.com/Inclusion](http://Playworld.com/Inclusion)

## Fencing

Fencing creates safe boundaries and encourages exploration and independent play.



- Climbing Zone
- Swinging Zone
- Spinning Zone
- Rocking Zone

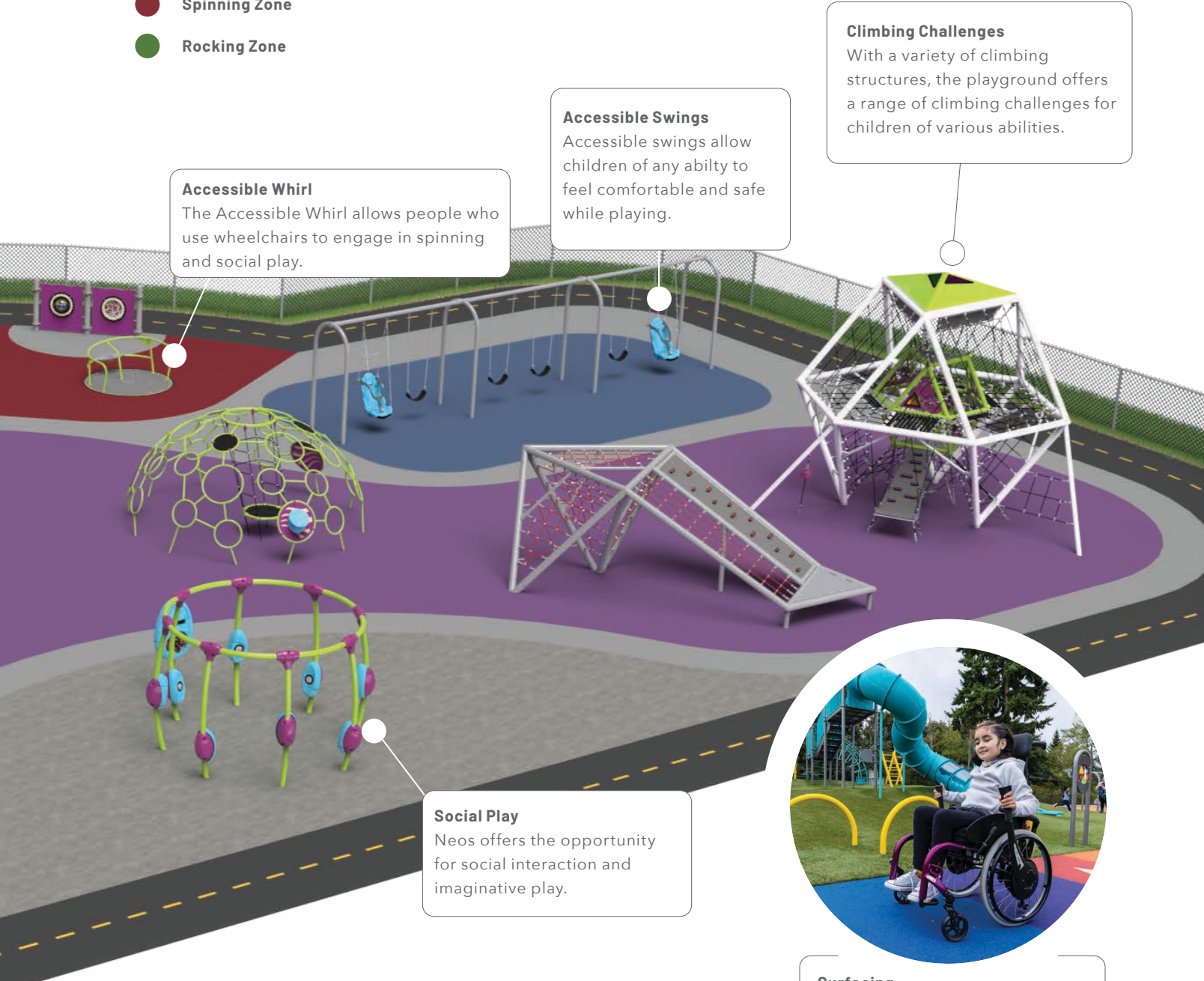

**Accessible Whirl**  
The Accessible Whirl allows people who use wheelchairs to engage in spinning and social play.

**Accessible Swings**  
Accessible swings allow children of any ability to feel comfortable and safe while playing.

**Climbing Challenges**  
With a variety of climbing structures, the playground offers a range of climbing challenges for children of various abilities.

**Social Play**  
Neos offers the opportunity for social interaction and imaginative play.



**Surfacing**  
Unitary surfacing makes it easy for everyone to maneuver the playground and engage in play.

## Inclusive Go-Getter Garden

IDEA-2302 • AGES: 2-12

**TOP INCLUSIVE PRODUCT**

Look for this icon to spot our top inclusive products!

PRODUCT	ITEM	SPACE REQUIRED	SIZE	FALL HEIGHT	EVENTS	ADA	ASTM F1487	CPSC PUB.325	CAN/CSA Z614	EN1176	APPROX. PRICE
Inclusive Go-Getter Garden	IDEA-2302	145' 0" x 85' 0" (44,2m x 25,91m)	25' 8" x 21' 9" x 10' 10" (7,82m x 6,63m x 3,3m)	9' 4" (2,83m)	64	•	•	•	•	•	\$326,500



**Inclusive Suburbia**

IDEA-2300 • AGES: 2-12

**TAKE A CLOSER LOOK AT THESE INCLUSIVE PRODUCTS!**

**NEOS® 360 ACCESSIBLE**



PAGE 118

**PLAYTOWN™ COMMUNITY HELPER**



PAGE 92

**UNITY® BASKET SWING**



PAGE 132

PRODUCT	ITEM	SPACE REQUIRED	SIZE	FALL HEIGHT	EVENTS	USERS	INSTALL HOURS	WEIGHT	ADA	ASTM F1487	CPSC PUB.325	CAN/CSA Z614	EN1176	APPROX. PRICE
Inclusive Suburbia	IDEA-2300	90' 0" x 80' 0" (27,43m x 24,38m)	18' 11" x 32' 1" x 12' 10" (5,77m x 9,78m x 3,91m)	6' 8" (2,03m)	77	166	96.58	7878 lbs (3573 kg)	•	•	•	•		\$177,500



## Inclusive Peacock Plaza

IDEA-2301 • AGES: 5-12



### AEROGLIDER™



PAGE 168

### UNITY® SPINR



PAGE 122

### SLITHER SLIDE WITH SLIDE-A-SIDE



PAGE 171

PRODUCT	ITEM	SPACE REQUIRED	SIZE	FALL HEIGHT	EVENTS	USERS	INSTALL HOURS	WEIGHT	ADA	ASTM F1487	CPSC PUB.325	CAN./CSA Z614	EN1176	APPROX. PRICE
Inclusive Peacock Plaza	IDEA-2301	109' 6" x 75' 0" (33,38m x 22,86m)	64' 3" x 43' 0" x 14' 3" (19,58m x 13,11m x 4,34m)	8' 5" (2,57m)	55	212	202.83	15863 lbs (7194 kg)	•	•	•	+		\$261,000

## CUSTOMIZE YOUR DESIGN

Start your inclusive playground with the design shown. Then, add more inclusive products either to the existing layout or to your overall space so you can best fit your community's needs!

[Playworld.com/Inclusion](http://Playworld.com/Inclusion)



Playmakers® Community Corner

500-2306 • AGES: 5-12

TAKE A CLOSER LOOK AT POSSIBLE ADDITIONS TO MAKE YOUR DESIGN MORE INCLUSIVE.

### BALANCE TRAX



PAGE 136

### COZY COCOON™



PAGE 125

### CONE SPINNER DOUBLE-DECKER

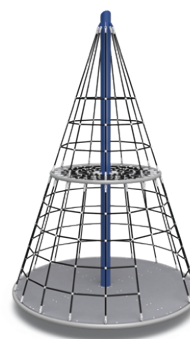

PAGE 123

PRODUCT	ITEM	SPACE REQUIRED	SIZE	FALL HEIGHT	EVENTS	USERS	INSTALL HOURS	WEIGHT	ADA	ASTM F1487	EPSC PUB.325	CMV/CSA Z614	EN1176	APPROX. PRICE
Playmakers® Community Corner	500-2306	36' 0" x 36' 0" (10,97m x 10,97m)	22' 9" x 28' 10" x 8' 4" (6,93m x 8,79m x 2,54m)	8' 5" (2,57m)	77	166	96.33	7877 lbs (3573 kg)	•	•	•	•		\$57,000
Playmakers® Imagination Station	500-2206	69' 0" x 58' 0" (21,03m x 17,68m)	56' 11" x 45' 2" x 16' 0" (17,35m x 13,77m x 4,88m)	5' 0" (1,52m)	30	183	177.83	11529 lbs (5229 kg)	•	•	•	+		\$176,500





## CUSTOM ADDITIONS

Incorporating custom panels, like the Playground Communication Board, can be a great way to improve the inclusivity of your play space!



Playmakers® Imagination Station

500-2206 • AGES: 5-12

**CONTACT YOUR LOCAL REP FOR MORE  
INFO ON INCLUSIVE PLAYGROUNDS!**

[PLAYWORLD.COM/CONTACT](http://PLAYWORLD.COM/CONTACT)





## School-Age

As kids get older, it takes a little more to excite them, keep them engaged, and push them out of their comfort zones. These playgrounds go above and beyond to address their needs.

- 50 Sky Towers<sup>®</sup>
- 54 PlayCubes<sup>®</sup>
- 60 PlayForm 7<sup>®</sup>
- 62 infiNET™
- 66 Unity<sup>®</sup> Connect
- 70 Branch Out<sup>®</sup>
- 74 Themed
- 78 Rope Play
- 80 Classic
- 89 PlaySimple<sup>®</sup>

Sky Towers® Hannah's Hideaway

500-2038 • AGES: 5-12 • SPACE REQUIRED: 30' 4" X 39' 6"

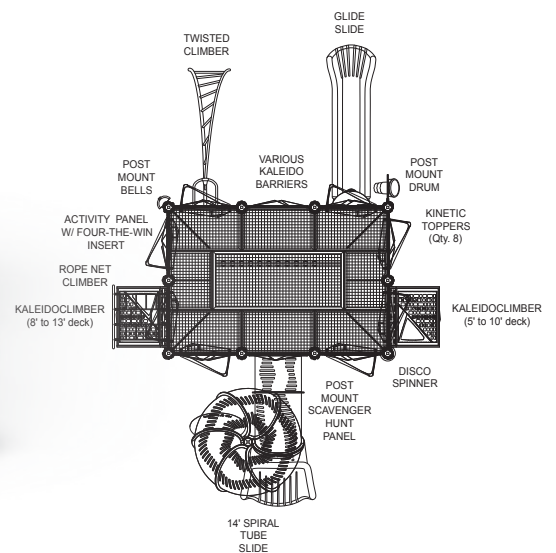

PRODUCT	ITEM	SPACE REQUIRED	SIZE	FALL HEIGHT	EVENTS	USERS	INSTALL HOURS	WEIGHT	ADA	ASTM F1487	CPSC PUB. 325	CAN/CSA Z614	EN1176	APPROX. PRICE
Sky Towers® Hannah's Hideaway	500-2038	30' 4" x 39' 6" (9,24m x 12,04m)	18' 0" x 25' 3" x 26' 1" (5,49m x 7,7m x 7,95m)	8' 6" (2,59m)	20	53	129	11554 lbs (5240 kg)	•	•	•	+		\$220,500

+CSA and EN compliant versions available.

All play equipment must be installed over an appropriate impact absorbing surface that complies with ASTM or CSA standards. See your Playworld representative for more information.



### Sky Towers® Emerson Heights

500-2037 • AGES: 5-12 • SPACE REQUIRED: 41' 2" X 43' 2"

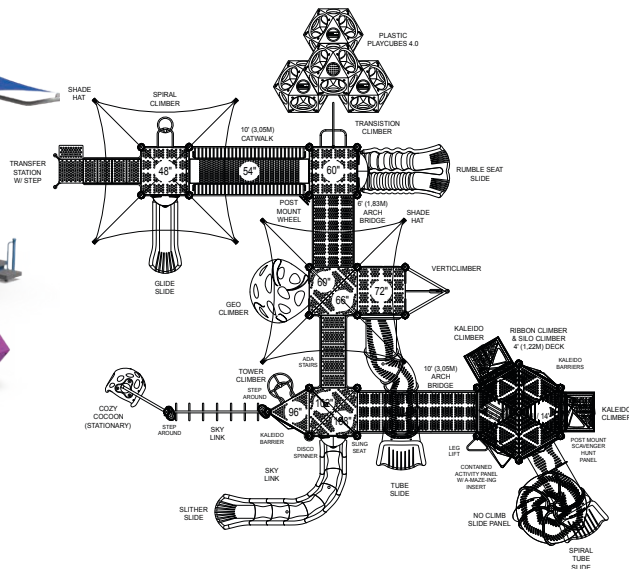
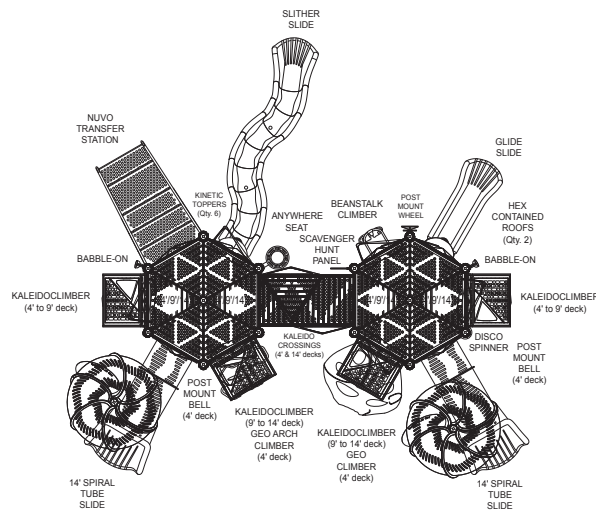

### Sky Towers® Toula's Tower

500-2115 • AGES: 5-12 • SPACE REQUIRED: 58' 6" X 58' 6"

PRODUCT	ITEM	SPACE REQUIRED	SIZE	FALL HEIGHT	EVENTS	USERS	INSTALL HOURS	WEIGHT	ADA	ASTM F1487	CPSC PUB. 325	CAN/CSA Z614	EN1176	APPROX. PRICE
Sky Towers® Emerson Heights	500-2037	41' 2" x 43' 2" (12,55m x 13,16m)	28' 11" x 27' 4" x 26' 7" (8,81m x 8,33m x 8,1m)	9' 0" (2,74m)	21	101	126	11311 lbs (5130 kg)	•	•	•	•	•	\$218,000
Sky Towers® Toula's Tower	500-2115	58' 6" x 58' 6" (17,83m x 17,83m)	46' 3" x 44' 8" x 25' 9" (14,1m x 13,62m x 7,85m)	9' 0" (2,74m)	32	127	149	11948 lbs (5419 kg)	•	•	•	•	•	\$198,000

All playgrounds shown are in-ground mount and available as surface mount. Additional ground level components may be required for ADA and ASTM compliance.



### Sky Towers® Jude's Tower

500-2039 • AGES: 5-12 • SPACE REQUIRED: 49' 10" X 41' 0"



PRODUCT	ITEM	SPACE REQUIRED	SIZE	FALL HEIGHT	EVENTS	USERS	INSTALL HOURS	WEIGHT	ADA	ASTM F1487	CPSC PUB. 325	CAN/CSA Z614	EN1176	APPROX. PRICE
Sky Towers® Jude's Tower	500-2039	49' 10" x 41' 0" (15,19m x 12,5m)	37' 4" x 26' 8" x 26' 1" (11,38m x 8,13m x 7,95m)	8' 6" (2,59m)	28	75	150	13621 lbs (6177 kg)	•	•	•	+		\$253,000

+CSA and EN compliant versions available.

All play equipment must be installed over an appropriate impact absorbing surface that complies with ASTM or CSA standards. See your Playworld representative for more information.



### Sky Towers® Crimson Sky

500-2036 • AGES: 5-12 • SPACE REQUIRED: 49' 0" X 29' 6"

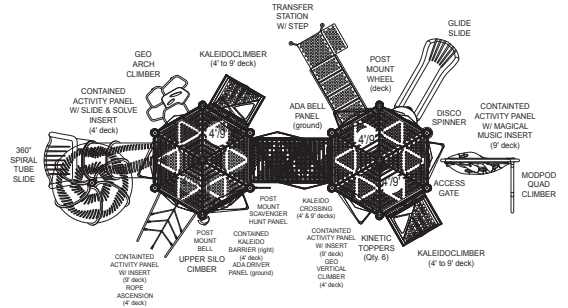

### Playmakers® Monkeying Around

500-2033 • AGES: 5-12 • SPACE REQUIRED: 47' 3" X 33' 2"

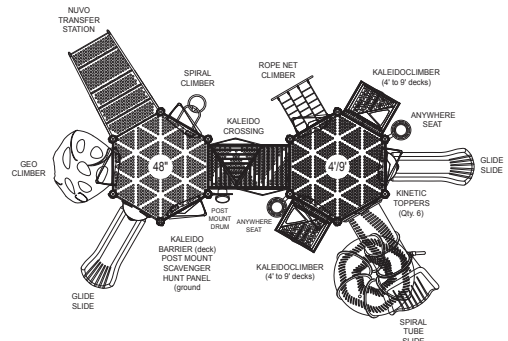
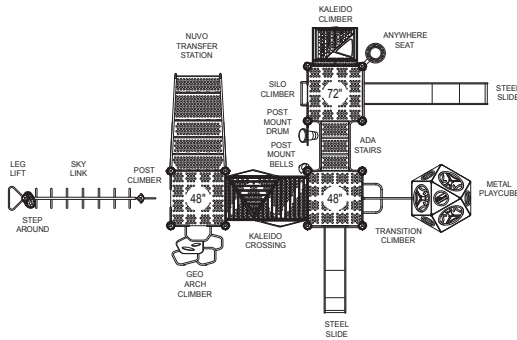

### Playmakers® Lydia's Rainbow

500-2035 • AGES: 5-12 • SPACE REQUIRED: 43' 6" X 34' 6"

PRODUCT	ITEM	SPACE REQUIRED	SIZE	FALL HEIGHT	EVENTS	USERS	INSTALL HOURS	WEIGHT	ADA	ASTM F1487	EPSC PUB.325	CHY/CSA Z614	EN1176	APPROX. PRICE
Sky Towers® Crimson Sky	500-2036	49' 0" x 29' 6" (14,94m x 8,99m)	34' 9" x 17' 1" x 20' 7" (10,59m x 5,21m x 6,27m)	9' 0" (2,74m)	22	82	108	8220 lbs (3728 kg)	•	•	•	+		\$157,500
Playmakers® Monkeying Around	500-2033	47' 3" x 33' 2" (14,4m x 10,11m)	35' 0" x 20' 11" x 11' 2" (10,67m x 6,38m x 3,4m)	8' 0" (2,44m)	16	43	47	3845 lbs (1744 kg)	•	•	•	•	•	\$72,500
Playmakers® Lydia's Rainbow	500-2035	43' 6" x 34' 6" (13,26m x 10,52m)	30' 9" x 21' 0" x 19' 7" (9,37m x 6,4m x 5,97m)	9' 0" (2,74m)	13	52	67	5358 lbs (2430 kg)	•	•	•	+		\$94,000

All playgrounds shown are in-ground mount and available as surface mount. Additional ground level components may be required for ADA and ASTM compliance.





These geometric, sculptural structures are instant conversation starters. PlayCubes® are available in both metal and traditional plastic to meet the demands of urban or residential play spaces!



### PlayCubes® 1.0M

PLAYCUBES-1M • AGES: 2-12  
Space required: 16' 4" x 17' 0"



### PlayCubes® 4.0

PLAYCUBES-4 • AGES: 5-12 • SPACE REQUIRED: 22' 0" X 20' 8"

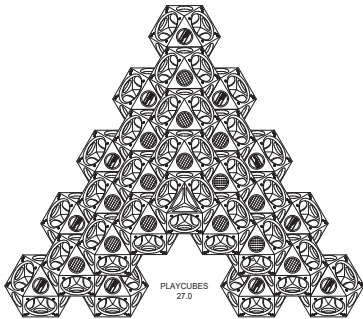

### PlayCubes® 27.0

PLAYCUBES-27 • AGES: 5-12 • SPACE REQUIRED: 37' 0" X 33' 8"



PRODUCT	ITEM	SPACE REQUIRED	SIZE	FALL HEIGHT	EVENTS	USERS	INSTALL HOURS	WEIGHT	ADA	ASTM F1487	EPSC PUB.325	GMV/CSA Z614	EN176	APPROX. PRICE
PlayCubes® 1.0M (Metal)	PLAYCUBES-1M	16' 4" x 17' 0" (4,98m x 5,18m)	4' 4" x 4' 11" x 4' 2" (1,32m x 1,5m x 1,27m)	4' 2" (1,27m)	1	4	3	335 lbs (152 kg)	•	•	•	•	•	\$7,239
PlayCubes® 1.0	PLAYCUBES-1	16' 4" x 16' 11" (4,98m x 5,16m)	4' 4" x 4' 11" x 4' 1" (1,32m x 1,5m x 1,24m)	4' 1" (1,24m)	1	4	2	153 lbs (70 kg)	•	•	•	•	•	\$3,725
PlayCubes® 4.0M (Metal)	PLAYCUBES-4M	22' 0" x 20' 8" (6,71m x 6,3m)	9' 11" x 8' 8" x 6' 2" (3,02m x 2,64m x 1,88m)	6' 2" (1,88m)	4	15	10	1242 lbs (563 kg)	•	•	•	•	•	\$27,326
PlayCubes® 4.0	PLAYCUBES-4	22' 0" x 20' 8" (6,71m x 6,3m)	9' 11" x 8' 8" x 6' 2" (3,02m x 2,64m x 1,88m)	6' 2" (1,88m)	4	15	6	556 lbs (252 kg)	•	•	•	•	+	\$14,434
PlayCubes® 27.0	PLAYCUBES-27	37' 0" x 33' 8" (11,28m x 10,26m)	24' 11" x 21' 7" x 12' 10" (7,6m x 6,58m x 3,91m)	10' 5" (3,18m)	27	92	41	3308 lbs (1501 kg)	•	•	•	•	•	\$93,856

All playgrounds shown are in-ground mount and available as surface mount. Additional ground level components may be required for ADA and ASTM compliance.



### PlayCubes® 13.OSL

PLAYCUBES-13SL • AGES: 5-12 • SPACE REQUIRED: 37' 4" X 42' 6"

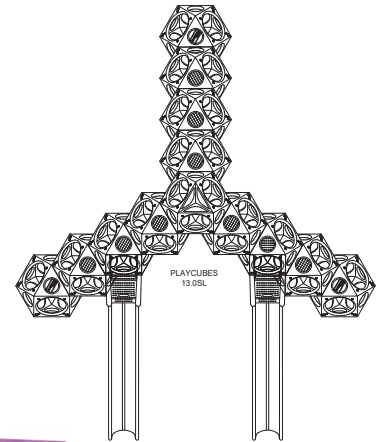

PRODUCT	ITEM	SPACE REQUIRED	SIZE	FALL HEIGHT	EVENTS	USERS	INSTALL HOURS	WEIGHT	ADA	ASTM F1487	CPSC PUB. 325	CAN / CSA Z614	EN1176	APPROX. PRICE
PlayCubes® 13.OSL	PLAYCUBES-13SL	37' 4" x 42' 6" (11,38m x 12,95m)	24' 11" x 30' 2" x 12' 10" (7,6m x 9,2m x 3,91m)	10' 5" (3,16m)	15	55	26	2069 lbs (939 kg)	•	•	•	•		\$58,363

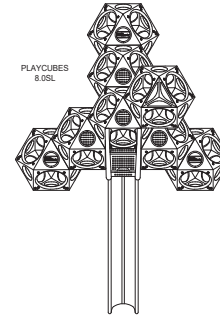

### PlayCubes® 8.SL

PLAYCUBES-8SL • AGES: 5-12

SPACE REQUIRED: 27' 0" X 33' 6"

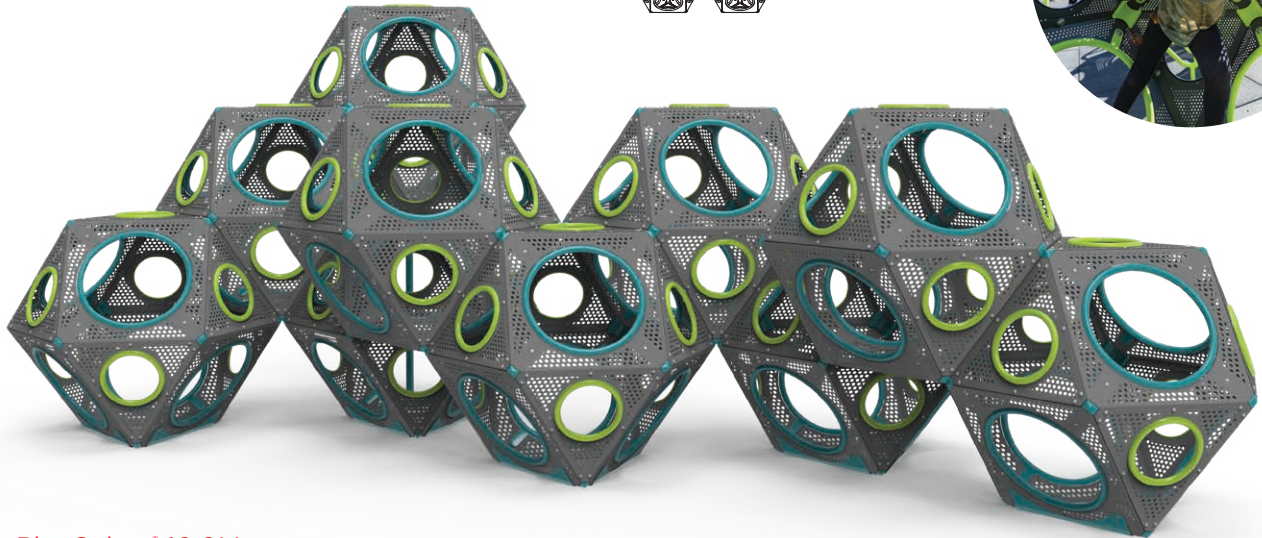
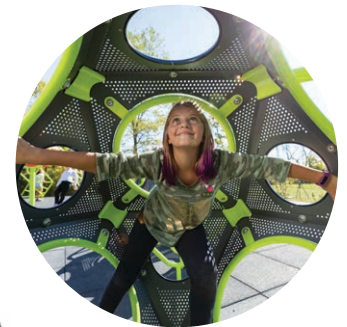
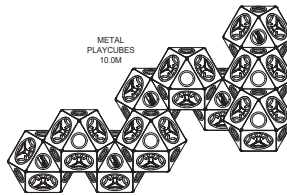

### PlayCubes® 10.0M

PLAYCUBES-10M • AGES: 5-12 • SPACE REQUIRED: 32' 0" X 25' 0"

PRODUCT	ITEM	SPACE REQUIRED	SIZE	FALL HEIGHT	EVENTS	USERS	INSTALL HOURS	WEIGHT	ADA	ASTM F1487	CPSC PUB.325	CAN/CSA Z614	EN1176	APPROX. PRICE
PlayCubes® 8.SL	PLAYCUBES-8SL	27' 0" x 33' 6" (8,23m x 10,21m)	14' 11" x 21' 6" x 10' 10" (4,55m x 6,55m x 3,3m)	8' 5" (2,57m)	9	33	15	1260 lbs (572 kg)	•	•	•	•	+	\$34,901
PlayCubes® 8.SL (Metal)	PLAYCUBES-8SLM	27' 2" x 34' 0" (8,28m x 10,36m)	14' 11" x 21' 10" x 10' 9" (4,55m x 6,65m x 3,28m)	8' 6" (2,59m)	9	33	23	2702 lbs (1226 kg)	•	•	•	•	•	\$66,235
PlayCubes® 10.0M (Metal)	PLAYCUBES-10M	32' 0" x 25' 0" (9,75m x 7,62m)	19' 11" x 12' 11" x 8' 3" (6,07m x 3,94m x 2,51m)	8' 3" (2,51m)	10	36	25	2962 lbs (1343 kg)	•	•	•	•	•	\$66,665
PlayCubes® 10.0	PLAYCUBES-10	31' 11" x 25' 0" (9,73m x 7,62m)	19' 11" x 12' 11" x 8' 2" (6,07m x 3,94m x 2,49m)	8' 2" (2,49m)	10	36	15	1269 lbs (576 kg)	•	•	•	•	+	\$35,075

All playgrounds shown are in-ground mount and available as surface mount. Additional ground level components may be required for ADA and ASTM compliance.

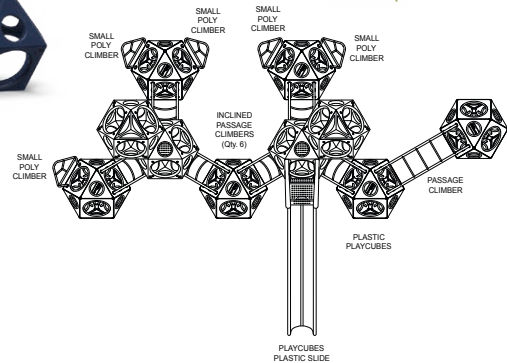

**PlayCubes® 10.0CSL**

PLAYCUBES-10CSL • AGES: 5-12 • SPACE REQUIRED: 45' 6" X 34' 0"

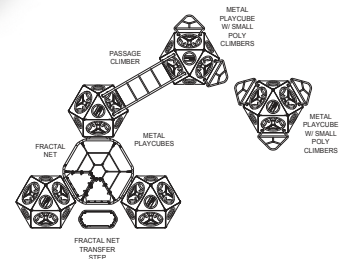
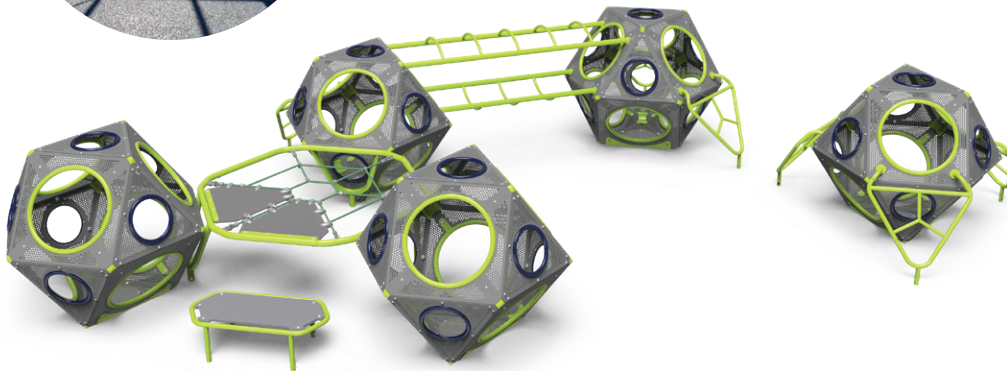
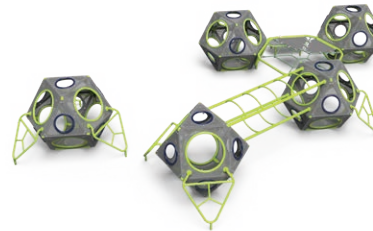

**PlayCubes® 5.0MCN**

PLAYCUBES-5MCN • AGES: 5-12 • SPACE REQUIRED: 36' 8" X 29' 10"

PRODUCT	ITEM	SPACE REQUIRED	SIZE	FALL HEIGHT	EVENTS	USERS	INSTALL HOURS	WEIGHT	ADA	ASTM F1487	CPSC PUB. 325	CAN/CSA Z614	EN1176	APPROX. PRICE
PlayCubes® 10.0CSL	PLAYCUBES-10CSL	45' 6" x 34' 0" (13,87m x 10,36m)	33' 3" x 21' 9" x 10' 10" (10,13m x 6,63m x 3,3m)	8' 5" (2,57m)	23	66	34	2042 lbs (927 kg)	•	•	•	•	+	\$51,175
PlayCubes® 5.0MCN	PLAYCUBES-5MCN	36' 8" x 29' 10" (11,18m x 9,09m)	24' 7" x 17' 8" x 4' 3" (7,49m x 5,39m x 1,3m)	4' 3" (1,3m)	12	32	24	1969 lbs (893 kg)	•	•	•	•	•	\$43,953

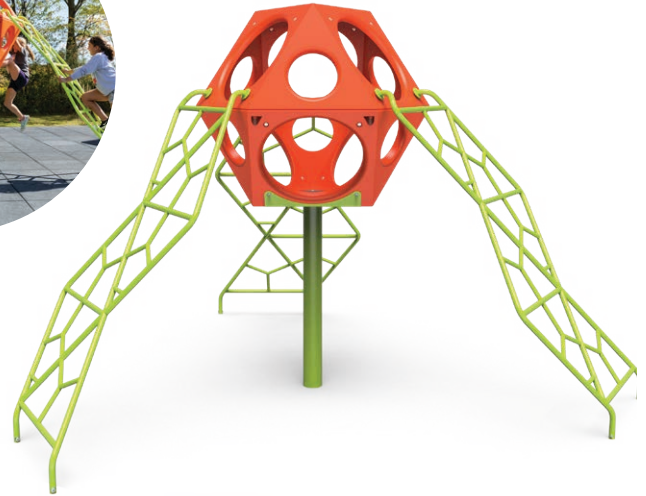
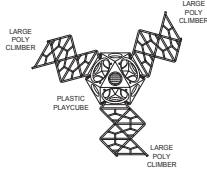

### PlayCubes® 1.1C

PLAYCUBES-1.1C • AGES: 5-12 • SPACE REQUIRED: 24' 8" X 24' 2"

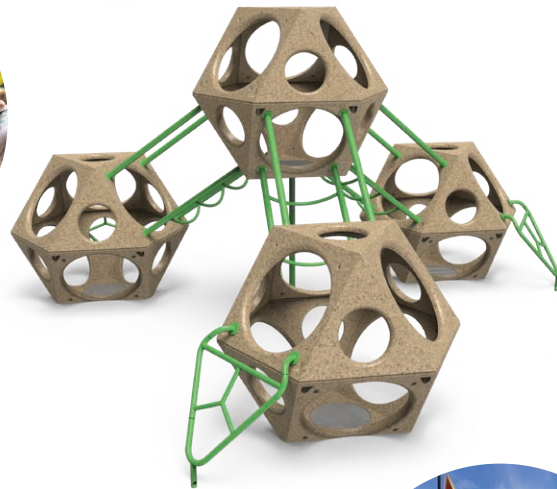
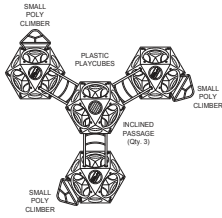

### PlayCubes® 4.0C

PLAYCUBES-4C • AGES: 5-12 • SPACE REQUIRED: 27' 10" X 26' 10"

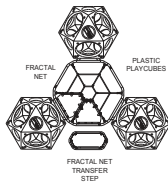

### PlayCubes® 3.0N

PLAYCUBES-3N • AGES: 2-12 • SPACE REQUIRED: 25' 10" X 24' 2"

PRODUCT	ITEM	SPACE REQUIRED	SIZE	FALL HEIGHT	EVENTS	USERS	INSTALL HOURS	WEIGHT	ADA	ASTM F1487	CPSC PUB.325	CAN/CSA Z614	EN1176	APPROX. PRICE
PlayCubes® 1.1C	PLAYCUBES-1.1C	24' 8" x 24' 2" (7,52m x 7,37m)	12' 6" x 12' 0" x 8' 2" (3,81m x 3,66m x 2,49m)	8' 2" (2,49m)	4	9	8	362 lbs (165 kg)	•	•	•	•	•	\$7,872
PlayCubes® 4.0C	PLAYCUBES-4C	27' 10" x 26' 10" (8,48m x 8,18m)	15' 8" x 14' 8" x 8' 2" (4,78m x 4,47m x 2,49m)	8' 2" (2,49m)	10	27	13	728 lbs (330 kg)	•	•	•	•	+	\$18,043
PlayCubes® 3.0N	PLAYCUBES-3N	25' 10" x 24' 2" (7,87m x 7,37m)	13' 8" x 11' 11" x 4' 1" (4,17m x 3,63m x 1,24m)	4' 1" (1,24m)	4	16	10	607 lbs (276 kg)	•	•	•	•	•	\$15,049

All playgrounds shown are in-ground mount and available as surface mount. Additional ground level components may be required for ADA and ASTM compliance.



### PlayForm 7® Laminated Bamboo

PLAYFORM7-B • AGES: 5-12 • SPACE REQUIRED: 37' 5" X 70' 5"

\*U.S. Patent D809619S



PRODUCT	ITEM	SPACE REQUIRED	SIZE	FALL HEIGHT	EVENTS	USERS	INSTALL HOURS	WEIGHT	ADA	ASTM F1487	CPSC PUB. 325	CAN/CSA Z614	EN1176	APPROX. PRICE
PlayForm 7® Laminated Bamboo	PLAYFORM7-B	37' 5" x 70' 5" (11,41m x 21,46m)	58' 5" x 25' 5" x 10' 2" (17,81m x 7,75m x 3,1m)	9' 2" (2,8m)	21	50	56	2624 lbs (1190 kg)	•	•	•	•	•	\$115,999



Shown with laminated bamboo; also available with translucent polycarbonate or sheet plastic panels.





infiNET is a hybrid "netform" solution that replaces traditional platforms and ramps with terraced rings and portals to increase challenge, play value, and perceived risk.

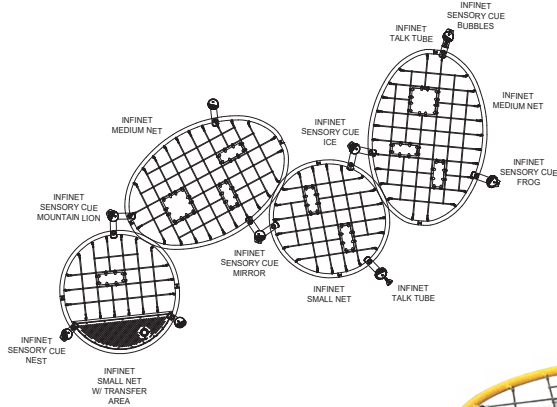

**infiNET™ INET-1810**

INET-1810 • AGES: 5-12 • SPACE REQUIRED: 42' 8" X 34' 8"

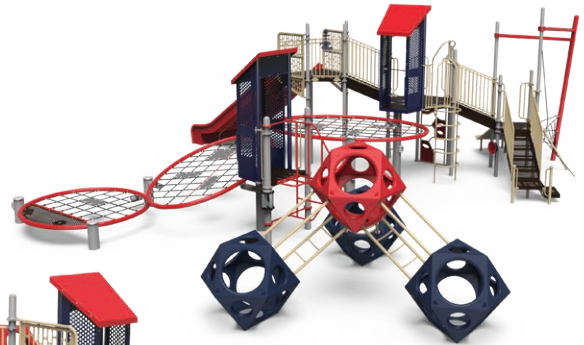
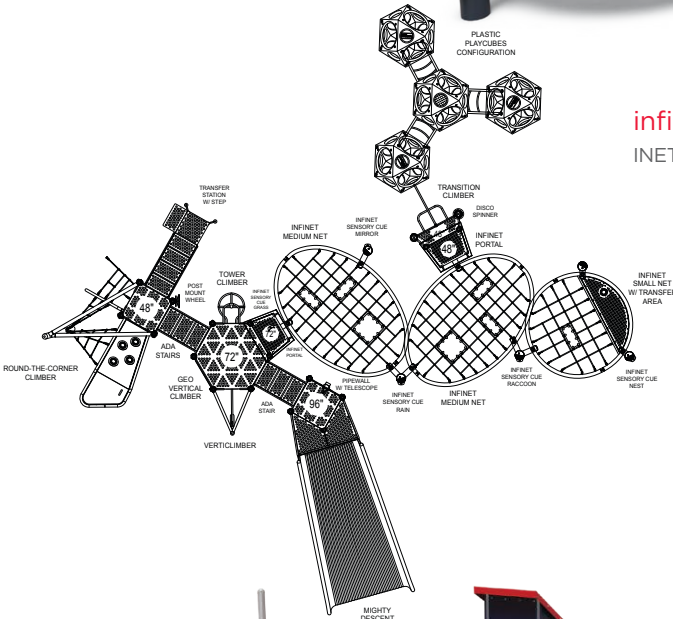

**infiNET™ INET-2205**

INET-2205 • AGES: 5-12 • SPACE REQUIRED: 59' 5" X 62' 6"

PRODUCT	ITEM	SPACE REQUIRED	SIZE	FALL HEIGHT	EVENTS	USERS	INSTALL HOURS	WEIGHT	ADA	ASTM F1487	CPSC PUB. 329	CAN./CSA Z614	EN1176	APPROX. PRICE
infiNET™ INET-1810	INET-1810	42' 8" x 34' 8" (13,01m x 10,57m)	30' 6" x 22' 6" x 7' 9" (9,3m x 6,86m x 2,36m)	7' 4" (2,23m)	11	50	36	2499 lbs (1134 kg)	•	•	•	•	•	\$53,500
infiNET™ INET-2205	INET-2205	59' 5" x 62' 6" (18,11m x 19,05m)	47' 2" x 48' 6" x 14' 0" (14,38m x 14,78m x 4,27m)	8' 0" (2,44m)	25	114	90	6838 lbs (3101 kg)	•	•	•	•	•	\$115,500

All playgrounds shown are in-ground mount and available as surface mount. Additional ground level components may be required for ADA and ASTM compliance.



**infiNET™ INET-2200**

INET-2200 • AGES: 5-12 • SPACE REQUIRED: 76' 6" X 62' 4"

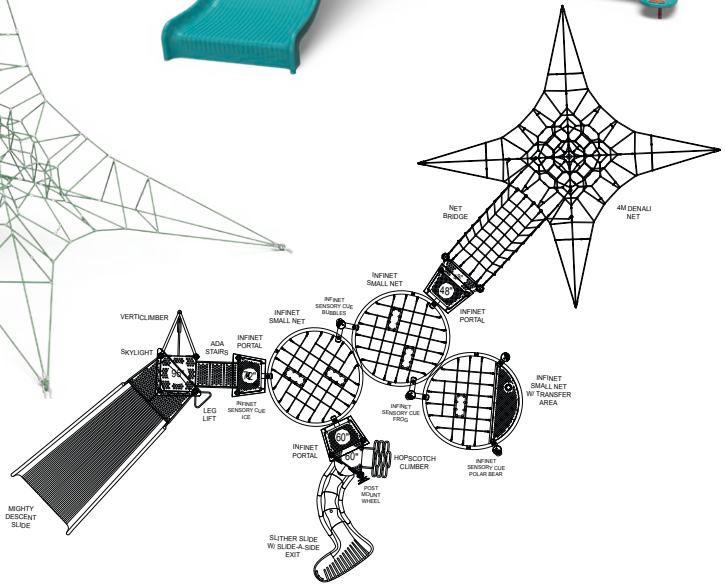
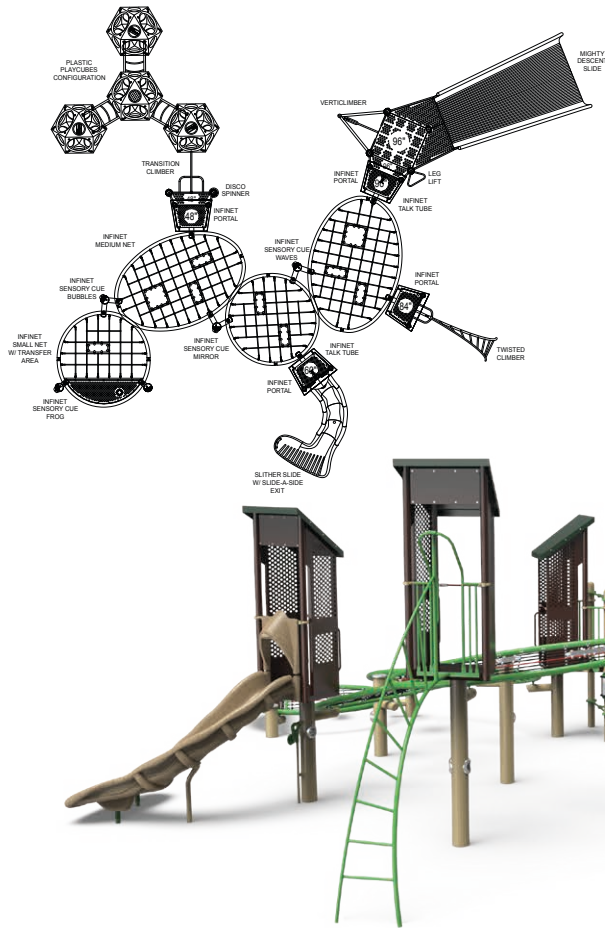

**infiNET™ INET-2210**

INET-2210 • AGES: 5-12 • SPACE REQUIRED: 61' 10" X 54' 4"

PRODUCT	ITEM	SPACE REQUIRED	SIZE	FALL HEIGHT	EVENTS	USERS	INSTALL HOURS	WEIGHT	ADA	ASTM F1487	CPSC PUB.235	CAV/CSA Z614	EN1176	APPROX. PRICE
infiNET™ INET-2200	INET-2200	76' 6" x 62' 4" (23,32m x 19m)	59' 11" x 50' 0" x 18' 2" (18,26m x 15,24m x 5,54m)	8' 0" (2,44m)	16	74	88	5693 lbs (2582 kg)	•	•	•	+		\$109,500
infiNET™ INET-2210	INET-2210	61' 10" x 54' 4" (18,85m x 16,56m)	48' 2" x 41' 11" x 16' 0" (14,68m x 12,78m x 4,88m)	8' 2" (2,49m)	23	104	86	7188 lbs (3260 kg)	•	•	•	+		\$119,000



Roy City U.S.A.  
300288056 S

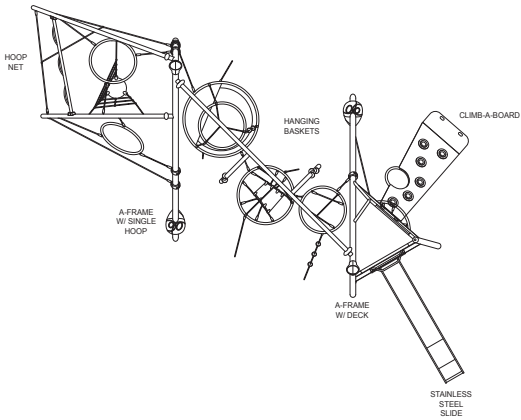

### Unity® Connect UC-2025

UC-2025 • AGES: 5-12 • SPACE REQUIRED: 44' 2" X 39' 10"

PRODUCT	ITEM	SPACE REQUIRED	SIZE	FALL HEIGHT	EVENTS	USERS	INSTALL HOURS	WEIGHT	ADA	ASTM F1487	CPSC PUB. 325	CAN/CSA Z614	EN1176	APPROX. PRICE
Unity® Connect UC-2025	UC-2025	44' 2" x 39' 10" (13,46m x 12,14m)	19' 0" x 21' 1" x 12' 10" (5,79m x 6,43m x 3,91m)	7' 2" (2,19m)	10	83	44	2709 lbs (1229 kg)	•	•	•	•	•	\$62,500

## Unity® Connect UC-1735

UC-1735 • AGES: 5-12 • SPACE REQUIRED: 46' 2" X 36' 7"

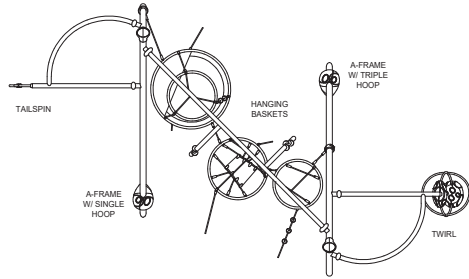
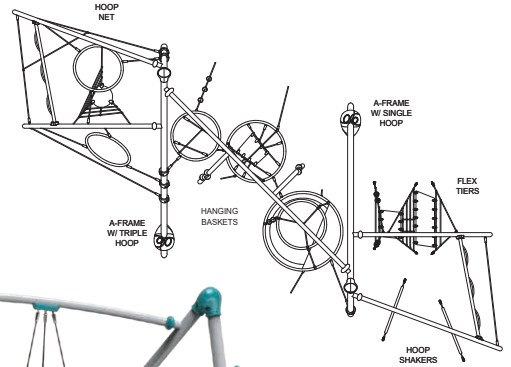

## Unity® Connect UC-1900

UC-1900 • AGES: 5-12 • SPACE REQUIRED: 44' 4" X 31' 2"

PRODUCT	ITEM	SPACE REQUIRED	SIZE	FALL HEIGHT	EVENTS	USERS	INSTALL HOURS	WEIGHT	ADA	ASTM F1487	CPSC PUB. 329	CAN/CSA Z614	EN1176	APPROX. PRICE
Unity® Connect UC-1735	UC-1735	46' 2" x 36' 7" (14,07m x 11,15m)	34' 0" x 24' 5" x 12' 10" (10,36m x 7,44m x 3,91m)	7' 2" (2,19m)	10	57	40	2278 lbs (1033 kg)	•	•	•	•	•	\$50,000
Unity® Connect UC-1900	UC-1900	44' 4" x 31' 2" (13,51m x 9,5m)	32' 1" x 18' 11" x 12' 10" (9,78m x 5,77m x 3,91m)	6' 7" (2,01m)	9	54	30	1824 lbs (827 kg)	•	•	•	•	•	\$37,000

All playgrounds shown are in-ground mount and available as surface mount. Additional ground level components may be required for ADA and ASTM compliance.

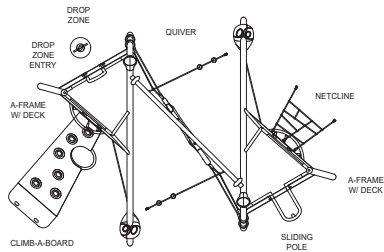

Unity® Connect UC-1730

UC-1730 • AGES: 5-12 • SPACE REQUIRED: 34' 10" X 27' 11"



Unity® Connect UC-2010

UC-2010 • AGES: 5-12 • SPACE REQUIRED: 30' 0" X 33' 4"

PRODUCT	ITEM	SPACE REQUIRED	SIZE	FALL HEIGHT	EVENTS	USERS	INSTALL HOURS	WEIGHT	ADA	ASTM F1487	CPSC PUB. 305	CAN/CSA Z614	EN1176	APPROX. PRICE
Unity® Connect UC-1730	UC-1730	34' 10" x 27' 11" (10,62m x 8,51m)	22' 9" x 15' 11" x 14' 9" (6,93m x 4,85m x 4,5m)	8' 2" (2,49m)	9	57	41	2681 lbs (1216 kg)	•	•	•	•	•	\$54,000
Unity® Connect UC-2010	UC-2010	30' 0" x 33' 4" (9,14m x 10,16m)	17' 9" x 21' 1" x 12' 10" (5,41m x 6,43m x 3,91m)	6' 1" (1,85m)	5	26	20	1398 lbs (634 kg)	•	•	•	•	•	\$38,000

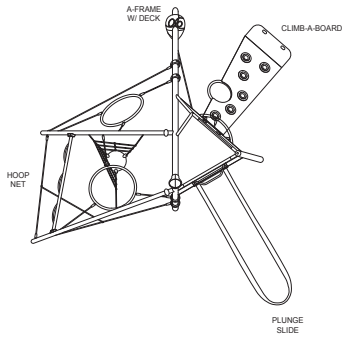

### Unity® Connect UC-2000

UC-2000 • AGES: 5-12 • SPACE REQUIRED: 31' 2" X 34' 0"

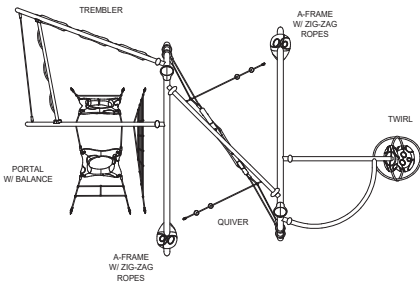

### Unity® Connect UC-1725

UC-1725 • AGES: 5-12 • SPACE REQUIRED: 40' 4" X 29' 4"

PRODUCT	ITEM	SPACE REQUIRED	SIZE	FALL HEIGHT	EVENTS	USERS	INSTALL HOURS	WEIGHT	ADA	ASTM F1487	CPSC PUB. 329	CAN./CSA Z614	EN1176	APPROX. PRICE
Unity® Connect UC-2000	UC-2000	31' 2" x 34' 0" (9,5m x 10,36m)	19' 0" x 21' 9" x 12' 10" (5,79m x 6,63m x 3,91m)	7' 2" (2,19m)	5	43	26.08	1611 lbs (731 kg)	•	•	•	•	•	\$30,000
Unity® Connect UC-1725	UC-1725	40' 4" x 29' 4" (12,29m x 8,94m)	28' 3" x 17' 3" x 12' 10" (8,61m x 5,26m x 3,91m)	8' 2" (2,49m)	8	49	29	1594 lbs (723 kg)	•	•	•	•	•	\$32,500





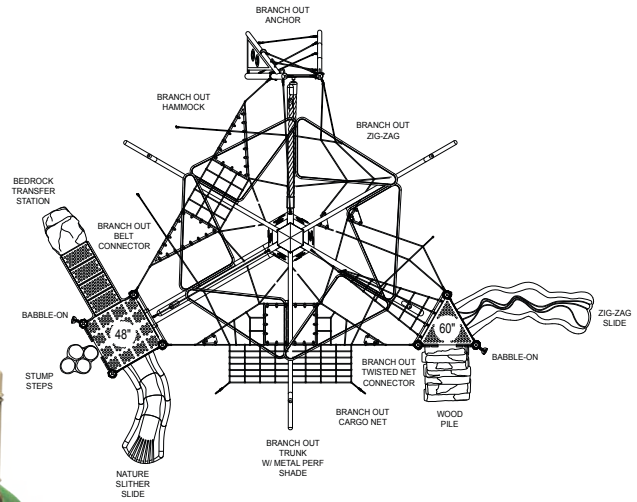

### Branch Out® Forest Hamlet

500-1953 • AGES: 5-12 • SPACE REQUIRED: 50' 8" X 42' 2"

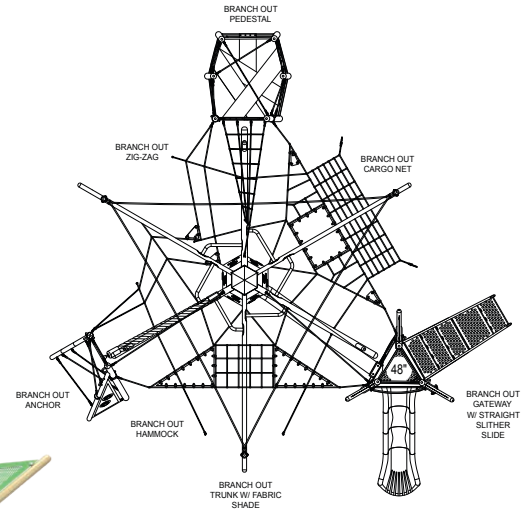

### Branch Out® Whistle Stop

500-1950 • AGES: 5-12 • SPACE REQUIRED: 44' 4" X 44' 4"

PRODUCT	ITEM	SPACE REQUIRED	SIZE	FALL HEIGHT	EVENTS	USERS	INSTALL HOURS	WEIGHT	ADA	ASTM F1487	CPSC PUB. 329	CAN./CSA Z614	EN1176	APPROX. PRICE
Branch Out® Forest Hamlet	500-1953	50' 8" x 42' 2" (15,44m x 12,85m)	38' 2" x 30' 0" x 16' 5" (11,63m x 9,14m x 5m)	6' 8" (2,04m)	13	60	61	8179 lbs (3710 kg)	•	•	•	+		\$123,000
Branch Out® Whistle Stop	500-1950	44' 4" x 44' 4" (13,51m x 13,51m)	32' 0" x 32' 2" x 16' 6" (9,75m x 9,81m x 5,03m)	6' 8" (2,04m)	8	50	60	5220 lbs (2368 kg)	•	•	•	•		\$100,500

All playgrounds shown are in-ground mount and available as surface mount. Additional ground level components may be required for ADA and ASTM compliance.



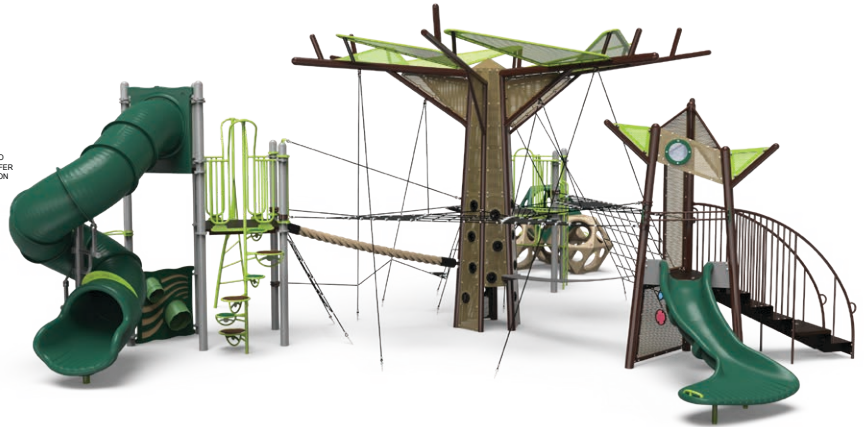
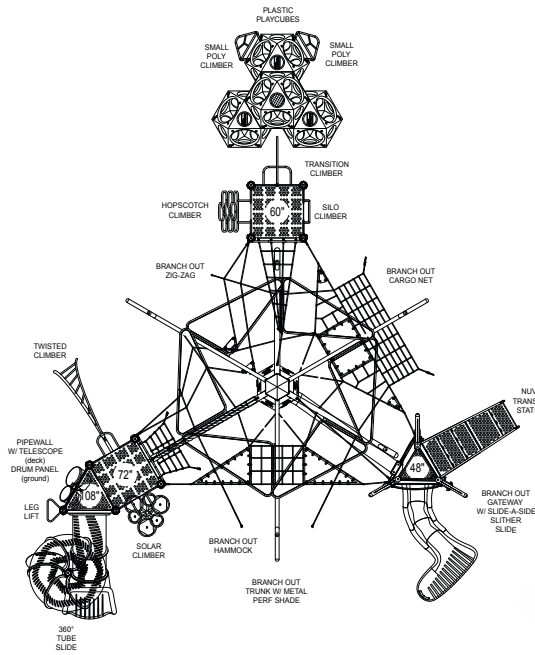

### Branch Out® Orchard

500-2350 • AGES: 5-12 • SPACE REQUIRED: 50' 0" X 59' 4"

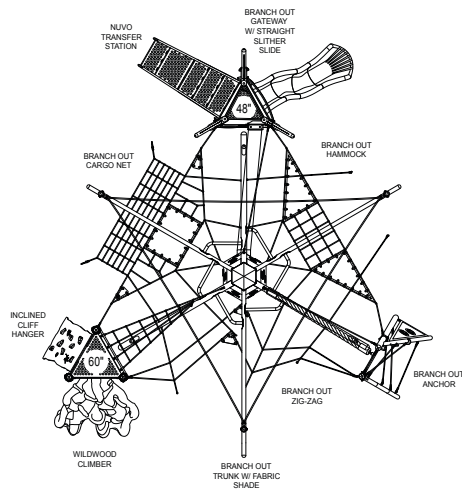

### Branch Out® Cal's Place

500-2050 • AGES: 5-12 • SPACE REQUIRED: 41' 0" X 43' 0"

PRODUCT	ITEM	SPACE REQUIRED	SIZE	FALL HEIGHT	EVENTS	USERS	INSTALL HOURS	WEIGHT	ADA	ASTM F1487	CPSC PUB.325	CAN/CSA Z614	EN1176	APPROX. PRICE
Branch Out® Orchard	500-2350	50' 0" x 59' 4" (15,24m x 18,08m)	27' 8" x 44' 10" x 16' 5" (8,43m x 13,66m x 5m)	8' 9" 0" (2,74m)	24	85	91.33	7399 lbs (3356 kg)	•	•	•	•	•	\$142,500
Branch Out® Cal's Place	500-2050	41' 0" x 43' 0" (12,5m x 13,11m)	28' 7" x 30' 10" x 16' 6" (8,71m x 9,4m x 5,03m)	6' 8" (2,03m)	10	55	65	5077 lbs (2303 kg)	•	•	•	•	•	\$100,000

All playgrounds shown are in-ground mount and available as surface mount. Additional ground level components may be required for ADA and ASTM compliance.

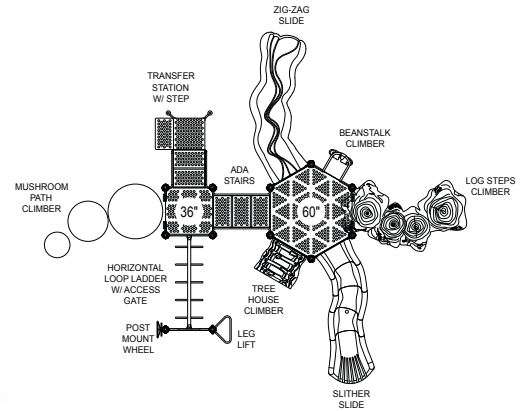

### Challengers® Jungle Excursion

350-2203 • AGES: 5-12 • SPACE REQUIRED: 39' 0" X 34' 6"

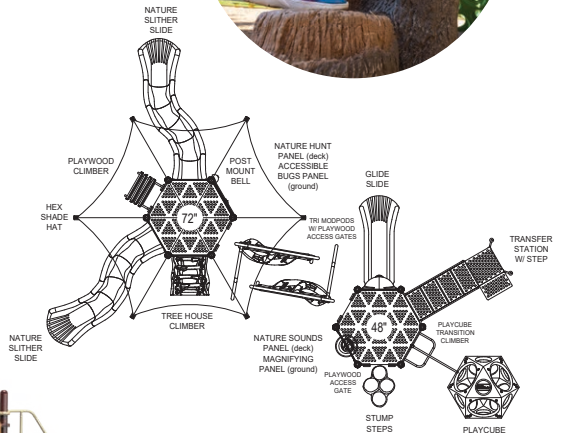

### Challengers® Camp Conifer

350-1908 • AGES: 5-12 • SPACE REQUIRED: 45' 2" X 38' 8"

PRODUCT	ITEM	SPACE REQUIRED	SIZE	FALL HEIGHT	EVENTS	USERS	INSTALL HOURS	WEIGHT	ADA	ASTM F1487	CPSC PUB. 305	CAN/CSA Z614	EN1176	APPROX. PRICE
Challengers® Jungle Excursion	350-2203	39' 0" x 34' 6" (11,89m x 10,52m)	26' 10" x 22' 4" x 10' 5" (8,18m x 6,81m x 3,18m)	8' 0" (2,44m)	9	35	37	2205 lbs (1000 kg)	•	•	•	+		\$47,000
Challengers® Camp Conifer	350-1908	45' 2" x 38' 8" (13,77m x 11,79m)	32' 9" x 26' 4" x 17' 5" (9,98m x 8,03m x 5,31m)	8' 9" (2,67m)	15	47	59	4846 lbs (2198 kg)	•	•	•	+		\$69,000

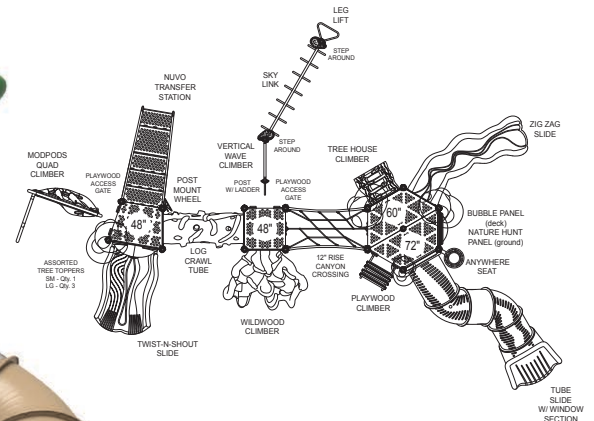

## Challengers® Penn's Woods

350-2003 • AGES: 5-12 • SPACE REQUIRED: 52' 0" X 39' 0"

PRODUCT	ITEM	SPACE REQUIRED	SIZE	FALL HEIGHT	EVENTS	USERS	INSTALL HOURS	WEIGHT	ADA	ASTM F1487	CPSC PUB. 325	CAN/CSA Z614	EN1176	APPROX. PRICE
Challengers® Penn's Woods	350-2003	52' 0" x 39' 0" (15,85m x 11,89m)	39' 10" x 26' 9" x 14' 2" (12,14m x 8,15m x 4,32m)	8' 5" (2,57m)	19	55	59	3425 lbs (1554 kg)	•	•	•	+		\$56,000

All playgrounds shown are in-ground mount and available as surface mount. Additional ground level components may be required for ADA and ASTM compliance.



Playground above has custom features. For more information, contact your local sales representative.

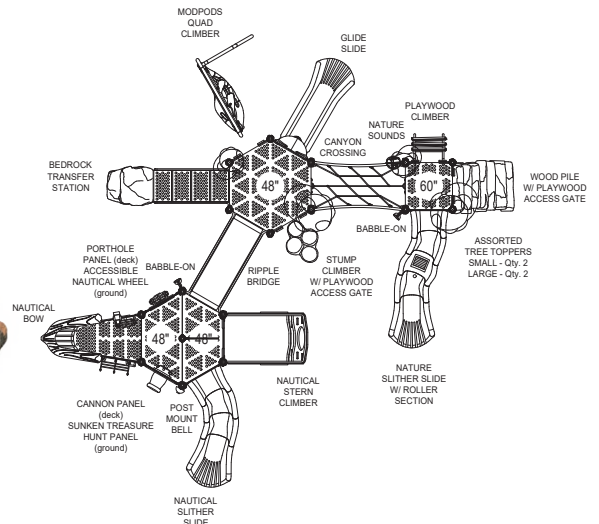

### Challengers® Pirate's Cove

350-1915 • AGES: 5-12 • SPACE REQUIRED: 42' 6" X 41' 0"

PRODUCT	ITEM	SPACE REQUIRED	SIZE	FALL HEIGHT	EVENTS	USERS	INSTALL HOURS	WEIGHT	ADA	ASTM F1487	CPSC PUB. 325	CAN/CSA Z614	EN1176	APPROX. PRICE
Challengers® Pirate's Cove	350-1915	42' 6" x 41' 0" (12,95m x 12,5m)	30' 1" x 28' 9" x 14' 2" (9,17m x 8,76m x 4,32m)	9' 0" (2,74m)	18	66	70	6462 lbs (2931 kg)	•	•	•	+		\$95,500

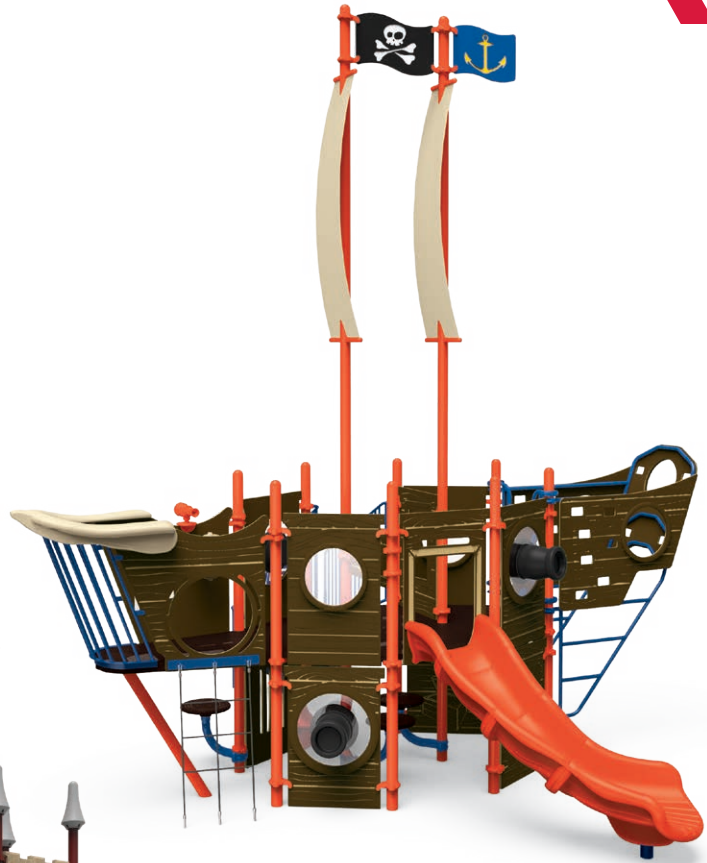
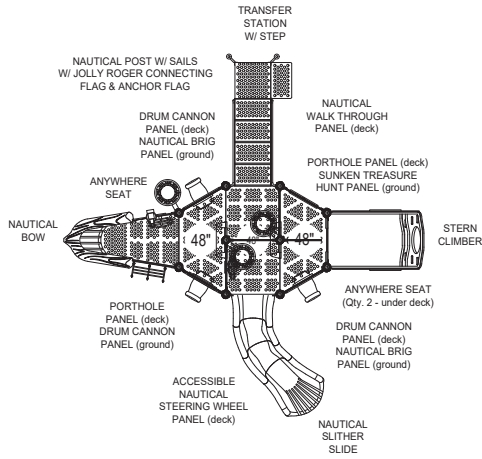

### Challengers® Ahoy Matey

350-1101 • AGES: 5-12 • SPACE REQUIRED: 32' 2" X 32' 1"

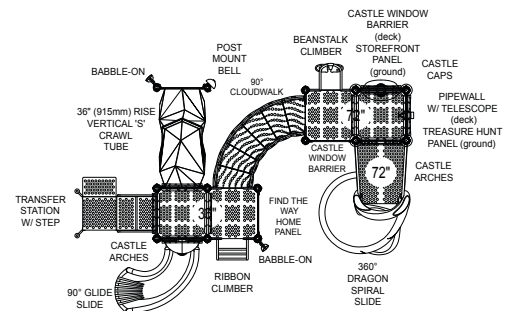

### Challengers® Sarah's Palace

350-2026 • AGES: 2-12 • SPACE REQUIRED: 32' 4" X 27' 2"

PRODUCT	ITEM	SPACE REQUIRED	SIZE	FALL HEIGHT	EVENTS	USERS	INSTALL HOURS	WEIGHT	ADA	ASTM F1487	CPSC PUB. 325	CMV/CSA Z614	EN1176	APPROX. PRICE
Challengers® Ahoy Matey	350-1101	32' 2" x 32' 1" (9,81m x 9,78m)	20' 0" x 20' 1" x 21' 1" (6,1m x 6,12m x 6,43m)	9' 0" (2,74m)	15	47	45	2447 lbs (1110 kg)	•	•	•	+	+	\$52,000
Challengers® Sarah's Palace	350-2026	32' 4" x 27' 2" (9,85m x 8,28m)	20' 2" x 14' 11" x 16' 9" (6,15m x 4,55m x 5,11m)	6' 0" (1,83m)	14	47	47	2676 lbs (1214 kg)	•	•	•	+		\$52,000

All playgrounds shown are in-ground mount and available as surface mount. Additional ground level components may be required for ADA and ASTM compliance.

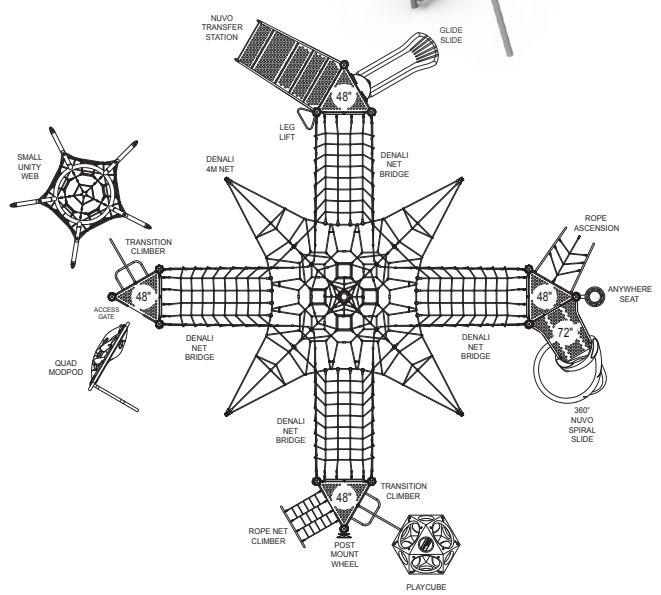

**Playmakers® Abigail's Maze**

500-2009 • AGES: 5-12 • SPACE REQUIRED: 56' 0" X 52' 8"

PRODUCT	ITEM	SPACE REQUIRED	SIZE	FALL HEIGHT	EVENTS	USERS	INSTALL HOURS	WEIGHT	ADA	ASTM F1487	CPSC PUB. 325	CAV/ CSA Z614	EN1176	APPROX. PRICE
Playmakers® Abigail's Maze	500-2009	56' 0" x 52' 8" (17,07m x 16,05m)	43' 7" x 40' 6" x 12' 10" (13,28m x 12,34m x 3,91m)	8' 5" (2,57m)	18	77	75	4714 lbs (2138 kg)	•	•	•	+	EN1176	\$117,000



## Playmakers® Cubes of Denali

500-2112 • AGES: 5-12 • SPACE REQUIRED: 60' 6" X 38' 6"

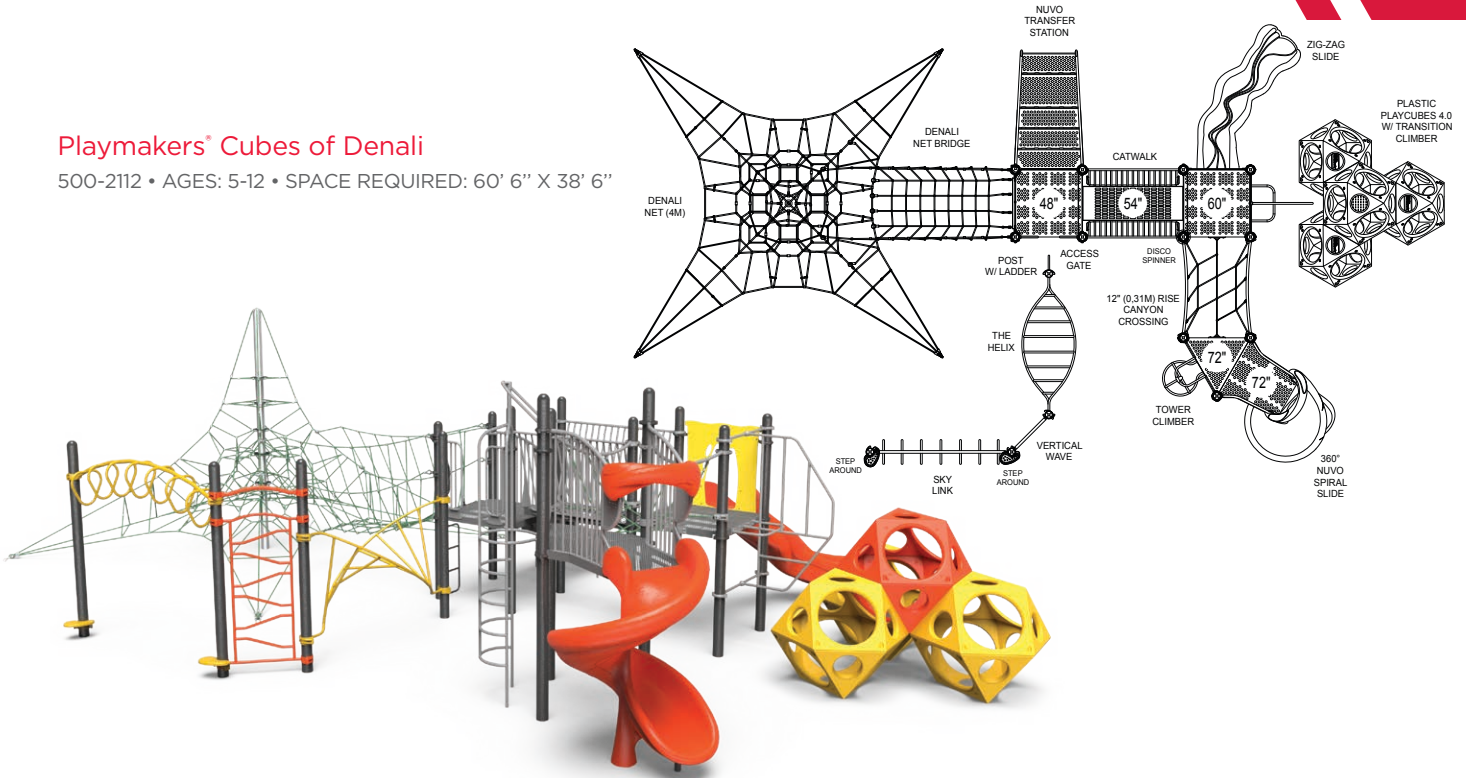

## Playmakers® Aria's Retreat

500-2006 • AGES: 5-12 • SPACE REQUIRED: 47' 6" X 56' 0"

PRODUCT	ITEM	SPACE REQUIRED	SIZE	FALL HEIGHT	EVENTS	USERS	INSTALL HOURS	WEIGHT	ADA	ASTM F1487	CPSC PUB. 325	CAN./CSA Z614	EN1176	APPROX. PRICE
Playmakers® Cubes of Denali	500-2112	60' 6" x 38' 6" (18,44m x 11,73m)	48' 3" x 26' 4" x 12' 10" (14,71m x 8,03m x 3,91m)	8' 0" (2,44m)	19	70	77	4588 lbs (2081 kg)	•	•	•	+		\$87,000
Playmakers® Aria's Retreat	500-2006	47' 6" x 56' 0" (14,48m x 17,07m)	34' 5" x 43' 1" x 12' 10" (10,49m x 13,13m x 3,91m)	8' 5" (2,57m)	10	45	62	3589 lbs (1628 kg)	•	•	•	•		\$68,500

All playgrounds shown are in-ground mount and available as surface mount. Additional ground level components may be required for ADA and ASTM compliance.

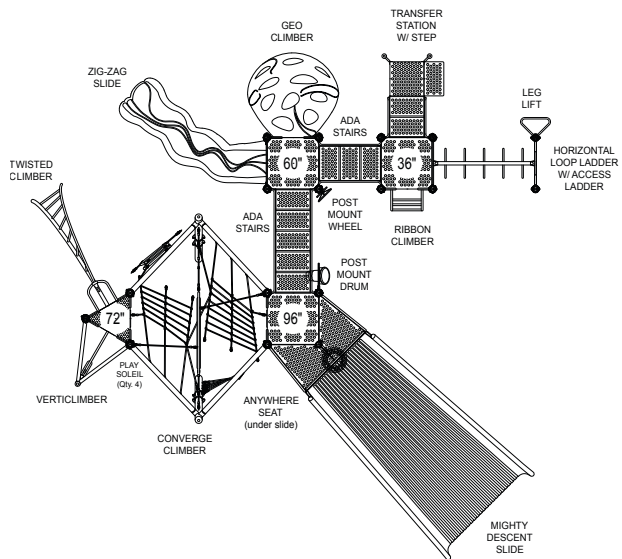

### Challengers® Adventure Mountain

350-2204\_PS • AGES: 5-12 • SPACE REQUIRED: 42' 6" X 43' 0"

PRODUCT	ITEM	SPACE REQUIRED	SIZE	FALL HEIGHT	EVENTS	USERS	INSTALL HOURS	WEIGHT	ADA	ASTM F1487	CPSC PUB. 325	CAN/CSA Z614	EN1176	APPROX. PRICE
Challengers® Adventure Mountain w/ PlaySoileil	350-2204_PS	42' 6" x 43' 0" (12,95m x 13,11m)	30' 4" x 29' 7" x 16' 0" (9,24m x 9,02m x 4,88m)	8' 8" 0" (2,44m)	12	54	58.33	3755 lbs (1703 kg)	•	•	•	+		\$56,000



### Playmakers® Monster Mash-Up

500-2300 • AGES: 5-12 • SPACE REQUIRED: 35' 0" X 37' 6"



### Challengers® Tree Frog Forest

350-2302 • AGES: 5-12 • SPACE REQUIRED: 51' 0" X 38' 0"

PRODUCT	ITEM	SPACE REQUIRED	SIZE	FALL HEIGHT	EVENTS	USERS	INSTALL HOURS	WEIGHT	ADA	ASTM F1487	CPSC PUB.305	CMV/CSA 2014	EN1176	APPROX. PRICE
Playmakers® Monster Mash-Up	500-2300	35' 0" x 37' 6" (10,67m x 11,43m)	25' 5" x 25' 2" x 11' 2" (7,75m x 7,67m x 3,4m)	8' 8" 0" (2,44m)	11	42	40.08	3041 lbs (1379 kg)	•	•	•	+		\$43,500
Challengers® Tree Frog Forest	350-2302	51' 0" x 38' 0" (15,54m x 11,58m)	36' 9" x 25' 7" x 14' 10" (11,2m x 7,8m x 4,52m)	8' 8" 0" (2,44m)	13	55	59.33	4106 lbs (1862 kg)	•	•	•	+		\$66,000

All playgrounds shown are in-ground mount and available as surface mount. Additional ground level components may be required for ADA and ASTM compliance.

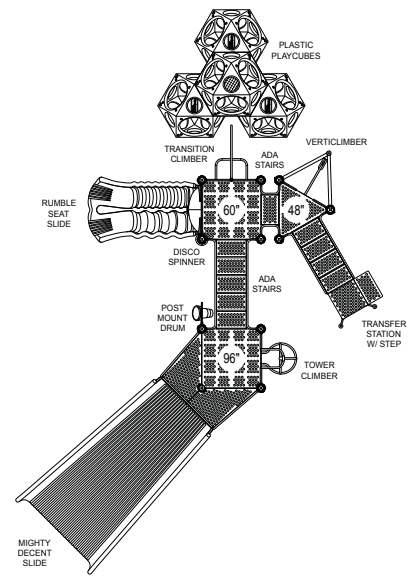

### Playmakers® Mighty Monarch

500-2301 • AGES: 5-12 • SPACE REQUIRED: 37' 6" X 50' 10"

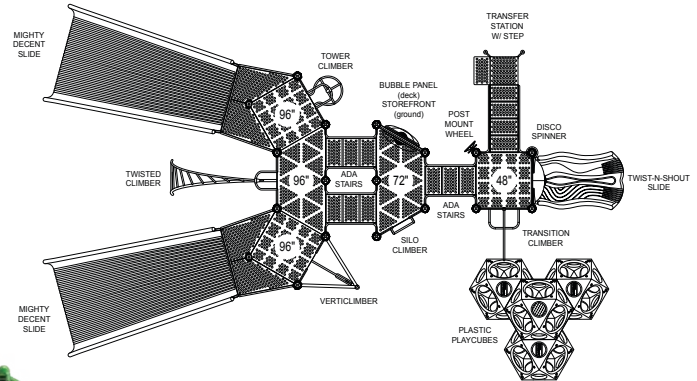

### Playmakers® Wavescape

500-2303 • AGES: 5-12 • SPACE REQUIRED: 55' 2" X 39' 2"

PRODUCT	ITEM	SPACE REQUIRED	SIZE	FALL HEIGHT	EVENTS	ADA	ASTM F1497	CPSC PUB.325	CMV/CSA Z614	EN1176	APPROX. PRICE
Playmakers® Mighty Monarch	500-2301	37' 6" x 50' 10" (11,43m x 15,49m)	24' 10" x 32' 2" x 13' 5" (7,57m x 9,81m x 4,09m)	8' 0" (2,44m)	11	•	•	•	+		\$55,500
Playmakers® Wavescape	500-2303	55' 2" x 39' 2" (16,82m x 11,94m)	41' 6" x 26' 10" x 14' 3" (12,65m x 8,18m x 4,34m)	8' 0" (2,44m)	15	•	•	•	+		\$83,500

+CSA and EN compliant versions available.

All play equipment must be installed over an appropriate impact absorbing surface that complies with ASTM or CSA standards. See your Playworld representative for more information.

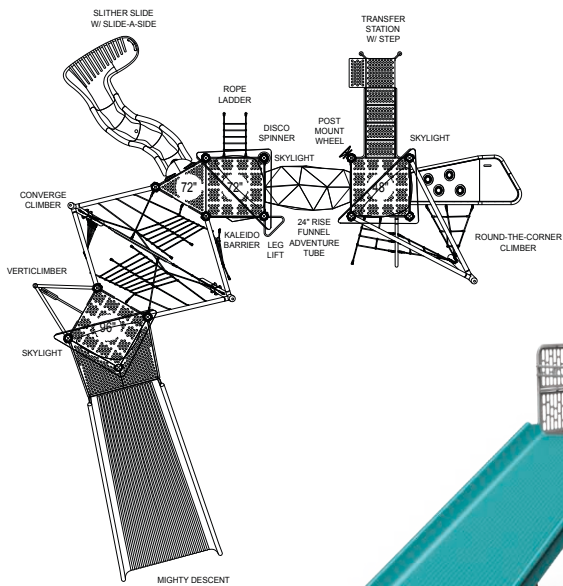

## Playmakers® Dynamic Rays

500-2188 • AGES: 5-12 • SPACE REQUIRED: 46' 0" X 51' 6"

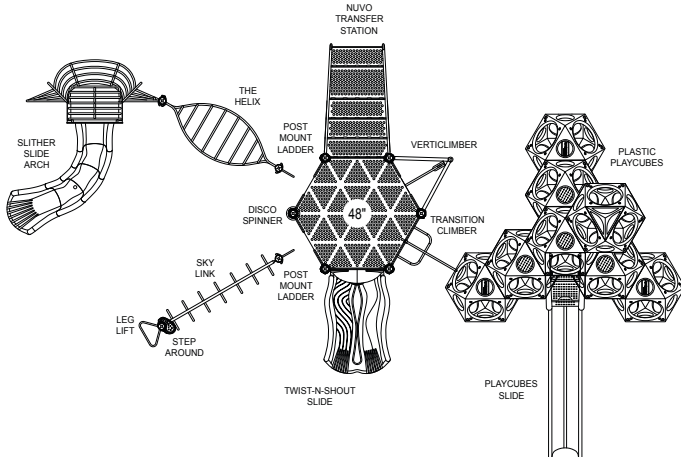

## Playmakers® Cubic Knot

500-2205 • AGES: 5-12 • SPACE REQUIRED: 54' 8" X 38' 4"

PRODUCT	ITEM	SPACE REQUIRED	SIZE	FALL HEIGHT	EVENTS	USERS	INSTALL HOURS	WEIGHT	ADA	ASTM F1487	CPSC PUB. 325	CAN./CSA Z614	EN1176	APPROX. PRICE
Playmakers® Dynamic Rays	500-2188	46' 0" x 51' 6" (14,02m x 15,7m)	33' 7" x 37' 6" x 19' 10" (10,24m x 11,43m x 6,04m)	8' 0" (2,44m)	11	63	60	5842 lbs (2650 kg)	•	•	•	•	•	\$79,500
Playmakers® Cubic Knot	500-2205	54' 8" x 38' 4" (16,66m x 11,68m)	42' 4" x 25' 11" x 10' 10" (12,9m x 7,9m x 3,3m)	8' 5" (2,57m)	21	65	43	3700 lbs (1678 kg)	•	•	•	•	•	\$67,500

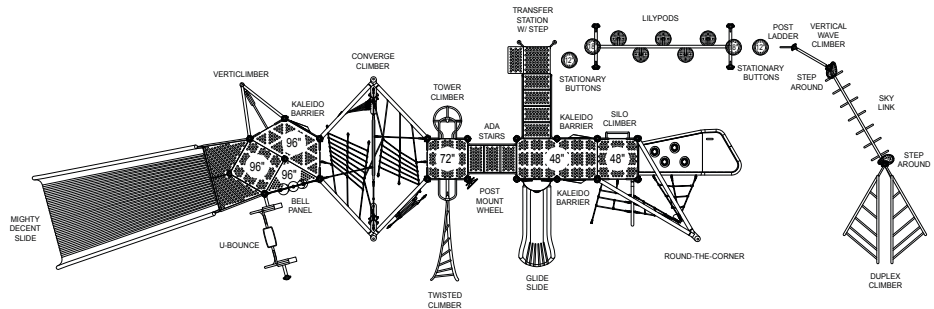

**Challengers® Rockin' Reef**

350-2304 • AGES: 5-12 • SPACE REQUIRED: 81' 0" X 31' 4"

PRODUCT	ITEM	SPACE REQUIRED	SIZE	FALL HEIGHT	EVENTS	USERS	INSTALL HOURS	WEIGHT	ADA	ASTM F1487	CPSC PUB.325 CAN/CSA Z614	EN1176	APPROX. PRICE
Challengers® Rockin' Reef	350-2304	81' 0" x 31' 4" (24,69m x 9,55m)	66' 6" x 19' 2" x 15' 10" (20,27m x 5,84m x 4,82m)	8' 0" (2,44m)	24	87	92.33	6163 lbs (2795 kg)	•	•	•	+	\$95,500



### Challengers® GeoScramble

350-1909 • AGES: 5-12 • SPACE REQUIRED: 58' 1" X 45' 4"

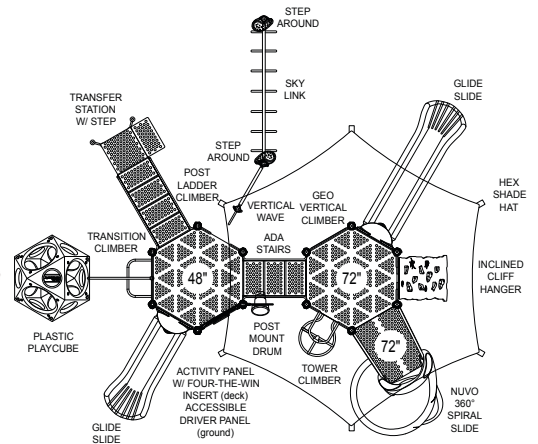
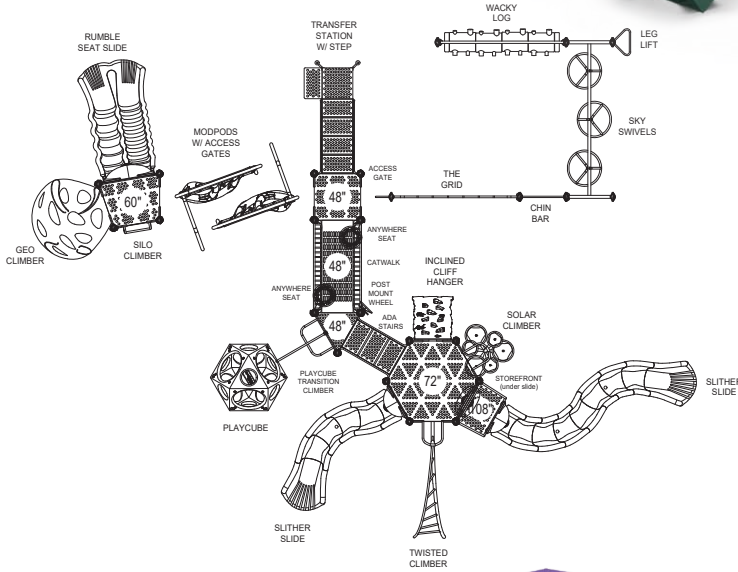

### Challengers® Trailblazer w/ Shade

350-2202 • AGES: 5-12 • SPACE REQUIRED: 38' 0" X 36' 4"

PRODUCT	ITEM	SPACE REQUIRED	SIZE	FALL HEIGHT	EVENTS	USERS	INSTALL HOURS	WEIGHT	ADA	ASTM F1487	CPSC PUB. 305	CAH/CSA Z614	EN1176	APPROX. PRICE
Challengers® GeoScramble	350-1909	58' 1" x 45' 4" (17,7m x 13,82m)	42' 11" x 33' 0" x 13' 10" (13,09m x 10,06m x 4,22m)	9' 0" (2,74m)	24	67	78	4830 lbs (2191 kg)	•	•	•	+		\$77,500
Challengers® Trailblazer w/ Shade	350-2202	38' 0" x 36' 4" (11,58m x 11,07m)	25' 11" x 24' 1" x 17' 5" (7,9m x 7,34m x 5,31m)	8' 0" (2,44m)	16	45	56	4125 lbs (1871 kg)	•	•		+		\$53,500

All playgrounds shown are in-ground mount and available as surface mount. Additional ground level components may be required for ADA and ASTM compliance.

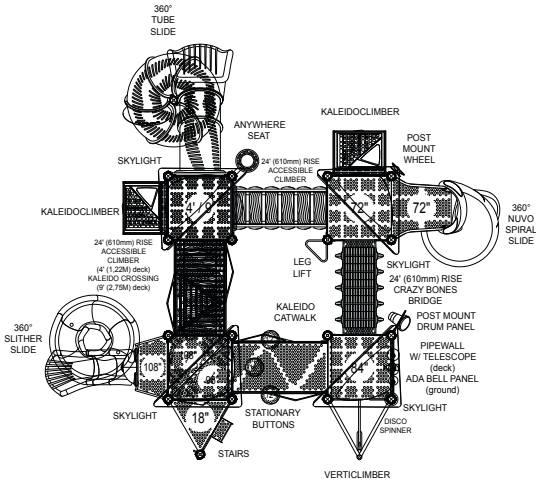

Playmakers® FUNderstorm

500-2305 • AGES: 5-12 • SPACE REQUIRED: 42' 10" X 40' 7"

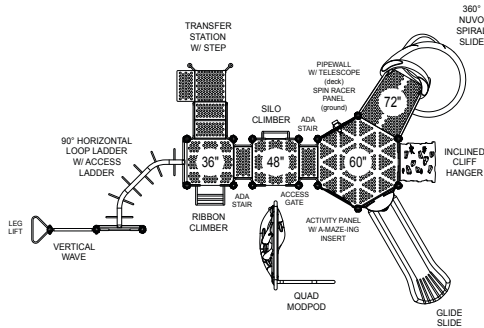

Challengers® Jack's Journey

350-2104 • AGES: 5-12 • SPACE REQUIRED: 40' 2" X 30' 0"

PRODUCT	ITEM	SPACE REQUIRED	SIZE	FALL HEIGHT	EVENTS	USERS	INSTALL HOURS	WEIGHT	ADA	ASTM F1487	CPSC PUB.325	CAN/CSA Z614	EN1176	APPROX. PRICE
Playmakers® FUNderstorm	500-2305	42' 10" x 40' 7" (13,05m x 12,37m)	26' 6" x 26' 1" x 18' 1" (8,08m x 7,95m x 5,51m)	9' 0" (2,74m)	21	67	75.86	7814 lbs (3544 kg)	•	•	•	+		\$129,500
Challengers® Jack's Journey	350-2104	40' 2" x 30' 0" (12,24m x 9,14m)	28' 1" x 17' 5" x 10' 6" (8,56m x 5,31m x 3,2m)	8' 5" (2,57m)	12	40	51	3017 lbs (1368 kg)	•	•	•	+		\$41,000





PlaySoleil

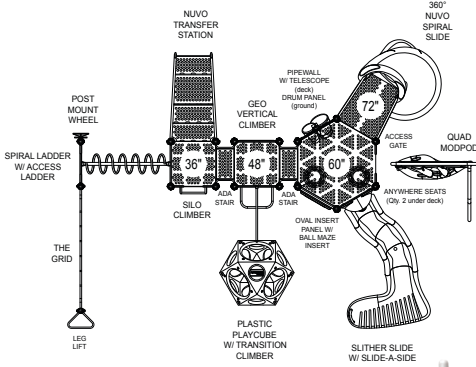
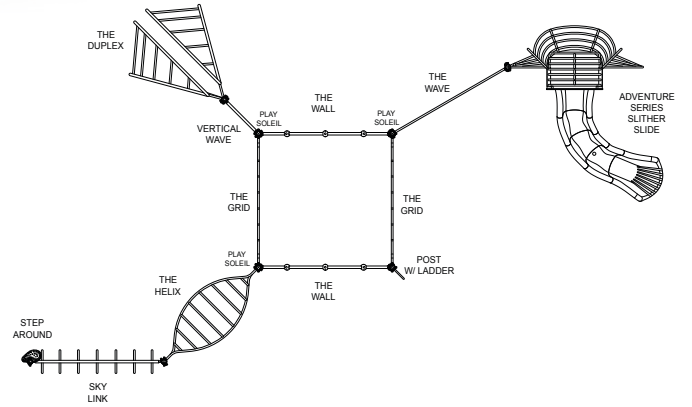
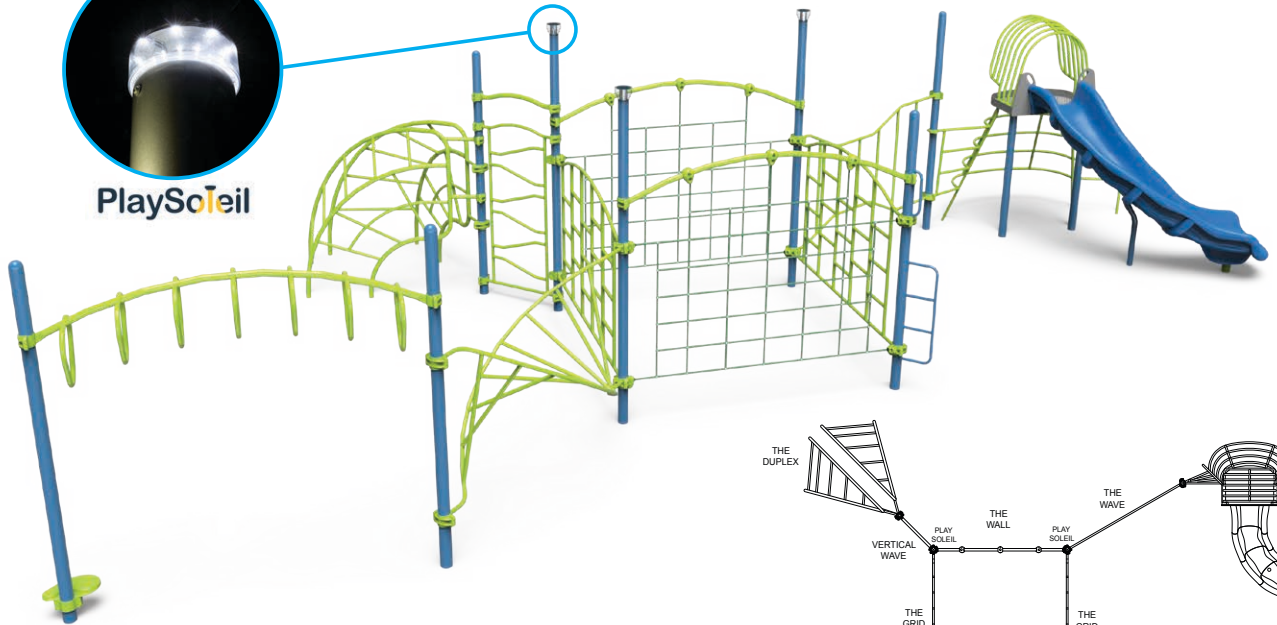

### Challengers® Maycee's Maze

350-2103\_PS • AGES: 5-12 • SPACE REQUIRED: 50' 8" X 35' 0"



### Challengers® Amelia's Expedition

350-2107 • AGES: 5-12 • SPACE REQUIRED: 39' 4" X 31' 10"

PRODUCT	ITEM	SPACE REQUIRED	SIZE	FALL HEIGHT	EVENTS	USERS	INSTALL HOURS	WEIGHT	ADA	ASTM F1487	CPSC PUB. 325	CAN/CSA Z614	EN1176	APPROX. PRICE
Challengers® Maycee's Maze w/ PlaySoleil	350-2103_PS	52' 0" x 35' 0" (15,85m x 10,67m)	39' 10" x 22' 11" x 9' 8" (12,14m x 6,99m x 2,95m)	7' 10" (2,39m)	13	29	20.58	1674 lbs (760 kg)	•	•	•	+		\$36,500
Challengers® Amelia's Expedition	350-2107	39' 4" x 31' 10" (11,99m x 9,7m)	27' 3" x 19' 3" x 10' 6" (8,31m x 5,87m x 3,2m)	8' 5" (2,57m)	16	46	55	3330 lbs (1511 kg)	•	•	•	+		\$48,500

All playgrounds shown are in-ground mount and available as surface mount. Additional ground level components may be required for ADA and ASTM compliance.



Challengers® Hap's Happening

350-2101



Challengers® Leila's Landing

350-2102



Playmakers® Superhero

500-1719



Challengers® Hattie's Hideout

350-2000



Challengers® Aanyah's Adventure

350-2100\_PS



Challengers® Up & Over

350-2200

PRODUCT	ITEM	SPACE REQUIRED	SIZE	FALL HEIGHT	EVENTS	USERS	INSTALL HOURS	WEIGHT	ADA	ASTM F1487	CPSC PUB.325	CAN/CSA Z614	EN1176	APPROX. PRICE
Challengers® Hap's Happening	350-2101	39' 2" x 29' 6" (11,94m x 8,99m)	27' 1" x 17' 5" x 11' 5" (8,25m x 5,31m x 3,48m)	6' 0" (1,83m)	11	32	32	2039 lbs (925 kg)	•	•	•	+		\$34,000
Challengers® Leila's Landing	350-2102	38' 6" x 34' 6" (11,73m x 10,52m)	26' 5" x 22' 6" x 9' 6" (8,05m x 6,86m x 2,9m)	4' 1" (1,24m)	10	36	38	2121 lbs (962 kg)	•	•	•	+		\$34,000
Playmakers® Superhero	500-1719	29' 7" x 31' 1" (9,02m x 9,47m)	17' 5" x 18' 11" x 11' 2" (5,31m x 5,77m x 3,4m)	8' 0" (2,44m)	7	28	38	2673 lbs (1213 kg)	•	•	•	+	+	\$32,000
Challengers® Hattie's Hideout	350-2000	35' 0" x 28' 0" (10,67m x 8,53m)	22' 9" x 15' 8" x 11' 5" (6,93m x 4,78m x 3,48m)	8' 5" (2,57m)	7	23	29	1735 lbs (787 kg)	•	•	•	+	+	\$27,500
Challengers® Aanyah's Adventure w/ PlaySoleil	350-2100_PS	47' 4" x 39' 4" (14,43m x 11,99m)	35' 1" x 27' 2" x 9' 8" (10,69m x 8,28m x 2,95m)	7' 10" (2,39m)	9	19	21.08	1674 lbs (759 kg)	•	•	•	+		\$27,500
Challengers® Up & Over	350-2200	36' 0" x 27' 6" (10,97m x 8,38m)	23' 9" x 15' 3" x 13' 8" (7,24m x 4,65m x 4,17m)	5' 3" (1,6m)	9	33	30	1797 lbs (815 kg)	•	•	•	+		\$27,500

+CSA and EN compliant versions available.

All play equipment must be installed over an appropriate impact absorbing surface that complies with ASTM or CSA standards. See your Playworld representative for more information.



### PlaySimple® Eagle Summit

PSD-1105-FTD

PlaySimple color palettes:



### PlaySimple® Mega Tunnel Junction

PSD-1104-FTD



### PlaySimple® Rock-N-Slide

PSD-1103-FTD



### PlaySimple® Lookout Point

PSD-1106-FTD

PRODUCT	ITEM	SPACE REQUIRED	SIZE	FALL HEIGHT	EVENTS	USERS	INSTALL HOURS	WEIGHT	ADA	ASTM F1487	CPSC PUB.325	CAN./USA 2614	EN1176	APPROX. PRICE
PlaySimple® Eagle Summit	PSD-1105-FTD	37' 5" x 33' 2" (11,41m x 10,11m)	25' 5" x 21' 2" x 13' 0" (7,75m x 6,45m x 3,96m)	6' 0" (1,83m)	11	28	26	2443 lbs (1108 kg)	•	•	•	+	•	\$24,802
PlaySimple® Mega Tunnel Junction	PSD-1104-FTD	30' 7" x 32' 5" (9,32m x 9,88m)	18' 7" x 20' 5" x 13' 0" (5,66m x 6,22m x 3,96m)	6' 0" (1,83m)	11	28	26	2171 lbs (985 kg)	•	•	•	+	•	\$22,202
PlaySimple® Rock-N-Slide	PSD-1103-FTD	30' 6" x 25' 3" (9,3m x 7,7m)	18' 6" x 13' 3" x 13' 0" (5,64m x 4,04m x 3,96m)	6' 0" (1,83m)	7	19	18	1621 lbs (736 kg)	•	•	•	+	•	\$15,494
PlaySimple® Lookout Point	PSD-1106-FTD	37' 5" x 40' 2" (11,41m x 12,24m)	25' 5" x 28' 2" x 13' 0" (7,75m x 8,59m x 3,96m)	6' 0" (1,83m)	15	37	34	2992 lbs (1357 kg)	•	•	•	+	•	\$31,510





## Early Childhood

The first few years of a child's life are the most crucial periods for learning, so we pack our early childhood products with features to help them grow.

- 92 **PlayTown™**
- 98 **Infant Fun Centers™**
- 99 **FirstPlay™ Toddler**
- 100 **Fun Centers™**
- 102 **Climbing Squares**
- 104 **Modern**
- 108 **Themed**
- 112 **Classic**
- 115 **PlaySimple®**



Community Helpers w/ Tunnel

ZZXX0880 • AGES: 2-5 \*Patent pending

TOP INCLUSIVE PRODUCT



Silly Tree

ZZXX0885 • AGES: 2-5

\*Patent D943700

TOP INCLUSIVE PRODUCT



Traffic Light

ZZXX0886 • AGES: 2-5

TOP INCLUSIVE PRODUCT



Garden Sensory Wall for 2 Inserts

ZZXX0884 • AGES: 2-5

\*Inserts sold separately. Additional inserts on page 196

TOP INCLUSIVE PRODUCT



Playhouse

\*Patent D943698

ZZXX0882 • AGES: 2-5

TOP INCLUSIVE PRODUCT



Chatterly

ZZXX0887 • AGES: 2-5

TOP INCLUSIVE PRODUCT



Truck

\*Patent D956884

ZZXX0881 • AGES: 2-5

TOP INCLUSIVE PRODUCT



Garden Crawl Tunnel

ZZXX0883 • AGES: 2-5

TOP INCLUSIVE PRODUCT

PRODUCT	ITEM	SPACE REQUIRED	SIZE	FALL HEIGHT	EVENTS	USERS	INSTALL HOURS	WEIGHT	ADA	ASTM F1487	CPSC PUB 325	CAV/CSA Z614	EN1176	APPROX. PRICE
PlayTown™ Community Helpers w/ Tunnel	ZZXX0880	28' 11" x 22' 3" (8,81m x 6,78m)	16' 11" x 10' 4" x 7' 11" (5,15m x 3,14m x 2,41m)	3' 4" (1,01m)	12	20	12	1704 lbs (773 kg)	•	•	•	•	•	\$19,181
PlayTown™ Silly Tree	ZZXX0885	18' 10" x 17' 0" (5,74m x 5,18m)	10' 10" x 5' 7" x 7' 2" (3,29m x 1,71m x 2,19m)	0' 8" (0,21m)	12	18	6	854 lbs (387 kg)	•	•	•	•	•	\$12,209
PlayTown™ Playhouse	ZZXX0882	16' 5" x 15' 5" (5m x 4,7m)	9' 5" x 5' 8" x 5' 6" (2,87m x 1,74m x 1,68m)	0' 8" (0,21m)	18	20	10	859 lbs (390 kg)	•	•	•	•	•	\$11,904
PlayTown™ Traffic Light	ZZXX0886	1' 1" x 0' 5" (0,33m x 0,13m)	1' 2" x 0' 6" x 3' 2" (0,37m x 0,15m x 0,98m)	-	1	2	2	54 lbs (25 kg)	•	•	•	•	•	\$1,292
PlayTown™ Garden Sensory Wall for 2 Inserts	ZZXX0884	4' 7" x 0' 9" (1,4m x 0,23m)	4' 7" x 0' 10" x 2' 10" (1,4m x 0,24m x 0,85m)	-	5	8	2	157 lbs (72 kg)	•	•	•	•	•	\$1,749
PlayTown™ Truck	ZZXX0881	6' 0" x 2' 9" (1,83m x 0,84m)	6' 0" x 2' 11" x 5' 7" (1,83m x 0,88m x 1,71m)	-	6	6	8	269 lbs (122 kg)	•	•	•	•	•	\$4,457
PlayTown™ Garden Crawl Tunnel	ZZXX0883	16' 5" x 16' 7" (5m x 5,05m)	4' 5" x 4' 5" x 2' 10" (1,34m x 1,34m x 0,85m)	0' 4" (0,09m)	4	8	2	255 lbs (116 kg)	•	•	•	•	•	\$2,672
PlayTown™ Chatterly	ZZXX0887	8' 5" x 4' 2" (2,57m x 1,27m)	8' 5" x 4' 0" x 6' 11" (2,56m x 1,22m x 2,1m)	1' 1" (0,34m)	2	10	10	588 lbs (267 kg)	•	•	•	•	•	\$6,975

+CSA and EN compliant versions available.

All play equipment must be installed over an appropriate impact absorbing surface that complies with ASTM or CSA standards. See your Playworld representative for more information.







## Playground

ZZXX0474 • AGES: 2-5



### Music Store

ZZXX0475 • AGES: 2-5



### Toll Booth

ZZXX0478 • AGES: 2-5



### Gas Station

ZZXX0477 • AGES: 2-5



### Nature Station

ZZXX0476 • AGES: 2-5



1



2



3



4



5



6

### Trike Path Signs AGES: 2-5

1. Traffic Light ZZPD3450
2. Accessible Sign ZZPD3400
3. School Zone Sign ZZPD3410
4. Speed Limit 5 Sign ZZPD3390
5. Stop Sign ZZPD3370
6. Yield Sign ZZPD3380

PRODUCT	ITEM	SPACE REQUIRED	SIZE	FALL HEIGHT	EVENTS	USERS	INSTALL HOURS	WEIGHT	ADA	ASTM F1487	CPSC PUB.325	CAW/CSA 2514	EN1176	APPROX. PRICE
PlayTown™ Playground	ZZXX0474	21' 7" x 20' 1" (6,58m x 6,12m)	9' 7" x 8' 1" x 7' 10" (2,92m x 2,46m x 2,39m)	2' 8" (0,81m)	5	7	8	448 lbs (204 kg)	•	•	•	•	•	\$7,925
PlayTown™ Music Store	ZZXX0475	-	4' 0" x 6' 9" x 6' 6" (1,22m x 2,06m x 1,98m)	-	7	7	5	230 lbs (105 kg)	•	•	•	•	•	\$5,915
PlayTown™ Toll Booth	ZZXX0478	-	2' 3" x 4' 2" x 5' 4" (0,69m x 1,27m x 1,62m)	-	2	2	3	71 lbs (33 kg)	•	•	•	•	•	\$2,075
PlayTown™ Gas Station	ZZXX0477	-	3' 10" x 4' 2" x 5' 4" (1,17m x 1,27m x 1,62m)	-	5	5	4	109 lbs (50 kg)	•	•	•	•	•	\$4,089
PlayTown™ Nature Station	ZZXX0476	-	4' 6" x 4' 0" x 6' 8" (1,37m x 1,22m x 2,03m)	-	5	4	4	225 lbs (102 kg)	•	•	•	•	•	\$5,235

### PlayTown™ Emily's Playhouse

IDEA-2002 • AGES: 2-5 • SPACE REQUIRED: 35' 7" X 26' 2"



### PlayTown™ Oscar's Farm

IDEA-2003 • AGES: 2-5 • SPACE REQUIRED: 49' 6" X 28' 6"

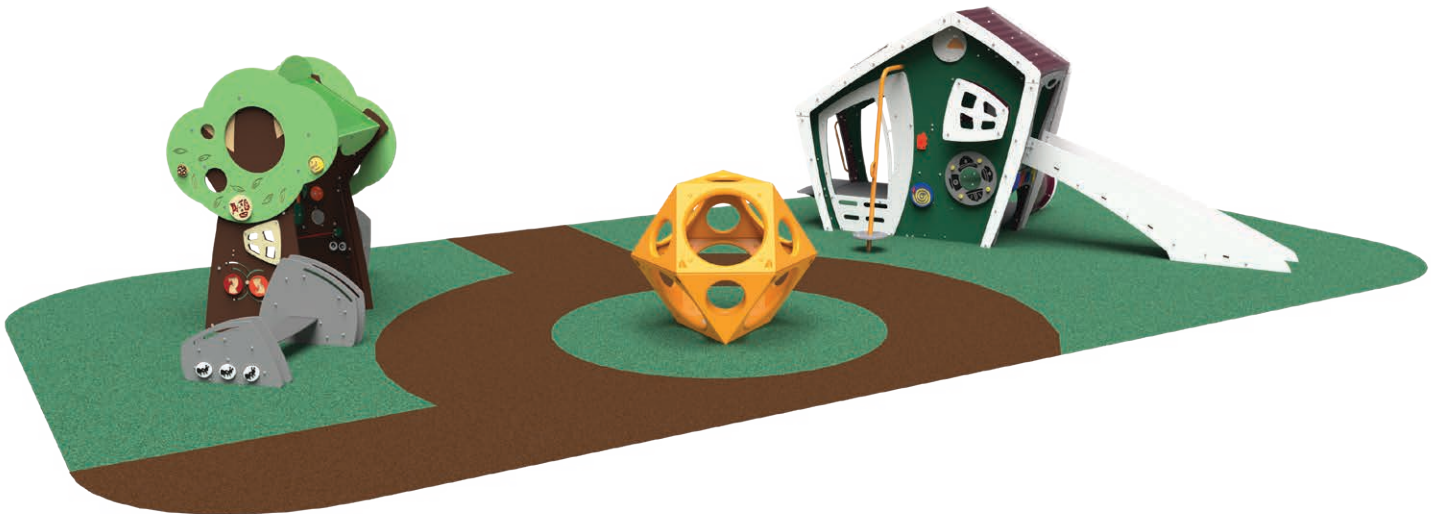

PRODUCT	ITEM	SPACE REQUIRED	SIZE	FALL HEIGHT	EVENTS	USERS	INSTALL HOURS	WEIGHT	ADA	ASTM F1487	CPSC PUB. 305	CAN/CSA Z614	EN1176	APPROX. PRICE
PlayTown™ Emily's Playhouse	IDEA-2002	35' 7" x 26' 2" (10,84m x 7,98m)	-	4' 8" (1,42m)	29	44	35	1651 lbs (749 kg)	•	•	•	•	•	\$28,000
PlayTown™ Oscar's Farm	IDEA-2003	49' 6" x 28' 6" (15,09m x 8,69m)	-	4' 1" (1,24m)	25	42	26	2709 lbs (1229 kg)	•	•	•	•	•	\$35,500

+CSA and EN compliant versions available.

All play equipment must be installed over an appropriate impact absorbing surface that complies with ASTM or CSA standards. See your Playworld representative for more information.

### PlayTown™ Riley's Rescue

IDEA-2000 • AGES: 2-5 • SPACE REQUIRED: 45' 6" X 28' 6"



### PlayTown™ Butterfly Garden

IDEA-2001 • AGES: 2-5 • SPACE REQUIRED: 32' 0" X 26' 2"



PRODUCT	ITEM	SPACE REQUIRED	SIZE	FALL HEIGHT	EVENTS	USERS	INSTALL HOURS	WEIGHT	ADA	ASTM F1487	CPSC PUB. 329	CAN./CSA Z614	EN1176	APPROX. PRICE
PlayTown™ Riley's Rescue	IDEA-2000	45' 6" x 28' 6" (13,87m x 8,69m)	-	4' 0" (1,22m)	17	44	73	3114 lbs (1412 kg)	•	•	•	•	•	\$44,000
PlayTown™ Butterfly Garden	IDEA-2001	32' 0" x 26' 2" (9,75m x 7,98m)	-	0' 10" (0,25m)	23	32	22	1274 lbs (578 kg)	•	•	•	•	•	\$19,000

All playgrounds shown are in-ground mount and available as surface mount. Additional ground level components may be required for ADA and ASTM compliance.

### FirstPlay™ Infant Fun Center

ZZPD5236 • AGES: 6-23 MONTHS

- Fun activity center caters to crawlers and walkers alike, offering bright colors and distinct textures to entertain babies
- Choose from the color palettes shown
- Removable panels make it easy to clean



Contains 12 developmentally-appropriate activities, including a winding ball track, counting and sorting activities, an artwork frame, and more!

FirstPlay Infant Color Palettes:



### Infant Fun Center

ZZPD5051 • AGES: 6-23 MONTHS

- Nautically-themed play center features spinning sea shapes and shatterproof, non-glass mirror
- Colors as shown
- To surface mount, order two anchor stakes/bolts

PRODUCT	ITEM	SPACE REQUIRED**	SIZE	FALL HEIGHT	EVENTS	USERS	INSTALL HOURS	WEIGHT	ADA	ASTM F2373	CPSC PUB. 325	CAN/CSA Z614	EN1176	APPROX. PRICE
FirstPlay™ Infant Fun Center	ZZPD5236	12' 4" x 11' 6" (3,77m x 3,49m)	5' 6" x 6' 4" x 2' 5" (1,68m x 1,94m x 0,75m)	0' 9" (0,23m)	12	8	1	142 lbs (65 kg)	•	•				\$3,755
Infant Fun Center	ZZPD5051	12' 6" x 9' 3" (3,81m x 2,82m)	6' 5" x 3' 0" x 1' 11" (1,96m x 0,91m x 0,59m)	0' 6" (0,15m)	5	6	2	217 lbs (99 kg)	•					\$5,025

+CSA and EN compliant versions available.

All play equipment must be installed over an appropriate impact absorbing surface that complies with ASTM or CSA standards. See your Playworld representative for more information.

FirstPlay Toddler Color Palettes:



FirstPlay™ Toddler Design #5  
FP-525 • AGES: 6-23 MONTHS



FirstPlay™ Toddler Design #3  
FP-515 • AGES: 6-23 MONTHS



FirstPlay™ Toddler Design #8  
FP-540 • AGES: 6-23 MONTHS



FirstPlay™ Toddler Design #7  
FP-535 • AGES: 6-23 MONTHS

PRODUCT	ITEM	SPACE REQUIRED**	SIZE	FALL HEIGHT	EVENTS	USERS	INSTALL HOURS	WEIGHT	ADA	ASTM F2372	CPSC PUB.325	CMV/CSA Z614	EN1176	APPROX. PRICE
FirstPlay™ Toddler Design #5	FP-525	18' 6" x 14' 7" (5,64m x 4,44m)	12' 6" x 8' 7" x 5' 0" (3,81m x 2,62m x 1,52m)	1' 6" (0,46m)	6	9	4	191 lbs (87 kg)	•	•	•			\$6,263
FirstPlay™ Toddler Design #3	FP-515	14' 9" x 14' 6" (4,5m x 4,42m)	8' 8" x 8' 7" x 5' 0" (2,64m x 2,62m x 1,52m)	1' 6" (0,46m)	4	6	3	140 lbs (64 kg)	•	•	•			\$4,455
FirstPlay™ Toddler Design #8	FP-540	21' 6" x 13' 8" (6,55m x 4,17m)	15' 6" x 7' 8" x 5' 0" (4,72m x 2,34m x 1,52m)	1' 6" (0,46m)	8	14	4	330 lbs (150 kg)	•	•	•			\$9,778
FirstPlay™ Toddler Design #7	FP-535	25' 3" x 15' 1" (7,7m x 4,6m)	19' 3" x 9' 1" x 5' 0" (5,87m x 2,77m x 1,52m)	1' 6" (0,46m)	9	17	5	366 lbs (166 kg)	•	•	•			\$10,723

All playgrounds shown are in-ground mount and available as surface mount. Additional ground level components may be required for ADA and ASTM compliance.

Fun Centers™ Color Palettes:



Fun Centers™ Design #5  
FC02-708 • AGES: 2-5



Fun Centers™ Design #1  
FC02-700 • AGES: 2-5



Fun Centers™ Design #2  
FC02-702 • AGES: 2-5

PRODUCT	ITEM	SPACE REQUIRED	SIZE	FALL HEIGHT	EVENTS	USERS	INSTALL HOURS	WEIGHT	ADA	ASTM F1487	CPSC PUB.325	CAN/CSA Z614	EN1176	APPROX. PRICE
Fun Centers™ Design #5	FC02-708	27' 5" x 29' 0" (8,36m x 8,84m)	15' 5" x 17' 0" x 11' 8" (4,7m x 5,18m x 3,56m)	4' 0" (1,22m)	9	19	17	1372 lbs (623 kg)	•	•	•	+	+	\$19,177
Fun Centers™ Design #1	FC02-700	22' 2" x 21' 1" (6,76m x 6,43m)	10' 2" x 9' 1" x 10' 4" (3,1m x 2,77m x 3,15m)	3' 0" (0,91m)	4	8	8	695 lbs (316 kg)	•	•	•	+	+	\$9,926
Fun Centers™ Design #2	FC02-702	22' 2" x 22' 5" (6,76m x 6,83m)	10' 2" x 10' 5" x 10' 4" (3,1m x 3,18m x 3,15m)	3' 0" (0,91m)	4	8	11	756 lbs (343 kg)	•	•	•	+	+	\$12,672



Fun Centers™ Design #7  
FC02-712 • AGES: 2-5



Fun Centers™ Design #3  
FC02-704 • AGES: 2-5



Fun Centers™ Design #4  
FC02-706 • AGES: 2-5

PRODUCT	ITEM	SPACE REQUIRED	SIZE	FALL HEIGHT	EVENTS	USERS	INSTALL HOURS	WEIGHT	ADA	ASTM F1487	CPSC PUB.325	CAN./CSA Z614	EN1176	APPROX. PRICE
Fun Centers™ Design #7	FC02-712	29' 5" x 36' 10" (8,97m x 11,23m)	17' 5" x 24' 10" x 11' 8" (5,31m x 7,57m x 3,56m)	4' 0" (1,22m)	11	24	25	1997 lbs (906 kg)	•	•	•	+	+	\$30,749
Fun Centers™ Design #4	FC02-706	25' 5" x 26' 0" (7,75m x 7,92m)	13' 5" x 14' 0" x 11' 8" (4,09m x 4,27m x 3,56m)	4' 0" (1,22m)	4	11	11	1001 lbs (454 kg)	•	•	•	+	+	\$17,820
Fun Centers™ Design #3	FC02-704	22' 4" x 26' 0" (6,81m x 7,92m)	10' 4" x 14' 0" x 11' 8" (3,15m x 4,27m x 3,56m)	4' 0" (1,22m)	4	11	11	866 lbs (393 kg)	•	•	•	+	+	\$14,782

All playgrounds shown are surface mount and are available in two versions depending on surfacing depth. Additional ground level components may be required for ADA and ASTM compliance.





### Climbing Squares Cliffs

QB-1606 • AGES: 2-12 • SPACE REQUIRED: 19' 0" X 20' 0"

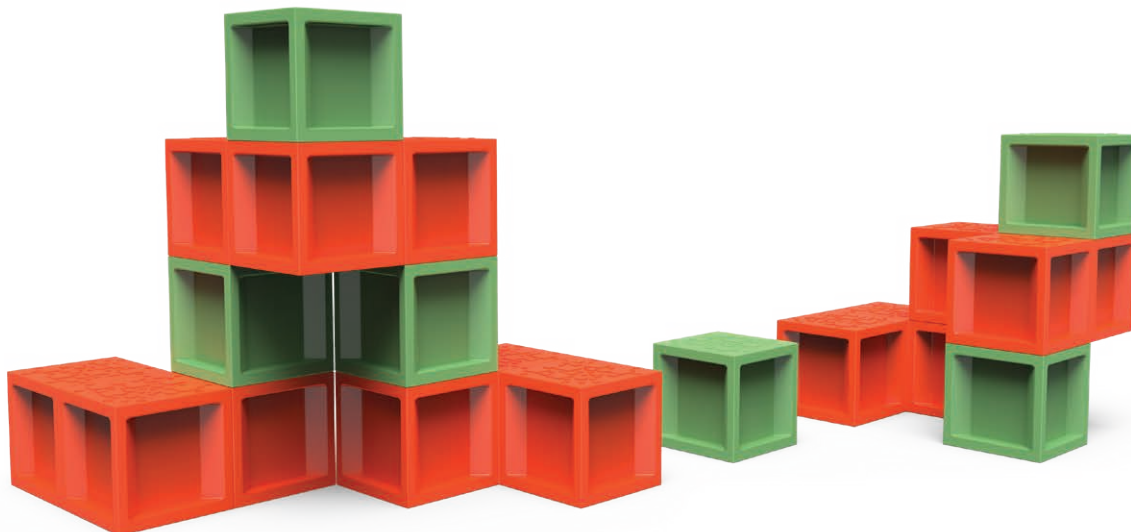

### Climbing Squares Hillocks

QB-1602 • AGES: 2-12 • SPACE REQUIRED: 21' 0" X 17' 0"



### Climbing Squares Knobs

QB-1608 • AGES: 2-12

SPACE REQUIRED: 20' 0" X 19' 0"

PRODUCT	ITEM	SPACE REQUIRED	SIZE	FALL HEIGHT	EVENTS	USERS	INSTALL HOURS	WEIGHT	ADA	ASTM F1487	CPSC PUB.935	ENY/CSA Z614	EN1176	APPROX. PRICE
Climbing Squares Cliffs	QB-1606	18' 0" x 21' 0" (5,49m x 6,4m)	6' 0" x 9' 0" x 4' 0" (1,83m x 2,74m x 1,22m)	4' 0" (1,22m)	3	7	10.33	241 lbs (110 kg)	•	•	•	•	•	\$4,279
Climbing Squares Hillocks	QB-1602	21' 0" x 18' 0" (6,4m x 5,49m)	9' 0" x 6' 0" x 3' 0" (2,74m x 1,83m x 0,91m)	3' 0" (0,91m)	4	10	12.33	316 lbs (143 kg)	•	•	•	•	•	\$5,750
Climbing Squares Knobs	QB-1608	20' 0" x 18' 0" (6,1m x 5,49m)	8' 0" x 6' 0" x 3' 0" (2,44m x 1,83m x 0,91m)	3' 0" (0,91m)	4	7	11.33	253 lbs (115 kg)	•	•	•	•	•	\$4,484



**Branch Out® Gateway**

500-1929 • AGES: 2-5 • SPACE REQUIRED: 23' 6" X 25' 8"

For more Branch Out™ see pages 70-73.



**infiNET™ INET-1700**

INET-1700 • AGES: 2-12 • SPACE REQUIRED: 21' 5" X 21' 3"

For more infiNET™ see pages 62-65.



**PlayCubes® 1.0**

PLAYCUBES-1 • AGES: 2-12 • SPACE REQUIRED: 16' 4" X 16' 11"

For more PlayCubes™ see pages 54-59.



PRODUCT	ITEM	SPACE REQUIRED	SIZE	FALL HEIGHT	EVENTS	USERS	INSTALL HOURS	WEIGHT	ADA	ASTM F1487	CPSC PUB. 325	CAN/CSA Z614	EN1176	APPROX. PRICE
Branch Out® Gateway	500-1929	23' 6" x 25' 8" (7,16m x 7,82m)	13' 7" x 11' 5" x 13' 3" (4,14m x 3,48m x 4,04m)	4' 0" (1,22m)	2	9	22	1272 lbs (577 kg)	•	•	•	•	•	\$18,500
infiNET™ INET-1700	INET-1700	21' 5" x 21' 3" (6,53m x 6,48m)	9' 5" x 9' 3" x 1' 9" (2,87m x 2,82m x 0,53m)	1' 9" (0,53m)	4	8	10	608 lbs (276 kg)	•	•	•	•	•	\$12,000
PlayCubes® 1.0	PLAYCUBES-1	16' 4" x 16' 11" (4,98m x 5,16m)	4' 4" x 4' 11" x 4' 1" (1,32m x 1,5m x 1,24m)	4' 1" (1,24m)	1	4	2	153 lbs (70 kg)	•	•	•	•	•	\$3,725

+CSA and EN compliant versions available.

All play equipment must be installed over an appropriate impact absorbing surface that complies with ASTM or CSA standards. See your Playworld representative for more information.



### ModPods™ MOD-198

MOD-198 • AGES: 2-5 • SPACE REQUIRED: 39' 10" X 24' 0"



### ModPods™ MOD-181

MOD-181 • AGES: 2-5 • SPACE REQUIRED: 25' 5" X 20' 0"

For more ModPods™ see pages 144, 176

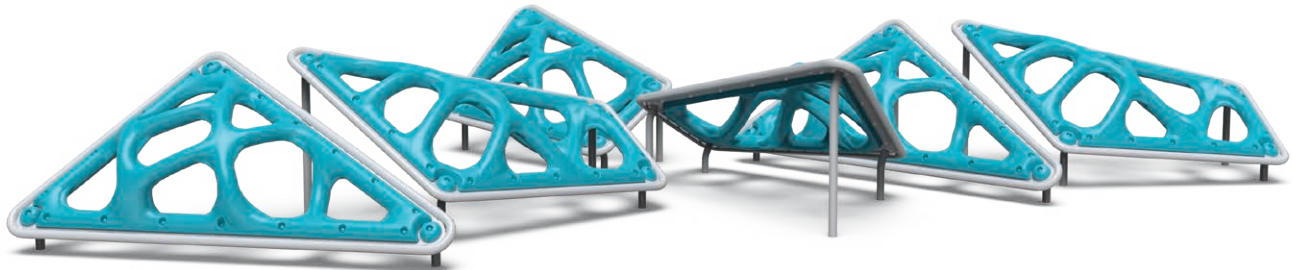

### ModPods™ MOD-192

MOD-192 • AGES: 2-5 • SPACE REQUIRED: 39' 6" X 34' 4"

PRODUCT	ITEM	SPACE REQUIRED	SIZE	FALL HEIGHT	EVENTS	USERS	INSTALL HOURS	WEIGHT	ADA	ASTM F1487	CPSC PUB.925	ICC/CSA 2814	EN1176	APPROX. PRICE
ModPods™ MOD-198	MOD-198	39' 10" x 24' 0" (12,14m x 7,32m)	27' 8" x 11' 11" x 4' 0" (8,43m x 3,63m x 1,22m)	4' 0" (1,22m)	8	18	14	1284 lbs (583 kg)	•	•	•	•	•	\$16,556
ModPods™ MOD-181	MOD-181	25' 5" x 20' 0" (7,75m x 6,1m)	14' 2" x 7' 2" x 4' 0" (4,32m x 2,19m x 1,22m)	4' 0" (1,22m)	2	7	7	583 lbs (264 kg)	•	•	•	•	•	\$7,008
ModPods™ MOD-192	MOD-192	39' 6" x 34' 4" (12,04m x 10,46m)	27' 4" x 22' 2" x 4' 0" (8,33m x 6,76m x 1,22m)	4' 0" (1,22m)	6	22	20	1810 lbs (821 kg)	•	•	•	•	•	\$21,094

All playgrounds shown are in-ground mount and available as surface mount. Additional ground level components may be required for ADA and ASTM compliance.

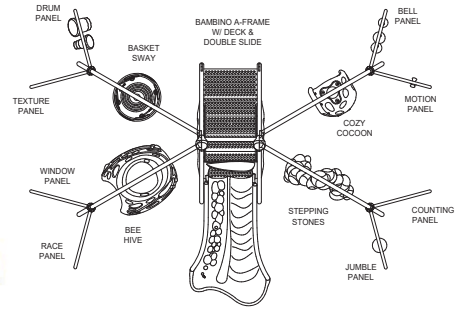

### Bambino Playville

ACT-1300 • AGES: 2-5 • SPACE REQUIRED: 40' 1" X 32' 7"

TOP INCLUSIVE PRODUCT

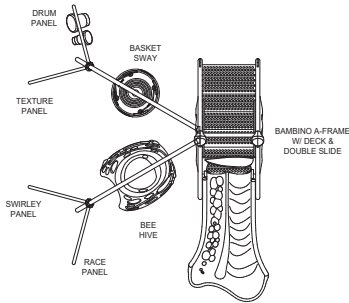

### Bambino Kiddie Corner

ACT-1302 • AGES: 2-5 • SPACE REQUIRED: 28' 9" X 32' 7"



PRODUCT	ITEM	SPACE REQUIRED	SIZE	FALL HEIGHT	EVENTS	USERS	INSTALL HOURS	WEIGHT	ADA	ASTM F1487	CPSC PUB. 325	CAN/CSA Z614	EN1176	APPROX. PRICE
Bambino Playville	ACT-1300	40' 1" x 32' 7" (12,22m x 9,93m)	20' 7" x 27' 11" x 11' 2" (6,27m x 8,51m x 3,4m)	4' 0" (1,22m)	15	32	32	2356 lbs (1069 kg)	•	•	•	+	•	\$42,500
Bambino Kiddie Corner	ACT-1302	28' 9" x 32' 7" (8,76m x 9,93m)	16' 8" x 20' 7" x 11' 2" (5,08m x 6,27m x 3,4m)	4' 0" (1,22m)	9	19	21	1696 lbs (769 kg)	•	•	•	+	+	\$29,000

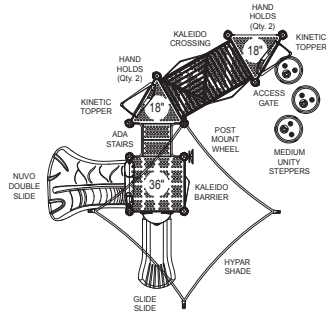

### Playmakers® Cooper's Corner

500-2030 • AGES: 2-12 • SPACE REQUIRED: 32' 0" X 31' 0"

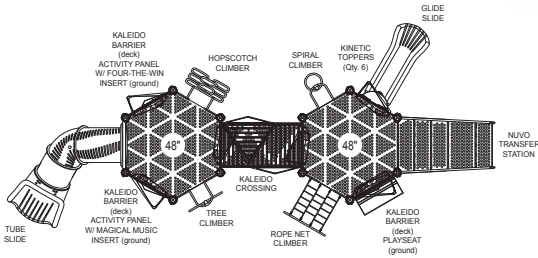

### Playmakers® Raelyn's Oasis

500-2032 • AGES: 2-12 • SPACE REQUIRED: 47' 10" X 27' 8"



PRODUCT	ITEM	SPACE REQUIRED	SIZE	FALL HEIGHT	EVENTS	USERS	INSTALL HOURS	WEIGHT	ADA	ASTM F1487	CPSI PUB. 325	CAN./CSA Z614	EN1176	APPROX. PRICE
Playmakers® Cooper's Corner	500-2030	32' 0" x 31' 0" (9,75m x 9,45m)	19' 11" x 18' 10" x 13' 6" (6,07m x 5,74m x 4,11m)	3' 0" (0,91m)	7	20	34	2379 lbs (1079 kg)	•	•	•	+	+	\$41,000
Playmakers® Raelyn's Oasis	500-2032	47' 10" x 27' 8" (14,58m x 8,43m)	35' 7" x 15' 6" x 14' 11" (10,84m x 4,72m x 4,55m)	4' 0" (1,22m)	11	41	58	3902 lbs (1770 kg)	•	•	•	+	+	\$64,500

All playgrounds shown are in-ground mount and available as surface mount. Additional ground level components may be required for ADA and ASTM compliance.

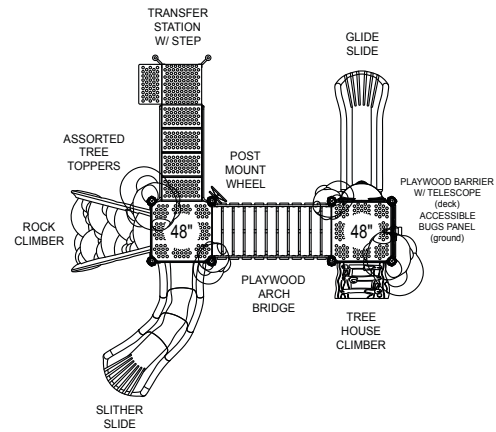

### Challengers® Timber Grove

350-2224 • AGES: 2-5 • SPACE REQUIRED: 28' 8" X 29' 4"

PRODUCT	ITEM	SPACE REQUIRED	SIZE	FALL HEIGHT	EVENTS	USERS	INSTALL HOURS	WEIGHT	ADA	ASTM F1487	CPSC PUB. 325	CAN/CSA Z614	EN1176	APPROX. PRICE
Challengers® Timber Grove	350-2224	28' 8" x 29' 4" (8,74m x 8,94m)	17' 7" x 17' 1" x 13' 2" (5,36m x 5,21m x 4,01m)	4' 0" (1,22m)	8	25	28	1770 lbs (803 kg)	•	•	•			\$28,500

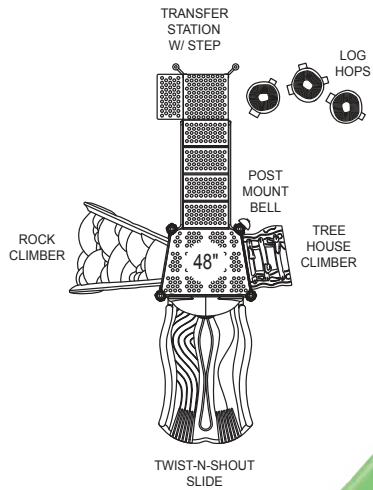

### Challengers® Log Slide

350-2220 • AGES: 2-5 • SPACE REQUIRED: 25' 6" X 29' 0"

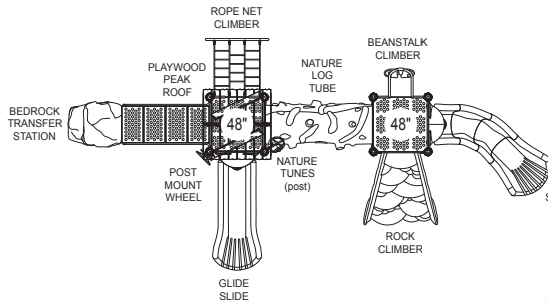

### Challengers® Natural Nook

350-2025 • AGES: 2-5 • SPACE REQUIRED: 38' 8" X 25' 0"

PRODUCT	ITEM	SPACE REQUIRED	SIZE	FALL HEIGHT	EVENTS	USERS	INSTALL HOURS	WEIGHT	ADA	ASTM F1487	CPSC PUB. 325	CAN./CSA Z614	EN1176	APPROX. PRICE
Challengers® Log Slide	350-2220	25' 6" x 29' 0" (7,77m x 8,84m)	13' 1" x 16' 10" x 8' 6" (3,99m x 5,13m x 2,59m)	4' 0" (1,22m)	7	20	19	1105 lbs (502 kg)	•	•	•	+		\$15,500
Challengers® Natural Nook	350-2025	38' 8" x 25' 0" (11,79m x 7,62m)	26' 6" x 12' 9" x 12' 1" (8,08m x 3,89m x 3,68m)	4' 0" (1,22m)	9	25	26	2364 lbs (1073 kg)	•	•	•	+	+	\$35,000

All playgrounds shown are in-ground mount and available as surface mount. Additional ground level components may be required for ADA and ASTM compliance.



Playground above has custom features. For more information, contact your local sales representative.

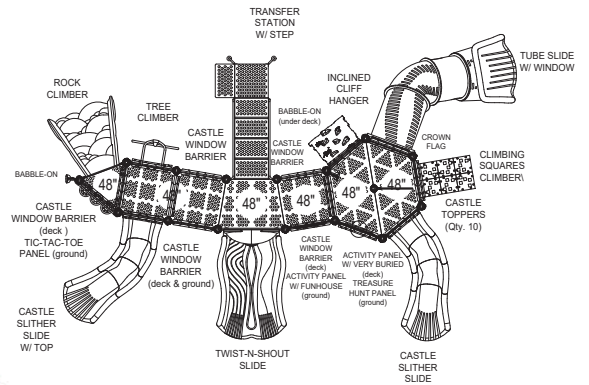

### Challengers® Zelda's Fortress

350-1928 • AGES: 2-5 • SPACE REQUIRED: 40' 0" X 60' 6"

PRODUCT	ITEM	SPACE REQUIRED	SIZE	FALL HEIGHT	EVENTS	USERS	INSTALL HOURS	WEIGHT	ADA	ASTM F1487	CPSC PUB. 325	CAV/ CSA Z614	EN1176	APPROX. PRICE
Challengers® Zelda's Fortress	350-1928	40' 0" x 60' 6" (12,19m x 18,44m)	27' 10" x 18' 2" x 14' 10" (8,48m x 5,54m x 4,52m)	4' 0" (1,22m)	14	54	67	3439 lbs (1560 kg)	•	•	•	+	+	\$68,000

+CSA and EN compliant versions available.

All play equipment must be installed over an appropriate impact absorbing surface that complies with ASTM or CSA standards. See your Playworld representative for more information.





PlaySoTeil

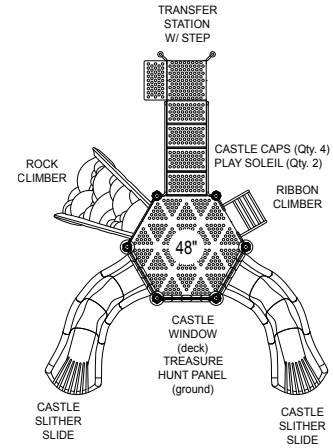

### Challengers® Scavenger's Castle

350-2320 • AGES: 2-5 • SPACE REQUIRED: 26' 6" X 29' 6"

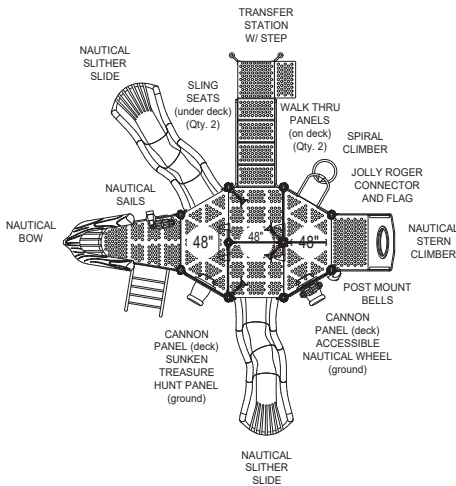

### Challengers® Jolly Roger

350-1824 • AGES: 2-5 • SPACE REQUIRED: 30' 4" X 33' 0"

PRODUCT	ITEM	SPACE REQUIRED	SIZE	FALL HEIGHT	EVENTS	USERS	INSTALL HOURS	WEIGHT	ADA	ASTM F1487	CPSC PUB. 329	CAN./CSA Z614	EN1176	APPROX. PRICE
Challengers® Scavenger's Castle	350-2320	26' 6" x 29' 6" (8,08m x 8,99m)	14' 4" x 17' 5" x 11' 5" (4,37m x 5,31m x 3,48m)	4' 0" (1,22m)	5	23	24	1283 lbs (582 kg)	•	•	•	+		\$22,500
Challengers® Jolly Roger	350-1824	30' 4" x 33' 0" (9,24m x 10,06m)	18' 0" x 20' 9" x 21' 1" (5,49m x 6,32m x 6,43m)	4' 0" (1,22m)	15	47	47	2324 lbs (1054 kg)	•	•	•	+	+	\$44,000

All playgrounds shown are in-ground mount and available as surface mount. Additional ground level components may be required for ADA and ASTM compliance.

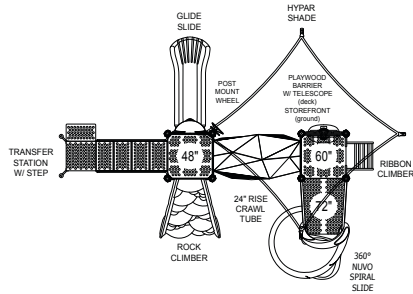

### Challengers® School Yard Junction w/ Shade

350-2223 • AGES: 2-12 • SPACE REQUIRED: 33' 6" X 28' 10"

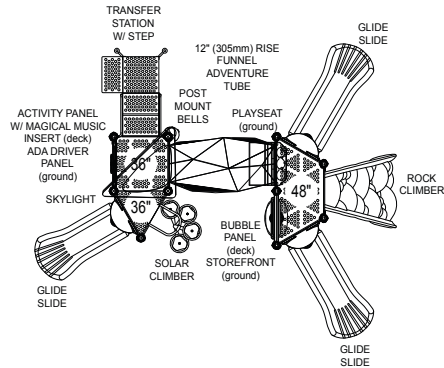

### Challengers® Triplex

350-2226 • AGES: 2-5 • SPACE REQUIRED: 32' 2" X 28' 5"



### Challengers® Northern Lights

350-2227 • AGES: 2-5 • SPACE REQUIRED: 32' 8" X 28' 6"

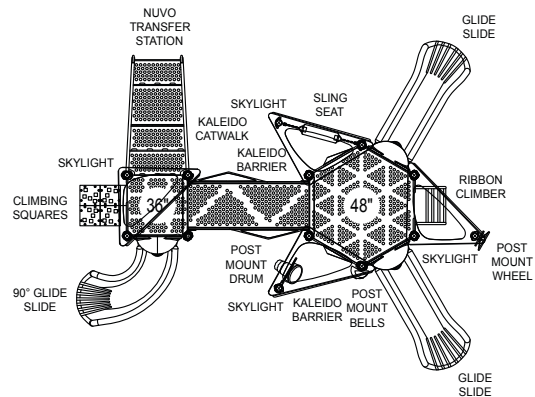

PRODUCT	ITEM	SPACE REQUIRED	SIZE	FALL HEIGHT	EVENTS	USERS	INSTALL HOURS	WEIGHT	ADA	ASTM F1487	CPSI PUB.325	CAN/CSA Z614	EN1176	APPROX. PRICE
Challengers® Schoolyard Junction w/ Shade	350-2223	33' 6" x 28' 10" (10,21m x 8,79m)	23' 4" x 16' 11" x 16' 6" (7,11m x 5,16m x 5,03m)	6' 0" (1,83m)	8	28	32	2185 lbs (991 kg)	•	•	•	+		\$33,000
Challengers® Triplex	350-2226	32' 2" x 28' 5" (9,81m x 8,66m)	20' 0" x 16' 3" x 13' 8" (6,1m x 4,95m x 4,17m)	4' 0" (1,22m)	12	37	32	1793 lbs (814 kg)	•	•	•	+		\$31,500
Challengers® Northern Lights	350-2227	32' 8" x 28' 6" (9,96m x 8,69m)	20' 5" x 16' 3" x 12' 8" (6,22m x 4,95m x 3,86m)	4' 0" (1,22m)	11	29	36	2725 lbs (1236 kg)	•	•	•	+		\$39,000

+CSA and EN compliant versions available.

All play equipment must be installed over an appropriate impact absorbing surface that complies with ASTM or CSA standards. See your Playworld representative for more information.

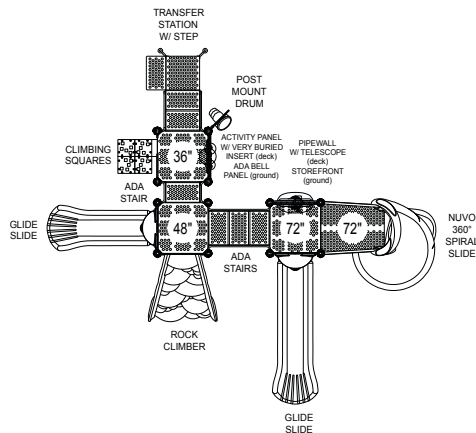

### Challengers® Geo Mountain

350-2164 • AGES: 2-12 • SPACE REQUIRED: 35' 6" X 33' 4"

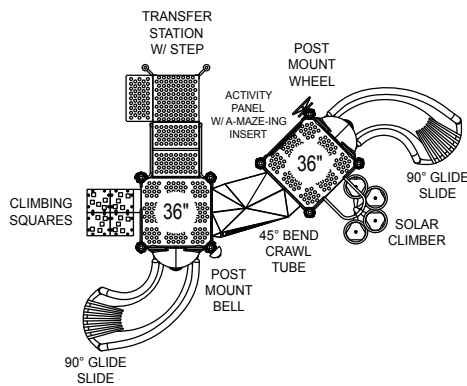

### Challengers® Tot Lot

350-2221 • AGES: 2-5 • SPACE REQUIRED: 28' 6" X 24' 6"

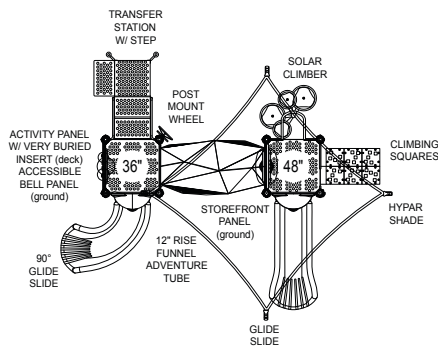

### Challengers® Step & Slide

350-2225 • AGES: 2-5 • SPACE REQUIRED: 30' 0" X 26' 8"

PRODUCT	ITEM	SPACE REQUIRED	SIZE	FALL HEIGHT	EVENTS	USERS	INSTALL HOURS	WEIGHT	ADA	ASTM F1487	CPSC PUB.325	CAN/CSA Z614	EN1176	APPROX. PRICE
Challengers® Geo Mountain	350-2164	35' 6" x 33' 4" (10,82m x 10,16m)	23' 0" x 21' 0" x 10' 6" (7,01m x 6,4m x 3,2m)	6' 0" (1,83m)	10	33	41	2421 lbs (1098 kg)	•	•	•	•	•	\$34,500
Challengers® Tot Lot	350-2221	28' 6" x 24' 6" (8,69m x 7,47m)	16' 4" x 12' 4" x 8' 5" (4,98m x 3,76m x 2,57m)	3' 0" (0,91m)	8	23	26	1154 lbs (523 kg)	•	•	•	•	•	\$19,500
Challengers® Step & Slide	350-2225	30' 0" x 26' 8" (9,14m x 8,13m)	18' 6" x 15' 0" x 14' 6" (5,64m x 4,57m x 4,42m)	4' 0" (1,22m)	9	29	32	1582 lbs (718 kg)	•	•	•	•	•	\$30,500



Campground

IDEA-1800



Challengers® Lilah's Lookout

350-1962



Challengers® Tic-Tac-Go!

350-2020



Challengers® Diana's Dreamland

350-2122



Challengers® Fort Twist

350-1923



Challengers® Slide Shuffle

350-2165

PRODUCT	ITEM	SPACE REQUIRED	SIZE	FALL HEIGHT	EVENTS	USERS	INSTALL HOURS	WEIGHT	ADA	ASTM F1487	CPSC PUB.325	CAN/CSA Z614	EN1176	APPROX. PRICE
Campground	IDEA-1800	28' 0" x 41' 6" (8,53m x 12,65m)	29' 1" x 15' 8" x 4' 1" (8,86m x 4,78m x 1,24m)	4' 1" (1,24m)	19	33	33	5158 lbs (2339 kg)	•	•	•	•	•	\$35,500
Challengers® Lilah's Lookout	350-1962	29' 2" x 28' 10" (8,89m x 8,79m)	17' 1" x 16' 8" x 8' 6" (5,21m x 5,08m x 2,59m)	4' 0" (1,22m)	8	25	25	1393 lbs (632 kg)	•	•	•	+	+	\$21,500
Challengers® Tic-Tac-Go!	350-2020	28' 4" x 25' 6" (8,63m x 7,77m)	16' 1" x 13' 3" x 8' 6" (4,9m x 4,04m x 2,59m)	4' 0" (1,22m)	7	22	25	1173 lbs (532 kg)	•	•	•	+	+	\$18,500
Challengers® Diana's Dreamland	350-2122	30' 4" x 31' 8" (9,24m x 9,65m)	18' 3" x 19' 7" x 8' 6" (5,56m x 5,97m x 2,59m)	4' 0" (1,22m)	10	27	31	1574 lbs (714 kg)	•	•	•	+	+	\$28,000
Challengers® Fort Twist	350-1923	38' 0" x 28' 0" (11,58m x 8,53m)	25' 7" x 15' 10" x 9' 5" (7,8m x 4,82m x 2,87m)	4' 0" (1,22m)	13	37	41	1943 lbs (881 kg)	•	•	•	+	+	\$33,500
Challengers® Slide Shuffle	350-2165	26' 10" x 27' 8" (8,18m x 8,43m)	14' 8" x 15' 6" x 7' 6" (4,47m x 4,72m x 2,29m)	3' 0" (0,91m)	7	20	21	1092 lbs (495 kg)	•	•	•	+		\$16,500

+CSA and EN compliant versions available.

All play equipment must be installed over an appropriate impact absorbing surface that complies with ASTM or CSA standards. See your Playworld representative for more information.



### PlaySimple® Mega Fun Station

PSD-1108-FTD



### PlaySimple® Mighty Fun Mountain

PSD-1101-FTD

PlaySimple color palettes:



### PlaySimple® Simply Play

PSD-1107-FTD



### PlaySimple® Tunnel Junction

PSD-1102-FTD

PRODUCT	ITEM	SPACE REQUIRED	SIZE	FALL HEIGHT	EVENTS	USERS	INSTALL HOURS	WEIGHT	ADA	ASTM F1487	CPSC PUB.325	CAN/CSA Z614	EN1176	APPROX. PRICE
PlaySimple® Mega Fun Station	PSD-1108-FTD	30' 10" x 33' 0" (9,4m x 10,06m)	18' 10" x 20' 11" x 11' 0" (5,74m x 6,38m x 3,35m)	4' 0" (1,22m)	11	28	31	2055 lbs (932 kg)	•	•	•	+	•	\$21,668
PlaySimple® Mighty Fun Mountain	PSD-1101-FTD	27' 4" x 19' 9" (8,33m x 6,02m)	15' 4" x 7' 9" x 11' 0" (4,67m x 2,36m x 3,35m)	4' 0" (1,22m)	4	10	10	931 lbs (423 kg)	•	•	•	+	•	\$8,780
PlaySimple® Simply Play	PSD-1107-FTD	22' 2" x 20' 3" (6,76m x 6,17m)	10' 2" x 8' 3" x 10' 0" (3,1m x 2,51m x 3,05m)	3' 0" (0,91m)	4	10	10	757 lbs (343 kg)	•	•	•	+	•	\$8,119
PlaySimple® Tunnel Junction	PSD-1102-FTD	28' 1" x 26' 10" (8,56m x 8,18m)	16' 1" x 14' 10" x 11' 0" (4,9m x 4,52m x 3,35m)	4' 0" (1,22m)	8	19	18	1480 lbs (672 kg)	•	•	•	+	•	\$15,488





## Freestanding

A great playground isn't measured by a single structure alone, but by the entire space around it. Our freestanding products add extra flair (and fun) for everyone.

- 118 **NEOS<sup>®</sup>**
- 120 **Concerto<sup>™</sup>**
- 122 **Motion Play**
- 132 **Swings**
- 134 **Slides**
- 135 **Tubes**
- 136 **Balance & Sports Activities**
- 138 **Pretend Play**
- 140 **Climbers**
- 150 **Boulders**
- 152 **Nature-Inspired**
- 153 **Dinosaurs**
- 154 **Sculpted Play Elements**



### NEOS® 360 Accessible

ZZXX0994 • ALL AGES

Awarded for its innovation, NEOS 360 encompasses the best of physical endurance in a full-body gaming approach that helps participants develop agility, coordination, strength, and stamina. Its circular design develops peripheral vision, auditory, and spatial awareness skills.

- 8 games
- 1- and 2-player options or team play
- 8 buttons
- Games are approximately 45 seconds each
- Free instructional sign included
- Original NEOS® 360 (ZZXX0995) also available

**TOP INCLUSIVE PRODUCT**

PRODUCT	ITEM	SPACE REQUIRED	FALL HEIGHT	USERS	INSTALL HOURS	WEIGHT	AIA	ASTM F1487	CPSC PUB.325	CAN/CSA Z614	EN1176	APPROX. PRICE
NEOS® 360 Accessible	ZZXX0994	15' 0" x 12' 0" (4,57m x 3,66m)	()	6	5	814 lbs (369 kg)	•	•	•	•	•	\$39,875
NEOS® 360 Original (Not Shown)	ZZXX0995	15' 0" x 12' 0" (4,57m x 3,66m)	()	6	5	814 lbs (369 kg)	•	•	•	•	•	\$40,069





## NEOS® Arc

ZZXX0997 • ALL AGES

Looking to make the most of a limited space or small budget? The NEOS Arc is a sleek, economical, small-footprint version of the NEOS 360. Now anyone can bring electronic play to the playground! With the same great games, the NEOS Arc keeps kids jumping and darting between the four pillars—building strength and stamina.

- 8 games
- 1- and 2-player options
- Games last from 45-60 seconds
- 8 buttons on 4 towers
- Free instructional sign included
- Optional custom back panel available



## NEOS® Wall

ZZXX1000 • ALL AGES

Players race between four towers, developing agility, coordination, strength, and stamina in a healthy, competitive environment.

Nine different games and three skill levels provide players with electrifying challenges. NEOS Wall's steel towers are clad with thick, rotomolded plastic, available in any color.

- 9 games
- 1- and 2-player options
- Games last from 45-60 seconds
- 16 buttons on 4 towers
- Free instructional sign included
- Optional custom back panel available

PRODUCT	ITEM	SPACE REQUIRED	FALL HEIGHT	USERS	INSTALL HOURS	WEIGHT	ADA	ASTM F1487	CPSC PUB.325	CAW/CSA Z614	EN1176	APPROX. PRICE
NEOS® Arc	ZZXX0997	20' 0" x 14' 0" (6,1m x 4,27m)	()	6	4	609 lbs (276 kg)	•	•	•	•	•	\$36,979
NEOS® Wall	ZZXX1000	20' 0" x 14' 0" (6,1m x 4,27m)	()	4	2	1408 lbs (639 kg)	•	•	•	•	•	\$61,939



The Concerto line of outdoor musical equipment lets children of all abilities experience the joy and benefits of making music. Set at an accessible angle and height, these colorful instruments will encourage kids to band together and jam out! Concerto also makes a wonderful addition to any inclusive playground!

TOP INCLUSIVE PRODUCT



### Chimes

ZZXX0667 • AGES: 2-12

- Eight aluminum chimes tuned to the traditional music scale
- Concave design for accessibility
- Rubber mallets attached to frame



### Vibes

ZZXX0666 • AGES: 2-12

- Fourteen chimes tuned to the seven-note scale
- Gives off a full, sustained note when struck
- Rubber mallets attached to frame

PRODUCT	ITEM	SPACE REQUIRED	FALL HEIGHT	USERS	INSTALL HOURS	WEIGHT	ADA	ASTM F1487	CPSC PUB. 225	CAV/CSA Z614	EN1176	APPROX. PRICE
Concerto™ Vibes	ZZXX0666	-	-	1	2	135 lbs (62 kg)	•	•		•	•	\$5,377
Concerto™ Chimes	ZZXX0667	-	-	1	2	130 lbs (59 kg)	•	•		•	•	\$5,391

+CSA and EN compliant versions available.

All play equipment must be installed over an appropriate impact absorbing surface that complies with ASTM or CSA standards. See your Playworld representative for more information.



### Congas AGES: 2-12

- Varying size and color drum heads produce unique tones
- Set at an angle for accessibility



Two Congas • ZZXX0663

Three Congas • ZZXX0664

Five Congas • ZZXX0665



### Cabasa AGES: 2-12

- Produces metallic rattling sound when spun back and forth
- Arched frame for accessibility



Small Cabasa • ZZXX0660



Medium Cabasa • ZZXX0661



Large Cabasa • ZZXX0662

PRODUCT	ITEM	SPACE REQUIRED	FALL HEIGHT	USERS	INSTALL HOURS	WEIGHT	ADA	ASTM F1487	CPSC PUB.325	CAN./CSA Z614	EN1176	APPROX. PRICE
Concerto™ Two Congas	ZZXX0663	–	–	1	1	51 lbs (24 kg)	•	•	•	•	•	\$1,953
Concerto™ Three Congas	ZZXX0664	–	–	1	1	62 lbs (28 kg)	•	•	•	•	•	\$2,629
Concerto™ Five Congas	ZZXX0665	–	–	1	1	79 lbs (36 kg)	•	•	•	•	•	\$3,998
Concerto™ Small Cabasa	ZZXX0660	–	–	1	2	60 lbs (28 kg)	•	•	•	•	•	\$1,067
Concerto™ Medium Cabasa	ZZXX0661	–	–	1	2	68 lbs (31 kg)	•	•	•	•	•	\$1,195
Concerto™ Large Cabasa	ZZXX0662	–	–	1	2	79 lbs (36 kg)	•	•	•	•	•	\$1,334



### Accessible Whirl

ZZXX1158 • AGES: 2-12

- 6' (1,83m) diameter classic whirl sits flush with the ground
- Accommodates up to two wheelchair users, plus other riders
- Added seat gives extra support for kids or caregivers

TOP INCLUSIVE PRODUCT



### Unity® SpinR 2 Seats

ZZXX0349 • AGES: 5-12

- Whirl with angled sides delivers a unique sensation and physically active experience—climb, spin, stand, sit, lie, hang, or balance
- Optional 1 or 2 recessed, outward-facing inclusive seats at transfer height with an inward pitch to support children with poor trunk control
- Accommodates up to 10 kids—encouraging cooperation and socialization

TOP INCLUSIVE PRODUCT

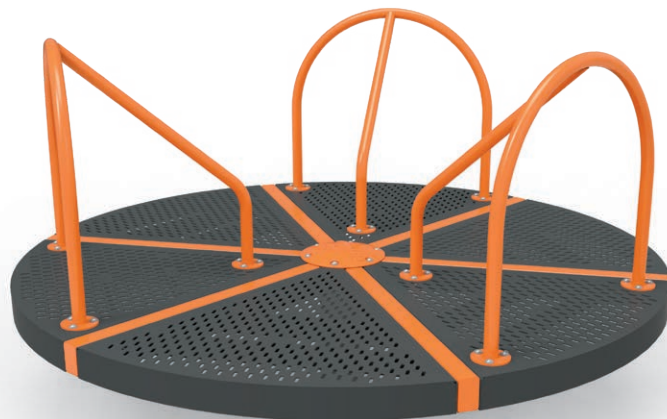

### Whirl-a-Round

ZZXX1153 • AGES: 5-12

- Classic whirl design offers familiar spinning experience—promoting vestibular, proprioceptive, balance, and cooperative skills
- 6' (1,83m) diameter accommodates many kids in a small footprint
- EN version available, ZZXX1154

PRODUCT	ITEM	SPACE REQUIRED	FALL HEIGHT	USERS	INSTALL HOURS	WEIGHT	ADA	ASTM F1487	CPSC PUB.325	CAV/CSA Z614	EN1176	APPROX. PRICE
Accessible Whirl	ZZXX1158	24' 8" x 24' 8" (7,52m x 7,52m)	1' 3" (0,38m)	9	10	995 lbs (451 kg)	•	•	•	•	•	\$14,371
Unity® SpinR 2 Seats	ZZXX0349	25' 8" x 25' 8" (7,82m x 7,82m)	1' 5" (0,44m)	10	5	870 lbs (395 kg)	•	•	•	•	•	\$14,319
Whirl-a-Round	ZZXX1153	23' 11" x 23' 11" (7,29m x 7,29m)	1' 5" (0,43m)	12	3	441 lbs (200 kg)	•	•	•	•	•	\$5,919
Whirl-a-Round (EN)	ZZXX1154	23' 11" x 23' 11" (7,29m x 7,29m)	1' 5" (0,43m)	12	4	524 lbs (238 kg)	•	•	•	•	•	\$8,115

+CSA and EN compliant versions available.

All play equipment must be installed over an appropriate impact absorbing surface that complies with ASTM or CSA standards. See your Playworld representative for more information.

## Cone Spinners

Cone Spinners combine the excitement of spinning with the challenge of climbing for an exhilarating play experience! Cone Spinners let many children play at once in an exciting event that combines the thrill of speed and the wonder of height with net play.

### Cone Spinner

ZZXX0912 • AGES: 5-12

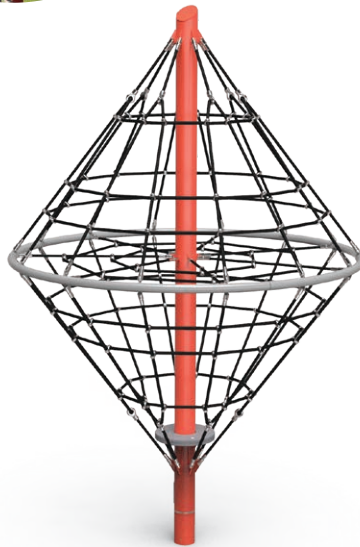
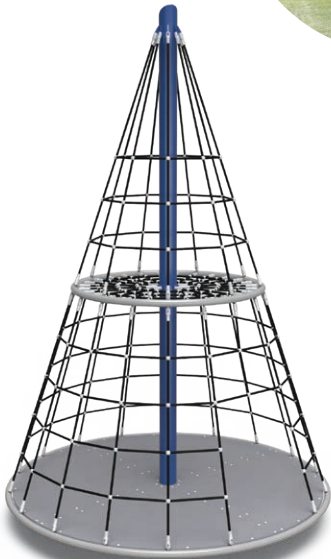
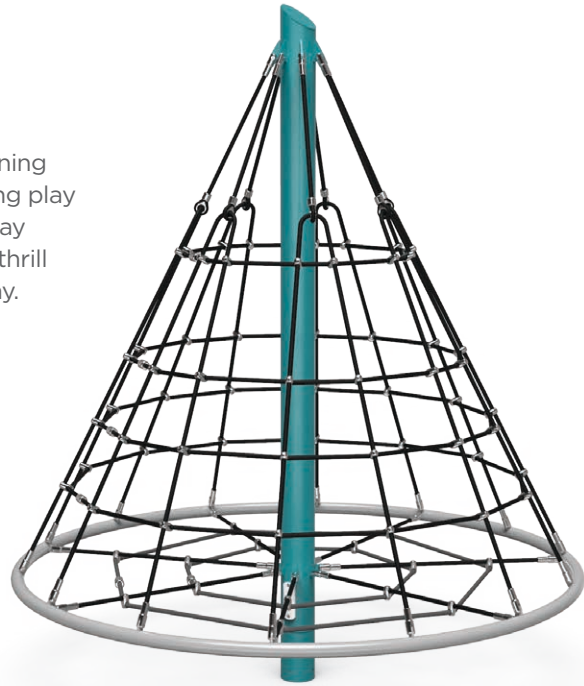

### Cone Spinner Double-Decker

ZZXX0914 • AGES: 5-12

**TOP INCLUSIVE PRODUCT**

### Cone Spinner Diamond

ZZXX0913 • AGES: 5-12

### Cone Spinner w/ Floor

ZZXX0911 • AGES: 5-12

PRODUCT	ITEM	SPACE REQUIRED	FALL HEIGHT	USERS	INSTALL HOURS	WEIGHT	ADA	ASTM F1487	CPSC PUB.325	CAN/CSA Z614	EN1176	APPROX. PRICE
Cone Spinner	ZZXX0912	18' 10" x 18' 10" (5,74m x 5,74m)	5' 2" (1,58m)	7	6	205 lbs (93 kg)	•	•	•	•	•	\$12,152
Cone Spinner Double-Decker	ZZXX0914	19' 10" x 19' 10" (6,04m x 6,04m)	9' 4" (2,83m)	14	10	522 lbs (237 kg)	•	•	•	•	•	\$21,009
Cone Spinner Diamond	ZZXX0913	18' 10" x 18' 10" (5,74m x 5,74m)	8' 6" (2,59m)	12	8	259 lbs (118 kg)	•	•	•	•	•	\$15,837
Cone Spinner w/ Floor	ZZXX0911	18' 10" x 18' 10" (5,74m x 5,74m)	5' 0" (1,52m)	7	9	367 lbs (167 kg)	•	•	•	•	•	\$14,641



### Spinami

ZZXX0151 • AGES: 5-12

- Upright spinning whirl accommodates lots of kids at once
- The closer you stand to the center pole, the faster Spinami will spin!



### Overdrive

ZZXX0150 • AGES: 5-12

- Kids hold onto the handles, run to start the motion, and get dizzy with excitement
- Exciting overhead whirl can accommodate a large group of kids
- The more kids run, the faster Overdrive spins!



### Revo

ZZXX0081 • AGES: 5-12

- Vertical rotating ring makes Revo a unique play experience
- Sitting inside, a child can spin a full 360° or rock back and forth
- Designed with outer grips so other children can assist with spinning



### Vortex

350-VORTEX • AGES: 5-12

- Fun comes full circle while kids stand and spin for a vigorous ride



PRODUCT	ITEM	SPACE REQUIRED	FALL HEIGHT	USERS	INSTALL HOURS	WEIGHT	ADA	ASTM F1487	CPSC PUB.325	CAN/CSA Z914	EN1176	APPROX. PRICE
Spinami	ZZXX0151	24' 0" x 24' 0" (7,32m x 7,32m)	4' 0" (1,22m)	7	6	343 lbs (156 kg)	•	•	•	•	•	\$6,209
Overdrive	ZZXX0150	24' 2" x 24' 2" (7,37m x 7,37m)	5' 6" (1,68m)	6	3	331 lbs (150 kg)	•	•	•	•	•	\$4,715
Revo	ZZXX0081	18' 1" x 13' 5" (5,52m x 4,09m)	1' 5" (0,42m)	2	2	295 lbs (134 kg)	•	•	•	•	•	\$10,369
Vortex	350-VORTEX	28' 7" x 18' 5" (8,71m x 5,61m)	0' 9" (0,23m)	2	4	335 lbs (152 kg)	•	•	•	•	•	\$4,837

+CSA and EN compliant versions available.

All play equipment must be installed over an appropriate impact absorbing surface that complies with ASTM or CSA standards. See your Playworld representative for more information.



### Spintastic

ZZXX0132 • AGES: 5-12

- Kids can sit or stand; designed on a slight angle for maximum spinning
- Self-regulated speed, based on the child's ability and balance



### Swirl Saucer

ZZXX0503 • AGES: 2-12

- Spin and rock in this durable, metal saucer
- Encourages cooperative play or interaction with a caregiver
- Up to 2 children can enjoy the ride

**TOP INCLUSIVE PRODUCT**



### Whirligig

ZZXX0043 • AGES: 5-12

- There will be giggles galore as children delight in wacky whirling action



### Cozy Cocoon™

ZZXX0483 • AGES: 2-12

- Designed for children who need a cozy space to escape to when overstimulated
- The spinning motion and interior tactile experiences assist children in relaxing
- The windows on both sides allow for adult supervision, while the child feels enclosed in the space

**TOP INCLUSIVE PRODUCT**



### Spin Cup

ZZXX0065 • AGES: 2-12

- Kids sit in the cup while others spin them

**TOP INCLUSIVE PRODUCT**



### Spin Central

350-SPIN • AGES: 5-12

- Kids grab hold above and use their upper bodies to make crazy twists and turns



### Loopy Whoop

ZZUN7096 • AGES: 5-12

- Kids start to spin as their body movement determines the speed

PRODUCT	ITEM	SPACE REQUIRED	FALL HEIGHT	USERS	INSTALL HOURS	WEIGHT	ADA	ASTM F1487	CPSC PUB.325	CAN./CSA Z614	EN1176	APPROX. PRICE
Spintastic	ZZXX0132	13' 8" x 13' 8" (4,17m x 4,17m)	0' 5" (0,12m)	2	1	54 lbs (25 kg)	•	•	•	•	•	\$969
Swirl Saucer	ZZXX0503	21' 5" x 21' 5" (6,53m x 6,53m)	2' 1" (0,63m)	4	3	170 lbs (78 kg)	•	•	•	•	•	\$4,489
Whirligig	ZZXX0043	14' 6" x 14' 6" (4,42m x 4,42m)	1' 5" (0,42m)	4	3	149 lbs (68 kg)	•	•	•	•	•	\$2,875
Cozy Cocoon™	ZZXX0483	14' 11" x 14' 9" (4,55m x 4,5m)	1' 2" (0,36m)	3	2	132 lbs (60 kg)	•	•	•	•	•	\$3,795
Spin Cup	ZZXX0065	14' 0" x 14' 0" (4,27m x 4,27m)	2' 0" (0,61m)	1	2	58 lbs (26 kg)	•	•	•	•	•	\$1,045
Spin Central	350-SPIN	16' 4" x 14' 1" (4,98m x 4,29m)	7' 0" (2,13m)	1	2	103 lbs (47 kg)	•	•	•	•	•	\$2,158
Loopy Whoop	ZZUN7096	13' 8" x 13' 8" (4,17m x 4,17m)	1' 2" (0,36m)	3	2	100 lbs (45 kg)	•	•	•	•	•	\$2,795



### Unity® RockR

ZZXX0193 • AGES: 2-12

- Unlike a single rider experience, this spring rider can accommodate six riders at a time
- Multiple ways to engage—sit on outside edge, sit, kneel, or lie in bowl
- Multigenerational
- Inclusive features: mounted at transfer height, provides full body support, and encourages children of all abilities to play together on the same piece of equipment
- Allows child-caregiver interaction



### Wave Rider Seesaw

ZZXX0650 • AGES: 2-12

- Encourages cooperative play
- Unique spring design prevents "bottoming out" for safer play



### Bing Boing

ZZXX0044 • AGES: 5-12

- Kids can bob back and forth and spin around at the same time



### Nucleo

ZZXX0083 • AGES: 5-12

- Kids can bounce and "surf"
- Range of motion is determined by child's weight
- Promotes balance and coordination

PRODUCT	ITEM	SPACE REQUIRED	FALL HEIGHT	USERS	INSTALL HOURS	WEIGHT	ADA	ASTM F1487	CPSC PUB.325	CAV/CSA Z614	EN1176	APPROX. PRICE
Unity® RockR	ZZXX0193	18' 2" x 18' 2" (5,54m x 5,54m)	1' 7" (0,49m)	6	4	499 lbs (227 kg)	•	•	•	•	•	\$7,745
Wave Rider Seesaw	ZZXX0650	19' 11" x 13' 2" (6,06m x 4,01m)	1' 12" (0,6m)	2	2	168 lbs (76 kg)	•	•	•	•	•	\$2,205
Bing Boing	ZZXX0044	17' 2" x 17' 2" (5,23m x 5,23m)	1' 6" (0,45m)	4	4	276 lbs (125 kg)	•	•	•	•	•	\$4,025
Nucleo	ZZXX0083	17' 0" x 15' 7" (5,18m x 4,75m)	2' 0" (0,61m)	1	3	103 lbs (47 kg)	•	•	•	•	•	\$1,929

+CSA and EN compliant versions available.

All play equipment must be installed over an appropriate impact absorbing surface that complies with ASTM or CSA standards. See your Playworld representative for more information.



## Unity® Teeter Tunnel® w/ Perf Top

ZZXX0192 • AGES: 5-12

- Encourages socialization and cooperation as kids learn to work together to go up and down
- Unlike traditional seesaws, many kids can participate at once
- The cheerful shouts of the kids will make you think you're at the amusement park!
- Many ways to ride—stand, sit, lie down, or hang out in the tunnel for a different experience
- Engages core muscles as kids work to stay balanced
- Bumpers included
- Perforated roof shown. Also available with Lexan® top.



## Seesaws

ZZXX0605 • AGES: 5-12

- 4-seat version shown; 2-seat option available, ZZXX0604
- Tires shown are included



## Duo Seesaws

ZZXX0596 • AGES: 2-12

- Ideal for building strength & coordination
- Available w/out Backrests, ZZXX0595



## Quattro Seesaws

ZZXX0598 • AGES: 2-12

- Unique spring design prevents bottoming out for safer play
- Available w/out Backrests, ZZXX0597

PRODUCT	ITEM	SPACE REQUIRED	FALL HEIGHT	USERS	INSTALL HOURS	WEIGHT	ADA	ASTM F1487	CPSC PUB.225	CAV/GSA Z614	EN1176	APPROX. PRICE
Unity® Teeter Tunnel® w/ Perf Top	ZZXX0192	24' 10" x 14' 2" (7,56m x 4,33m)	2' 10" (0,86m)	10	12	910 lbs (413 kg)	•	•	•	•	•	\$11,639
Seesaws 4-Seat	ZZXX0605	24' 1" x 17' 5" (7,34m x 5,31m)	3' 3" (0,99m)	4	4	324 lbs (147 kg)	•	•	•			\$3,489
Seesaws 2-Seat	ZZXX0604	24' 1" x 14' 10" (7,34m x 4,52m)	3' 3" (0,99m)	2	3	171 lbs (78 kg)	•	•	•			\$1,935
Duo Seesaws With Backrests	ZZXX0596	20' 3" x 13' 3" (6,17m x 4,04m)	2' 1" (0,63m)	2	3	210 lbs (96 kg)	•	•	•			\$3,805
Duo Seesaws Without Backrests	ZZXX0595	19' 8" x 13' 3" (6m x 4,04m)	2' 1" (0,63m)	2	3	197 lbs (90 kg)	•	•	•			\$3,505
Quattro Seesaws With Backrests	ZZXX0598	20' 6" x 15' 8" (6,25m x 4,78m)	2' 1" (0,63m)	6	5	483 lbs (219 kg)	•	•	•			\$7,245
Quattro Seesaws Without Backrests	ZZXX0597	19' 10" x 15' 8" (6,04m x 4,78m)	2' 1" (0,63m)	6	5	456 lbs (207 kg)	•	•	•			\$6,635



Sidewinder Cycle with Sidecar

ZZXX0584 • AGES: 2-5

- Also available w/out Sidecar, ZZXX0583



Freddy Firetruck

ZZXX0620 • AGES: 2-12



Bernie Bus

ZZXX0622 • AGES: 2-12

## Spring Mates®



Chipmunk

ZZXX0737 • AGES: 2-5



Duck

ZZXX0721 • AGES: 2-5



Turtle

ZZXX0741 • AGES: 2-5



Pony

ZZXX0725 • AGES: 2-5

PRODUCT	ITEM	SPACE REQUIRED	FALL HEIGHT	USERS	INSTALL HOURS	WEIGHT	ADA	ASTM F1487	CPSIC PUB.325	CAN/CSA Z614	EN1176	APPROX. PRICE
Classic Spring Riders Sidewinder Cycle with Sidecar	ZZXX0584	15' 3" x 15' 1" (4,65m x 4,6m)	2' 4" (0,71m)	2	3	130 lbs (59 kg)	•	•	•	•	•	\$3,379
Classic Spring Riders Sidewinder Cycle	ZZXX0583	15' 3" x 13' 3" (4,65m x 4,05m)	2' 4" (0,71m)	1	2	67 lbs (31 kg)	•	•	•	•	•	\$2,059
Freddy Firetruck Spring Mount	ZZXX0620	22' 3" x 18' 8" (6,78m x 5,7m)	2' 5" (0,73m)	9	10	752 lbs (342 kg)	•	•	•	•	•	\$9,679
Bernie Bus Spring Mount	ZZXX0622	22' 0" x 18' 8" (6,71m x 5,7m)	2' 3" (0,69m)	9	10	657 lbs (298 kg)	•	•	•	•	•	\$8,825
Spring Mates® Chipmunk	ZZXX0737	14' 6" x 13' 4" (4,41m x 4,08m)	1' 10" (0,55m)	1	2	68 lbs (31 kg)	•	•	•	•	•	\$1,379
Spring Mates® Duck	ZZXX0721	14' 3" x 13' 3" (4,34m x 4,04m)	1' 11" (0,58m)	1	2	64 lbs (29 kg)	•	•	•	•	•	\$1,375
Spring Mates® Turtle	ZZXX0741	14' 3" x 13' 2" (4,33m x 4,02m)	1' 12" (0,6m)	1	2	65 lbs (30 kg)	•	•	•	•	•	\$1,379
Spring Mates® Pony	ZZXX0725	14' 6" x 13' 4" (4,41m x 4,06m)	1' 10" (0,57m)	1	2	70 lbs (32 kg)	•	•	•	•	•	\$1,389

+CSA and EN compliant versions available.

All play equipment must be installed over an appropriate impact absorbing surface that complies with ASTM or CSA standards. See your Playworld representative for more information.

All products on this page are also available with sound.  
Contact your local Playworld representative for more information.



**Boat** w/out Sound  
ZZXX0551 • AGES: 2-5



**Truck** w/out Sound  
ZZXX0557 • AGES: 2-5



**Airplane** w/out Sound  
ZZXX0553 • AGES: 2-5



**Car** w/out Sound  
ZZXX0555 • AGES: 2-5



**Funky Animals Bumble Bee**  
w/out Sound  
ZZXX0567 • AGES: 2-5



**Funky Animals Cow**  
w/out Sound  
ZZXX0561 • AGES: 2-5



**Funky Animals Ladybug**  
w/out Sound  
ZZXX0565 • AGES: 2-5



**Funky Animals Horse**  
w/out Sound  
ZZXX0563 • AGES: 2-5

PRODUCT	ITEM	SPACE REQUIRED	FALL HEIGHT	USERS	INSTALL HOURS	WEIGHT	ADA	ASTM F1487	CPSC PUB.325	CAV/CSA Z614	EN1176	APPROX. PRICE
Boat Without Sound	ZZXX0551	15' 0" x 13' 11" (4,57m x 4,24m)	1' 5" (0,43m)	1	2	84 lbs (39 kg)	•	•	•	•	•	\$2,215
Truck Without Sound	ZZXX0557	15' 0" x 13' 10" (4,57m x 4,22m)	1' 5" (0,43m)	1	2	88 lbs (40 kg)	•	•	•	•	•	\$2,215
Airplane Without Sound	ZZXX0553	15' 0" x 13' 10" (4,57m x 4,22m)	1' 5" (0,43m)	1	2	83 lbs (38 kg)	•	•	•	•	•	\$2,215
Car Without Sound	ZZXX0555	15' 0" x 13' 10" (4,57m x 4,22m)	1' 5" (0,43m)	1	2	85 lbs (39 kg)	•	•	•	•	•	\$2,215
Bumble Bee Without Sound	ZZXX0567	15' 1" x 13' 4" (4,6m x 4,06m)	1' 8" (0,5m)	1	2	52 lbs (24 kg)	•	•	•	•	•	\$1,379
Cow Without Sound	ZZXX0561	15' 4" x 13' 4" (4,67m x 4,06m)	1' 8" (0,5m)	1	2	50 lbs (23 kg)	•	•	•	•	•	\$1,379
Ladybug Without Sound	ZZXX0565	14' 10" x 13' 4" (4,52m x 4,06m)	1' 8" (0,5m)	1	2	49 lbs (23 kg)	•	•	•	•	•	\$1,379
Horse Without Sound	ZZXX0563	15' 6" x 13' 4" (4,73m x 4,06m)	1' 8" (0,5m)	1	2	51 lbs (23 kg)	•	•	•	•	•	\$1,379

ZoomTrax delights users as they soar from one end to another suspended along an overhead rail! Each unit accommodates one rider with the option of a standard disc-style or accessible seat.



### ZoomTrax with Accessible Seat

ZZXX1138 • AGES: 5-12

- Accessible seat for ZoomTrax includes an over-the-shoulder harness that snap-locks into place
- High-angled back
- Contoured sides for increased support

TOP INCLUSIVE PRODUCT

### ZoomTrax with Disc Seat

ZZXX1136 • AGES: 5-12

- Seat lets users glide from one end to the other while suspended along an overhead rail
- Accommodates one rider on a disc-style seat
- "Launch pad" on either end lets kids push off to propel themselves down the rail



### ZoomTrax Add-A-Bay Options

AGES: 5-12

- Add-A-Bay connects to ZoomTrax units
- Accommodates one rider on a disc-style or accessible seat

TOP INCLUSIVE PRODUCT

PRODUCT	ITEM	SPACE REQUIRED	FALL HEIGHT	USERS	INSTALL HOURS	WEIGHT	ADA	ASTM F1487	CPSC PUB.325	CAV/CSA Z614	EN1176	APPROX. PRICE
ZoomTrax with Accessible Seat	ZZXX1138	52' 2" x 24' 10" (15,9m x 7,57m)	1' 6" (0,46m)	1	18	1061 lbs (482 kg)	•	•	•	•		\$12,221
ZoomTrax Add-A-Bay with Accessible Seat	ZZXX1139	52' 2" x 12' 4" (15,9m x 3,75m)	1' 6" (0,46m)	1	16	791 lbs (359 kg)	•	•	•	•		\$10,893
ZoomTrax with Disc Seat	ZZXX1136	57' 9" x 24' 10" (17,6m x 7,57m)	1' 4" (0,4m)	1	18	1242 lbs (564 kg)	•	•	•	•		\$11,496
ZoomTrax Add-A-Bay Options with Disc Seat	ZZXX1137	57' 9" x 12' 4" (17,6m x 3,75m)	1' 4" (0,4m)	1	16	973 lbs (442 kg)	•	•	•	•		\$10,344

+CSA and EN compliant versions available.

All play equipment must be installed over an appropriate impact absorbing surface that complies with ASTM or CSA standards. See your Playworld representative for more information.



### LiveWire Zip Line™

ZZXX1145 • AGES: 5-12

- Kids will line up to take their turn on this exhilarating ride!
- Stand or sit on this 80' (24,4m) long zip line with sleek sculptural styling
- Perceived element of risk; zip line is safe and low to the ground



### Vaquero

ZZXX0149 • AGES: 5-12

- This fun ride can accommodate a large group of kids
- Kids can sit, sway, and rock, pushing with their legs
- Younger children can sit while parents use handles to give a gentle ride
- Unique saddle design; holes will accommodate multiple ways for kids to sit



### Monorail

350-MONO • AGES: 5-12

- Patented air brakes for smooth, safe stop
- Cantilever posts clear path for safer use

### Cruise Line™

ZZXX0355 • AGES: 5-12

- Unique ride gives kids the thrill of something exciting and new with perceived risk and speed
- Riders can sit back-to-back, face-to-face, alone, or even lie down
- Children can imagine they're flying, or create new games and take turns
- Cruise Line provides opportunities for inclusive play, exercise, and cooperative play



**TOP INCLUSIVE PRODUCT**

PRODUCT	ITEM	SPACE REQUIRED	FALL HEIGHT	USERS	INSTALL HOURS	WEIGHT	ADA	ASTM F1487	CPSC PUB.225	CAN./CSA Z614	EN1176	APPROX. PRICE
LiveWire Zip Line™	ZZXX1145	112' 11" x 23' 7" (34,42m x 7,19m)	5' 6" (1,68m)	3	32	1702 lbs (772 kg)	•	•	•	•	•	\$20,255
Vaquero	ZZXX0149	30' 4" x 30' 4" (9,24m x 9,24m)	2' 2" (0,66m)	6	8	533 lbs (242 kg)	•	•	•	•	•	\$7,045
Monorail	350-MONO	31' 4" x 15' 2" (9,55m x 4,62m)	7' 0" (2,13m)	1	6	333 lbs (151 kg)	•	•	•	+	•	\$7,201
Cruise Line™	ZZXX0355	41' 5" x 23' 6" (12,62m x 7,16m)	2' 3" (0,69m)	6	18	957 lbs (435 kg)	•	•	•	•	•	\$15,069



### Unity® Hoopla Swing

350-HOOPLA • AGES: 2-12

**TOP INCLUSIVE PRODUCT**



### Unity® Basket Swing

350-BASKET • AGES: 2-12

**TOP INCLUSIVE PRODUCT**



### Unity® Basket Swing Add-A-Bay

350-BASKET-ADD • AGES: 2-12

**TOP INCLUSIVE PRODUCT**



### Classic Standard Swings

SWING-8-6 • AGES: 2-12

- Slash-proof, black belt swing seats with zinc coated chains
- 8' (2,44m) high top rail and 6 seats
- Also available in 10' (3,05m) height
- Available with anti-wrap swing hanger



### Single Post Swing with Toddler Beam

SWING-SP-TOD • AGES: 2-12

- Two black belt swing seats and one toddler seat with zinc coated chains included
- 8' (2,44m) tall with 5" (12,7cm) outer diameter end posts
- Also available without toddler beam



### Early Childhood T-Swing

ZZXX0822 • AGES: 2-5

- Two black, slash-proof toddler seats with zinc coated chains included
- 7' (2,13m) tall with 3-1/2" (8,8cm) diameter posts



PRODUCT	ITEM	SPACE REQUIRED	FALL HEIGHT	USERS	INSTALL HOURS	WEIGHT	ADA	ASTM F1487	CPSC PUB-225	CAN/CSA Z614	EM176	APPROX. PRICE
Unity®Hoopla Swing	350-HOOPLA	26' 7" x 27' 4" (8,1m x 8,33m)	7' 11" (2,41m)	4	5	232 lbs (106 kg)	•	•	•	•	•	\$9,010
Unity®Hoopla Swing Add-A-Bay	350-HOOPLA-ADD	+ 15' 0" (x 4,57m)	7' 11" (2,41m)	4	5	247 lbs (113 kg)	•	•	•	•	•	\$9,320
Unity®Basket Swing Add-A-Bay	350-BASKET-ADD	+ 15' 0" (x 4,57m)	7' 11" (2,41m)	4	5	281 lbs (128 kg)	•	•	•	•	•	\$9,660
Unity®Basket Swing	350-BASKET	26' 7" x 27' 4" (8,1m x 8,33m)	7' 11" (2,41m)	4	5	266 lbs (121 kg)	•	•	•	•	•	\$9,350
Classic Standard Swings6-Seats	SWING-8-6	48' 8" x 32' 2" (14,83m x 9,81m)	8' 0" (2,44m)	6	8	504 lbs (229 kg)	•	•	•	•	+	\$4,187
Classic Standard Swings4-Seats	SWING-8-4	38' 2" x 32' 2" (11,63m x 9,81m)	8' 0" (2,44m)	4	6	362 lbs (165 kg)	•	•	•	•	+	\$2,928
Classic Standard Swings2-Seats	SWING-8-2	27' 7" x 32' 2" (8,41m x 9,81m)	8' 0" (2,44m)	2	4	220 lbs (100 kg)	•	•	•	•	+	\$1,669
Single Post Swings2-Seat	SWING-SP	24' 1" x 32' 4" (7,34m x 9,85m)	8' 0" (2,44m)	2	3	276 lbs (125 kg)	•	•	•	•	+	\$1,809
Single Post Swing with Toddler Beam	SWING-SP-TOD	28' 8" x 32' 4" (8,74m x 9,85m)	8' 0" (2,44m)	3	4	333 lbs (151 kg)	•	•	•	•	+	\$2,758
Early Childhood T-Swing	ZZXX0822	22' 7" x 20' 4" (6,88m x 6,2m)	8' 0" (2,44m)	1	2	244 lbs (111 kg)	•	•	•	•	+	\$1,965

+CSA and EN compliant versions available.

All play equipment must be installed over an appropriate impact absorbing surface that complies with ASTM or CSA standards. See your Playworld representative for more information.

## Heavy Duty Swings

SWING-HD-8-4 • AGES: 2-12

- 2-3/8" (6,03cm) outer diameter end posts and 3-1/2" (8,8cm) outer diameter top rail
- Four slash-proof, black belt swing seats with zinc coated chains
- Also available in 10' height
- 2, 4, or 6 seats options



## Swing Along

SWING-ALONG-500 • AGES: 2-5

- Multigenerational swing features face-to-face seats: one for children under five and one for a sibling, parent, or caregiver
- Also available in 3-1/2" (8,8cm)
- Add-a-bay options also available



## Tire Swing

SWING-500-TIRE • AGES: 2-12

- 5" (12,7cm) diameter end posts
- Top rail is made from 11-gauge galvanized steel
- Add-a-bay option also available



## Arch Swings

500-ARCH • AGES: 2-12

- 5" (12,7cm) outer diameter aluminum arch frame and two black belt swing seats with zinc coated chains
- Also available in 3-1/2" (8,8cm)
- Add-a-bay options also available

## Swing Along Seat

AGES: 2-5

- Deeper seat with chain suspension in front of toddler provides more support and multiple, easy handholds
- Promotes social, emotional, visual, vestibular, proprioceptive, and language development
- Use with exclusive Swing Along bay requiring less surfacing or with many of our other swing frames (sold separately)



## Accessible Swing Seat

AGES: 2-12

- Available in 7' (2,13m), 8' (2,44m), and 10' (3,05m) top rail versions
- Can be used on many of the swing sets shown here



**TOP INCLUSIVE PRODUCT**

**TOP INCLUSIVE PRODUCT**

PRODUCT	ITEM	SPACE REQUIRED	FALL HEIGHT	USERS	INSTALL HOURS	WEIGHT	ADA	ASTM F 487	CPSC PUB.325	CAN./CSA Z614	EN1176	APPROX. PRICE
Heavy Duty Swings 6-Seats	SWING-HD-8-6	54' 7" x 32' 4" (16,64m x 9,85m)	8' 0" (2,44m)	6	8	691 lbs (314 kg)	•	•	•	•	•	\$5,723
Heavy Duty Swings 4-Seats	SWING-HD-8-4	43' 10" x 32' 4" (13,36m x 9,85m)	8' 0" (2,44m)	4	6	515 lbs (234 kg)	•	•	•	•	•	\$3,764
Heavy Duty Swings 2-Seats	SWING-HD-8-2	33' 1" x 32' 4" (10,08m x 9,85m)	8' 0" (2,44m)	2	4	338 lbs (154 kg)	•	•	•	•	•	\$2,255
Swing Along	SWING-ALONG-500	19' 7" x 32' 5" (5,97m x 9,88m)	8' 0" (2,44m)	2	5	219 lbs (100 kg)	•	•	•	•	•	\$3,699
Swing Along Add-a-Bay Unit	SWING-ALONG-500-ADD	+ 7' 2" ( x 2,19m)	8' 0" (2,44m)	2	5	151 lbs (69 kg)	•	•	•	•	•	\$2,885
Tire SwingsTire Swing	SWING-500-TIRE	27' 11" x 22' 5" (8,51m x 6,83m)	6' 11" (2,11m)	3	4	254 lbs (115 kg)	•	•	•	•	•	\$4,419
Tire Swing Add-A-Bay Unit	SWING-500-TIRE-ADD	+ 22' 5" ( x 6,83m)	6' 11" (2,11m)	3	4	199 lbs (91 kg)	•	•	•	•	•	\$2,865
Arch Swings 2-Seats	500-ARCH	23' 5" x 32' 5" (7,14m x 9,88m)	8' 0" (2,44m)	2	4	234 lbs (106 kg)	•	•	•	•	•	\$3,112
Arch Swing Add-A-Bay Unit	500-ARCH-ADD	+ 11' 0" ( x 3,35m)	8' 0" (2,44m)	2	3	166 lbs (75 kg)	•	•	•	•	•	\$2,149
Arch Swings 2-Seats	350-ARCH	23' 2" x 32' 4" (7,06m x 9,85m)	8' 0" (2,44m)	2	4	299 lbs (136 kg)	•	•	•	•	•	\$2,721
Arch Swing Add-A-Bay Unit	350-ARCH-ADD	+ 10' 11" ( x 3,33m)	8' 0" (2,44m)	2	3	184 lbs (84 kg)	•	•	•	•	•	\$1,757



### Unity® Slide Climber

ZZXX0346 • AGES: 5-12

- The thrill of a slide and so much more!
- Three different climbers for a variety of challenge levels
- Tube at the top is entry to slide and a gathering point
- Children use the space underneath to socialize and play games



### Nuvo™ 360° Spiral Slide

ZZXX0630 • AGES: 2-12

- Corkscrew slide features a one-piece bedway and canopy with molded-in handhold
- Graceful curves and swirls match Nuvo style
- Deck height is 6' (1,83m)



### Twist and Shout Slide

ZZCH2728 • AGES: 2-12

- Curved, textured bedways give a thrilling side-to-side motion
- Deck height is 4' (1,22m)



### Rumble Seat Slide

ZZCH2738 • AGES: 2-12

- Bumpy slide helps build multi-sensory awareness
- Deck height is 5' (1,52m)



### Boulder Hill Slide

CB-1300 • AGES: 2-12

- Build a slide into your site's landscape for the ultimate wow factor
- Bring the fun of sliding into the natural setting, featuring a boulder entrance
- Slide is segmented for design flexibility; choose from hundreds of configurations



### Glide Slide

ZZCH3536 • AGES: 2-12

- Durable one-piece design
- Available from three deck heights: 4' (1,22m, shown), 5' (1,52m), and 6' (1,83m)

PRODUCT	ITEM	SPACE REQUIRED	FALL HEIGHT	USERS	INSTALL HOURS	WEIGHT	ADA	ASTM F1487	CPSC PUB-302	CAV/CSA Z614	EN1176	APPROX. PRICE
Unity® Slide Climber	ZZXX0346	33' 11" x 19' 7" (10,33m x 5,96m)	8' 7" (2,62m)	10	12	896 lbs (407 kg)	•	•	•	•	•	\$14,759
Nuvo™ 360° Spiral Slide	ZZXX0630	22' 10" x 17' 5" (6,96m x 5,31m)	6' 0" (1,83m)	4	8	900 lbs (409 kg)	•	•	•	•	•	\$10,475
Challengers® Twist and Shout Slide	ZZCH2728	24' 11" x 16' 2" (7,6m x 4,93m)	4' 0" (1,22m)	4	8	475 lbs (216 kg)	•	•	•	+	+	\$6,539
Challengers® Rumble Seat Slide	ZZCH2738	25' 2" x 16' 5" (7,67m x 5m)	5' 0" (1,52m)	6	8	504 lbs (229 kg)	•	•	•	+	+	\$7,809
Boulder Hill Slide	CB-1300	29' 8" x 15' 4" (9,04m x 4,67m)	7' 0" (2,13m)	9	6	1211 lbs (549 kg)	•	•	•	•	•	\$10,495
Glide Slide	ZZCH3536	24' 6" x 15' 2" (7,48m x 4,61m)	4' 0" (1,22m)	4	6	384 lbs (174 kg)	•	•	•	+	•	\$5,679



## Adventure Tubes

Originally introduced in 2007, Adventure Tubes have been reinvented with a daring new design to take kids beyond a typical cylindrical tube experience into a more modern, complex space that's ripe for exploration. Made of sturdy rotomolded plastic with perforated steel windows for high visibility, Adventure Tubes will withstand the escapades of countless adventurers.



Nature Themed Panel



Geometric Panel



### High Climb Adventure Tube

ZZUN5215 • AGES: 2-12



### Horizontal S & 90° Adventure Tube

ZZUN5216 • AGES: 2-12

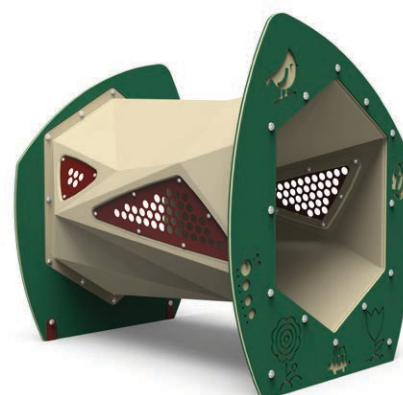

### Passage Adventure Tube

ZZUN5213 • AGES: 2-12

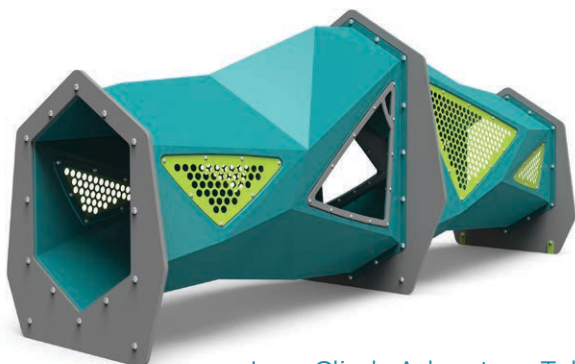

### Low Climb Adventure Tube

ZZUN5214 • AGES: 2-12



### Log Tube

ZZUN5197 • AGES: 2-12

PRODUCT	ITEM	SPACE REQUIRED	FALL HEIGHT	USERS	INSTALL HOURS	WEIGHT	ADA	ASTM F1487	CPSC PUB.325	CAV/GSA 2614	EN1176	APPROX. PRICE
High Climb Adventure Tubes	ZZUN5215	24' 2" x 15' 10" (7,37m x 4,82m)	3' 8" (1,12m)	7	3.5	376 lbs (171 kg)	•	•	•	•		\$6,069
Horizontal S & 90° Adventure Tube	ZZUN5216	18' 0" x 18' 3" (5,49m x 5,56m)	0' 8" (0,21m)	4	1.5	93 lbs (43 kg)	•	•	•	•		\$1,679
Passage Adventure Tube	ZZUN5213	16' 0" x 15' 3" (4,88m x 4,65m)	0' 12" (0,29m)	2	1.5	56 lbs (26 kg)	•	•	•	•		\$1,095
Low Climb Adventure Tube	ZZUN5214	23' 11" x 15' 10" (7,29m x 4,82m)	0' 11" (0,28m)	6	3.5	223 lbs (101 kg)	•	•	•	•		\$3,305
Log Tube	ZZUN5197	18' 0" x 15' 11" (5,49m x 4,84m)	0' 7" (0,18m)	3	4	137 lbs (63 kg)	•	•	•	•		\$3,185



### Balance Trax

BT-1201 • AGES: 2-12

- Designed for children to improve their balance skills
- Uneven platforms provide a greater challenge for kids with special needs
- Sturdy handrails encourage safe risk taking

TOP INCLUSIVE PRODUCT



### Unity® Steppers

AGES: 2-12

- Available in small, medium, and large
- Multi-functional stepping "stones" connect equipment, and provide social gathering places
- Opportunities for pretend games like crossing a river

TOP INCLUSIVE PRODUCT

### Bounce Button

ZZUN7090 • AGES: 5-12

- Range of motion determined by user's weight

### Parallel Bars

ZZUN5750 • AGES: 5-12

- Builds upper-body strength and stamina

### Balance Beams

AGES: 2-12

- Made of steel with galvanized steel support legs
- Helps develop balance and coordination
- Available in Curved (as shown) and Dura (Straight) Balance Beam options

PRODUCT	ITEM	SPACE REQUIRED	FALL HEIGHT	USERS	INSTALL HOURS	WEIGHT	ADA	ASTM F1487	CPSC PUB.325	CAV/CSA Z614	EN1176	APPROX. PRICE
Balance Trax	BT-1201	38' 5" x 21' 3" (11,71m x 6,48m)	1' 4" (0,41m)	20	24	930 lbs (422 kg)	•	•	•	•	•	\$13,890
A. Balance Trax Boomerang	ZZX0345	18' 0" x 14' 11" (5,49m x 4,55m)	0' 8" (0,2m)	2	3	123 lbs (56 kg)	•	•	•	•	•	\$1,589
B. Balance Trax Pond	ZZX0341	13' 2" x 13' 2" (4,01m x 4,01m)	0' 8" (0,2m)	1	1	17 lbs (8 kg)	•	•	•	•	•	\$475
C. Balance Trax Dunes	ZZX0343	19' 0" x 14' 2" (5,79m x 4,31m)	1' 1" (0,33m)	2	4	152 lbs (69 kg)	•	•	•	•	•	\$1,925
D. Balance Trax Snake	ZZX0344	19' 9" x 16' 3" (6,02m x 4,95m)	0' 8" (0,2m)	2	4	165 lbs (75 kg)	•	•	•	•	•	\$2,299
E. Balance Trax Mountain (Surf Mt)	ZZX0342	19' 0" x 14' 2" (5,79m x 4,31m)	1' 4" (0,41m)	2	4	149 lbs (68 kg)	•	•	•	•	•	\$2,289
F. Unity® Steppers Large	ZZUN7138	15' 10" x 15' 10" (4,82m x 4,82m)	1' 7" (0,48m)	4	2	128 lbs (59 kg)	•	•	•	•	•	\$1,795
G. Unity® Steppers Medium	ZZUN7137	14' 0" x 14' 0" (4,28m x 4,28m)	0' 12" (0,3m)	1	1	55 lbs (25 kg)	•	•	•	•	•	\$1,139
H. Unity® Steppers Small	ZZUN7136	13' 4" x 13' 4" (4,06m x 4,06m)	0' 9" (0,22m)	1	1	30 lbs (14 kg)	•	•	•	•	•	\$649
Bounce Button	ZZUN7090	15' 2" x 15' 2" (4,62m x 4,62m)	1' 7" (0,49m)	1	1	32 lbs (15 kg)	•	•	•	•	•	\$725
Parallel Bars	ZZUN5750	23' 6" x 13' 10" (7,16m x 4,22m)	2' 8" (0,81m)	3	2	103 lbs (47 kg)	•	•	•	•	•	\$2,205
Balance Beams Curved	ZZX1020	23' 0" x 16' 0" (7,01m x 4,88m)	1' 4" (0,41m)	2	2	62 lbs (29 kg)	•	•	•	•	•	\$765
Balance Beams Dura (Straight)	ZZUN6500	22' 0" x 12' 6" (6,71m x 3,81m)	1' 0" (0,3m)	2	1	59 lbs (27 kg)	•	•	•	•	•	\$625



## Sidewalk

ZZUN7100 • AGES: 2-12

- Sections move based on child's weight
- Develops sense of balance, coordination, and motor skills

## Stationary Buttons

AGES: 2-12

- Can be mounted with other buttons at different heights to create a staircase or walkway
- Available in 1' (0,3m), 1' 6" (0,46m), and 2' (0,61m) heights



## Tetherball

ZZXX1079 • AGES: 5-12

- Classic game of a ball on a rope that swings around a center post
- Ball features a recessed rope attachment for extra protection
- Replacement ball with rope also available



## Toss-Up

ZZXX1050 • AGES: 2-12

- Unique funnel shape with four openings makes it even more fun to guess where the ball will come out
- Large capacity to receive more than one ball at a time for more fun



## Triple Shoot-Out

ZZXX1051 • AGES: 2-12

- Adjustable baskets create opportunity for challenge and growth
- Three baskets open up the imagination to create new games

**TOP INCLUSIVE PRODUCT**

PRODUCT	ITEM	SPACE REQUIRED	FALL HEIGHT	USERS	INSTALL HOURS	WEIGHT	ADA	ASTM F1487	CPSC PUB.325	CAN./CSA Z614	EN1176	APPROX. PRICE
A. Sidewalk	ZZUN7100	22' 3" x 15' 4" (6,77m x 4,67m)	1' 6" (0,47m)	3	2	167 lbs (76 kg)	•	•	•	•	•	\$2,819
B. Stationary Buttons 1' (0,31m)	ZZUN7140	13' 2" x 13' 2" (4,01m x 4,01m)	1' 0" (0,3m)	1	1	28 lbs (13 kg)	•	•	•	•	•	\$525
Tetherball	ZZXX1079	12' 0" x 12' 0" (3,66m x 3,66m)	()	2	1	32 lbs (15 kg)						\$255
Tetherball Replacement Ball with Rope	ZZXX1080	-	-	2	0.25	1 lbs (1 kg)						\$59
Toss-Up	ZZXX1050	12' 0" x 12' 0" (3,66m x 3,66m)	()	8	1	110 lbs (50 kg)	•	•	•	•	•	\$969
Triple Shoot-Out	ZZXX1051	12' 0" x 12' 0" (3,66m x 3,66m)	()	8	2	309 lbs (141 kg)	•	•	•	•	•	\$3,435



### Home Dome

ZZXX0365 • AGES: 2-5

- The first play dome that doubles as a playhouse or clubhouse
- Spacing between rungs has been carefully designed for younger children for just the right amount of challenge and accomplishment
- Develops children's understanding of spatial relationships of their body in a space
- Develops upper-body strength by hanging and swinging, jumping, discovery of new climbing paths, and details within the dome
- Improves social skills through inventive physical and imaginative play



### Butterfly Climber

ZZXX0480 • AGES: 2-5

- Gives children a fun and safe place to practice their balance and coordination skills
- Hand-eye coordination improves as they use the handholds in the butterfly wings
- Encourages children to socialize and negotiate to pass one another
- Each colorful butterfly sold separately



### Flower Climber

ZZXX0479 • AGES: 2-5

- Safe, fun, and easy to engage; children will love climbing up, over, and through
- Children practice control and balance, and become aware of their body position in space



### Rhythm Wall

350-1431 • AGES: 2-12

- Connected panels of drums, chimes, bells, and horns encourage socialization and collaborative music-making
- Camber Half Square Roof provides economical sun protection



### Drum Set

ZZUN5049 • AGES: 2-12

- Three bongo-style drums in varying tones

PRODUCT	ITEM	SPACE REQUIRED	FALL HEIGHT	USERS	INSTALL HOURS	WEIGHT	ADA	ASTM F1487	CPSC PUB.325	CAV/CSA Z614	EM176	APPROX. PRICE
Home Dome	ZZXX0365	21' 10" x 22' 2" (6,65m x 6,76m)	4' 8" (1,43m)	8	9	427 lbs (194 kg)	•	•	•	•	•	\$10,189
Butterfly Climber	ZZXX0480	13' 4" x 13' 2" (4,05m x 4,01m)	0' 10" (0,25m)	1	1	40 lbs (19 kg)	•	•	•	•	•	\$669
Flower Climber	ZZXX0479	18' 9" x 15' 0" (5,72m x 4,57m)	4' 0" (1,22m)	3	2	91 lbs (42 kg)	•	•	•	•	•	\$1,679
Rhythm Wall	350-1431	23' 0" x 15' 10" (7,01m x 4,82m)	–	8	10	420 lbs (191 kg)	•	•	•	•	•	\$9,991
Drum Set	ZZUN5049	14' 5" x 16' 11" (4,39m x 5,15m)	–	2	3	122 lbs (55 kg)	•	•	•	•	•	\$1,915

+CSA and EN compliant versions available.

All play equipment must be installed over an appropriate impact absorbing surface that complies with ASTM or CSA standards. See your Playworld representative for more information.

## PlayExpress AGES: 2-5

Available in two color palettes; Primary is shown.

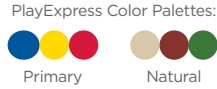

## Playdozer

ZZXX3230 • AGES: 2-12

- Colors as shown



## Sand & Water Table with LolloTops™

ZZXX1275 • AGES: 2-12

- Complete with three whimsical LolloTop post toppers
- Two-basin accessible table with drain plug and two multifunctional bin covers
- Also available without LolloTops (ZZXX1270)

## EZ-Digger

AGES: 2-12

- Features 360° rotation and dual hand controls
- Available in Accessible option (as shown) or with seat

**TOP INCLUSIVE PRODUCT**

PRODUCT	ITEM	SPACE REQUIRED	FALL HEIGHT	USERS	INSTALL HOURS	WEIGHT	ADA	ASTM F1487	CPSC PUB.325	CAN/CSA Z614	EN1176	APPROX. PRICE
A. PlayExpress The Engine Car	ZZXX3150	26' 4" x 15' 9" (8,03m x 4,81m)	2' 0" (0,61m)	10	10	773 lbs (351 kg)	•	•	•	•	•	\$11,619
B. PlayExpress The Sandbox Car	ZZXX3180	20' 1" x 15' 9" (6,12m x 4,81m)	–	10	5	458 lbs (208 kg)	•	•	•	•	•	\$5,825
C. PlayExpress The Tanker Car	ZZXX3195	19' 6" x 15' 1" (5,94m x 4,6m)	0' 9" (0,22m)	3	5	368 lbs (167 kg)	•	•	•	•	•	\$5,495
D. PlayExpress The Dining Car	ZZXX3170	17' 4" x 15' 9" (5,29m x 4,81m)	–	4	5	321 lbs (146 kg)	•	•	•	•	•	\$4,749
Playdozer	ZZXX3230	23' 8" x 16' 6" (7,21m x 5,03m)	3' 0" (0,91m)	6	8	521 lbs (236 kg)	•	•	•	•	•	\$9,915
Sand & Water Table with LolloTops™	ZZXX1275	21' 7" x 15' 2" (6,58m x 4,62m)	–	11	3	293 lbs (133 kg)	•	•	•	•	•	\$4,069
Sand & Water Table	ZZXX1270	20' 0" x 14' 6" (6,1m x 4,43m)	–	11	3	163 lbs (74 kg)	•	•	•	•	•	\$2,199
EZ-Digger Accessible	ZZXX0421	17' 4" x 8' 8" (5,28m x 2,64m)	–	1	1	50 lbs (23 kg)	•	•	•	•	•	\$1,389
EZ-Digger with Seat	ZZXX0416	15' 4" x 15' 4" (4,67m x 4,67m)	1' 4" (0,4m)	1	1	55 lbs (25 kg)	•	•	•	•	•	\$1,399

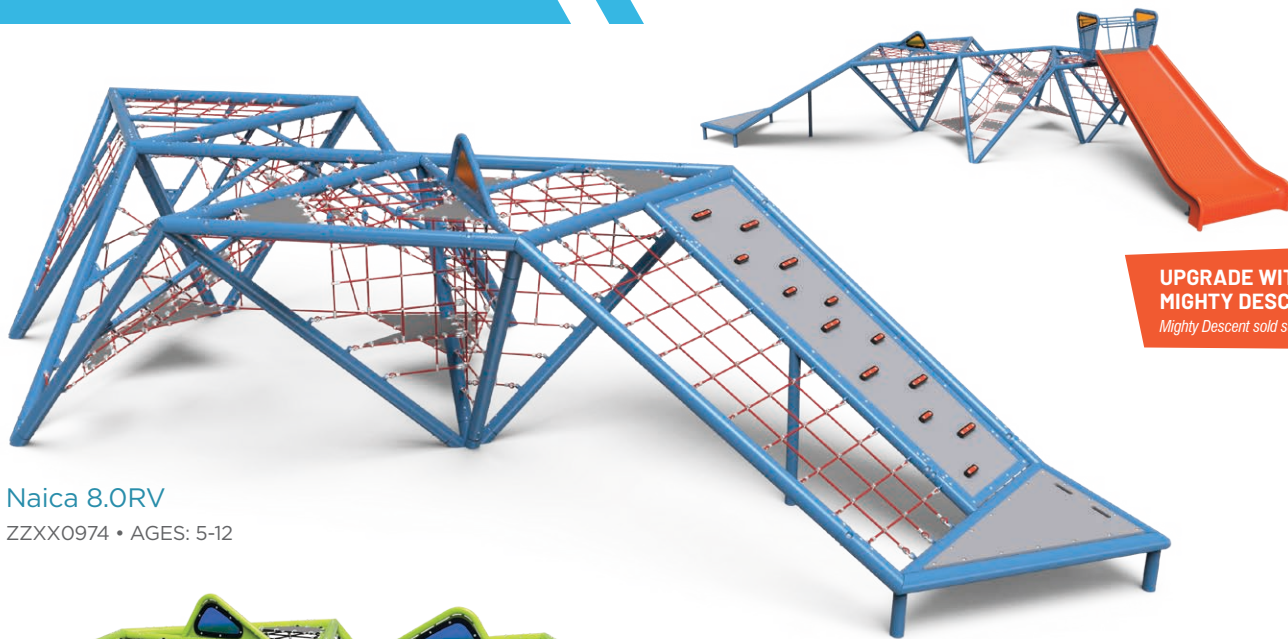

**UPGRADE WITH MIGHTY DESCENT!**

*Mighty Descent sold separately*

**Naica 8.0RV**

ZZXX0974 • AGES: 5-12

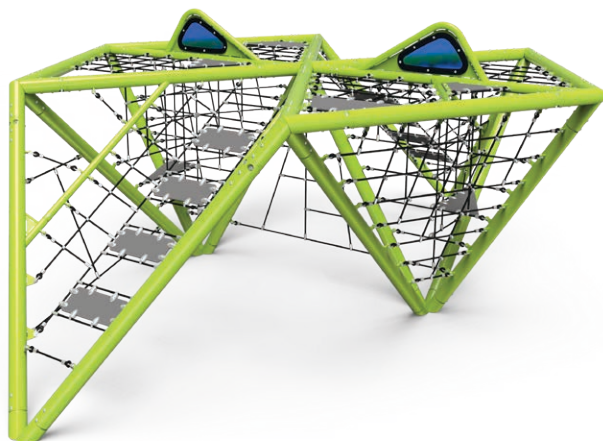

**Naica 6.0V**

ZZXX0972 • AGES: 5-12

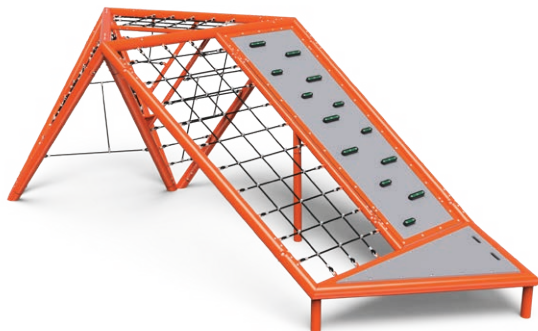

**Naica 4.0R**

ZZXX0973 • AGES: 5-12



**Naica 2.0V**

ZZXX0971 • AGES: 5-12

PRODUCT	ITEM	SPACE REQUIRED	FALL HEIGHT	USERS	INSTALL HOURS	WEIGHT	ADA	ASTM F1487	CPSC PUB.325	CAN/CSA Z614	EN1176	APPROX. PRICE
Naica™ 2.0V (Plastic)	ZZXX0971	24' 1" x 27' 11" (7,35m x 8,51m)	7' 2" (2,19m)	24	16	1344 lbs (610 kg)	•	•	•	•	•	\$28,000
Naica™ 2.0VSD (Plastic)	ZZXX0971SD	24' 1" x 27' 11" (7,35m x 8,51m)	7' 2" (2,19m)	24	12	1333 lbs (605 kg)	•	•	•	•	•	\$28,000
Naica™ 4.0R (Plastic)	ZZXX0973	35' 5" x 22' 10" (10,8m x 6,96m)	7' 2" (2,19m)	17	16	1477 lbs (670 kg)	•	•	•	•	•	\$32,900
Naica™ 4.0RSD (Plastic)	ZZXX0973SD	35' 5" x 22' 10" (10,8m x 6,96m)	7' 2" (2,19m)	17	8	1410 lbs (640 kg)	•	•	•	•	•	\$32,900
Naica™ 6.0V (Plastic)	ZZXX0972	30' 2" x 36' 2" (9,2m x 11,03m)	7' 2" (2,19m)	23	24	2375 lbs (1077 kg)	•	•	•	•	•	\$48,500
Naica™ 6.0VSD (Plastic)	ZZXX0972SD	30' 2" x 36' 2" (9,2m x 11,03m)	7' 2" (2,19m)	23	18	2360 lbs (1070 kg)	•	•	•	•	•	\$48,500
Naica™ 8.0RV (Plastic)	ZZXX0974	42' 10" x 36' 5" (13,05m x 11,1m)	7' 2" (2,19m)	23	48	3044 lbs (1381 kg)	•	•	•	•	•	\$68,900
Naica™ 8.0RVSD (Plastic)	ZZXX0974SD	42' 10" x 36' 5" (13,05m x 11,1m)	7' 2" (2,19m)	23	36	3044 lbs (1381 kg)	•	•	•	•	•	\$68,900
Mighty Descent to Quito/Naica	ZZXX1125	-	8' 0" (2,44m)	8	3	766 lbs (347 kg)	•	•	•	•	•	\$10,500
Mighty Descent to Quito/Naica (4in SM)	ZZXX1125SD	-	8' 0" (2,44m)	8	2	795 lbs (361 kg)	•	•	•	•	•	\$11,275

+CSA and EN compliant versions available.

All play equipment must be installed over an appropriate impact absorbing surface that complies with ASTM or CSA standards. See your Playworld representative for more information.



For more Quito see pages 12-13.

**UPGRADE WITH MIGHTY DESCENT!**  
Mighty Descent sold separately



**Quito™ (4in Surfacing)**

ZZXX1123 • AGES: 5-12

PRODUCT	ITEM	SPACE REQUIRED	FALL HEIGHT	USERS	INSTALL HOURS	WEIGHT	ADA	ASTM F1487	CPSC PUB.325	CAN./CSA Z614	EN1176	APPROX. PRICE
Quito™ (4in Surfacing)	ZZXX1123	31' 1" x 32' 3" (9,47m x 9,83m)	7' 0" (2,13m)	56	96	4327 lbs (1963 kg)	•	•	•	•	•	\$73,389
Quito™ (12in Surfacing)	ZZXX1124	31' 1" x 32' 3" (9,47m x 9,83m)	7' 0" (2,13m)	56	96	4393 lbs (1992 kg)	•	•	•	•	•	\$73,389
Mighty Descent to Quito/Naica	ZZXX1125	-	8' 0" (2,44m)	8	3	766 lbs (347 kg)	•	•	•	•	•	\$10,500
Mighty Descent to Quito/Naica (4in SM)	ZZXX1125SD	-	8' 0" (2,44m)	8	2	795 lbs (361 kg)	•	•	•	•	•	\$11,275



Shown with optional Sensory Connections (sold separately)

### Unity® Dome

ZZXX0366 • AGES: 5-12

- A play experience that brings everyone together
- Play in, on, and around
- Unique rings and rungs create new adventures and climbing challenges
- Perch points create special destinations
- Accessible for children in wheelchairs for more inclusive play
- Net tube climber inside creates different climbing experience
- The large opening enables a child in a wheelchair to be in the middle of the play

\*U.S. Patent D729,224S

**TOP INCLUSIVE PRODUCT**

Unity Dome Sensory Connections



Drum

Tambourine

Washboard

### Dome Sensory Connections

ZZXX0367 • AGES: 5-12



### Unity® Large Canopy

ZZXX0187 • AGES: 5-12

- Inspired by traditional monkey bars
- Designed so children gain a sense of achievement every time they play on it—traditional overhead measured success on crossing entire length
- Climbing cleats help everyone get started
- Non-linear canopy provides options for many different paths



### Unity® Web - Medium (Surf Mnt)

ZZXX1114S • AGES: 5-12

- Accommodates up to 20 users
- 10' (3,05m) height
- Designed for surface mount, but can be made in-ground using a footing kit (not included)

PRODUCT	ITEM	SPACE REQUIRED	FALL HEIGHT	USERS	INSTALL HOURS	WEIGHT	ADA	ASTM F1487	CPSC PUB.325	CAN/CSA Z614	EN1176	APPROX. PRICE
Unity® Dome	ZZXX0366	27' 0" x 27' 0" (8,23m x 8,23m)	7' 0" (2,13m)	17	20	601 lbs (273 kg)	•	•	•	•	•	\$19,829
Unity® Dome Sensory Connections	ZZXX0367	-	-	3	2	76 lbs (35 kg)	•	•	•	•	•	\$4,775
Unity® Large Canopy	ZZXX0187	25' 4" x 21' 1" (7,72m x 6,44m)	7' 4" (2,23m)	13	10	608 lbs (276 kg)	•	•	•	•	•	\$9,875
Unity® Web - Medium (Surf Mnt)	ZZXX1114S	26' 0" x 26' 0" (7,92m x 7,92m)	8' 0" (2,44m)	20	4	798 lbs (362 kg)	•	•	•	•	•	\$20,829
Unity® Web - Small (Surf Mnt)	ZZXX1115S	23' 0" x 23' 0" (7,01m x 7,01m)	6' 6" (1,98m)	12	3	615 lbs (279 kg)	•	•	•	•	•	\$16,109

+CSA and EN compliant versions available.

All play equipment must be installed over an appropriate impact absorbing surface that complies with ASTM or CSA standards. See your Playworld representative for more information.



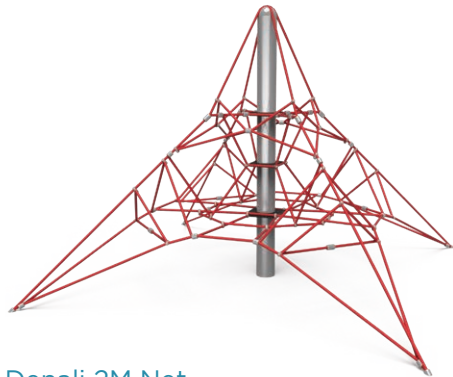

### Denali 2M Net

ZZXX1053 • AGES: 5-12

- Smaller unit is designed for younger children
- 2 meter height

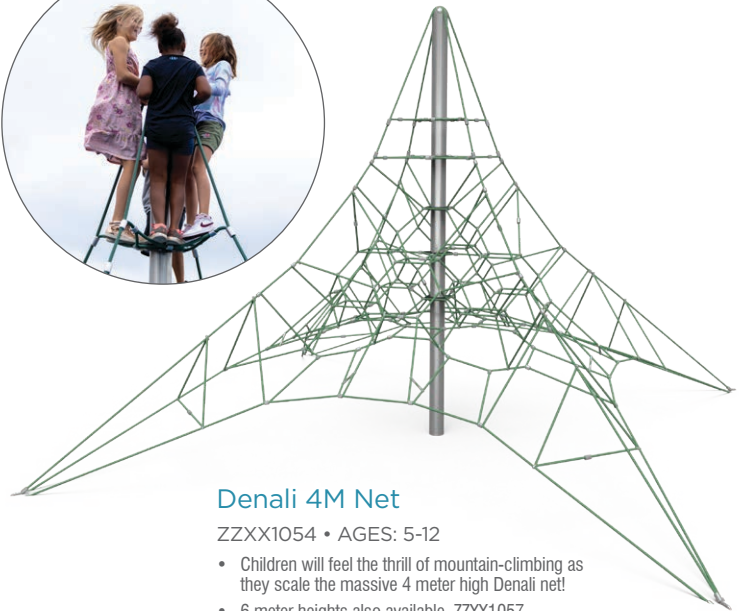

### Denali 4M Net

ZZXX1054 • AGES: 5-12

- Children will feel the thrill of mountain-climbing as they scale the massive 4 meter high Denali net!
- 6 meter heights also available, ZZXX1057

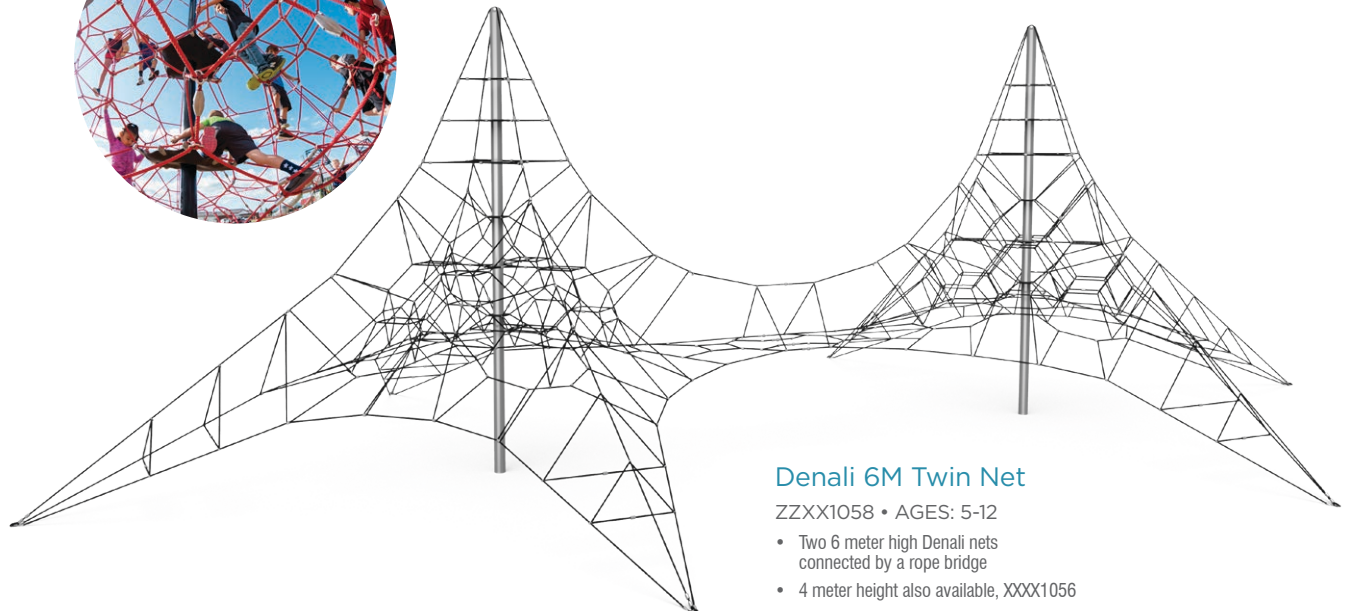

### Denali 6M Twin Net

ZZXX1058 • AGES: 5-12

- Two 6 meter high Denali nets connected by a rope bridge
- 4 meter height also available, XXXX1056

PRODUCT	ITEM	SPACE REQUIRED	FALL HEIGHT	USERS	INSTALL HOURS	WEIGHT	ADA	ASTM F1487	CPSC PUB.325	CAN./CSA Z864	EN1176	APPROX. PRICE
Denali 2M Net	ZZXX1053	25' 6" x 25' 6" (7,77m x 7,77m)	6' 0" (1,83m)	6	24	310 lbs (141 kg)	•	•	•	•	•	\$15,901
Denali 4M Net	ZZXX1054	37' 4" x 37' 4" (11,38m x 11,38m)	6' 0" (1,83m)	15	24	441 lbs (200 kg)	•	•	•	•	•	\$19,789
Denali 4 M Twin Net	ZZXX1056	55' 8" x 38' 7" (16,97m x 11,76m)	6' 0" (1,83m)	25	24	795 lbs (361 kg)	•	•	•	•	•	\$37,276
Denali 6M Net	ZZXX1057	48' 6" x 48' 6" (14,78m x 14,78m)	8' 0" (2,44m)	20	24	548 lbs (249 kg)	•	•	•	•	•	\$26,547
Denali 6M Twin Net	ZZXX1058	78' 9" x 50' 9" (24m x 15,47m)	8' 0" (2,44m)	30	24	1025 lbs (465 kg)	•	•	•	•	•	\$51,518

Climbing just got more exciting! Inspired by nature, ModPods were designed to be more challenging than a flat plane climber. Modularity gives ModPods flexibility for virtually endless design possibilities that support social and inclusive play.



ModPods™ MOD-194  
MOD-194 • AGES: 5-12

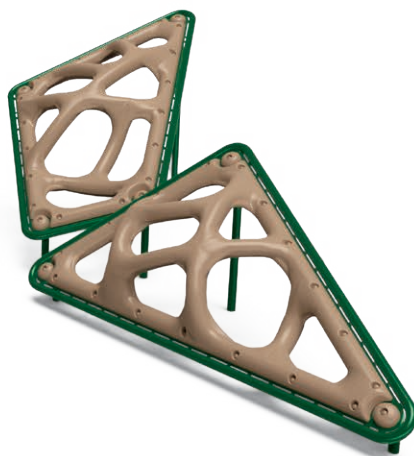

ModPods™ MOD-191  
MOD-191 • AGES: 5-12



ModPods™ MOD-193  
MOD-193 • AGES: 5-12

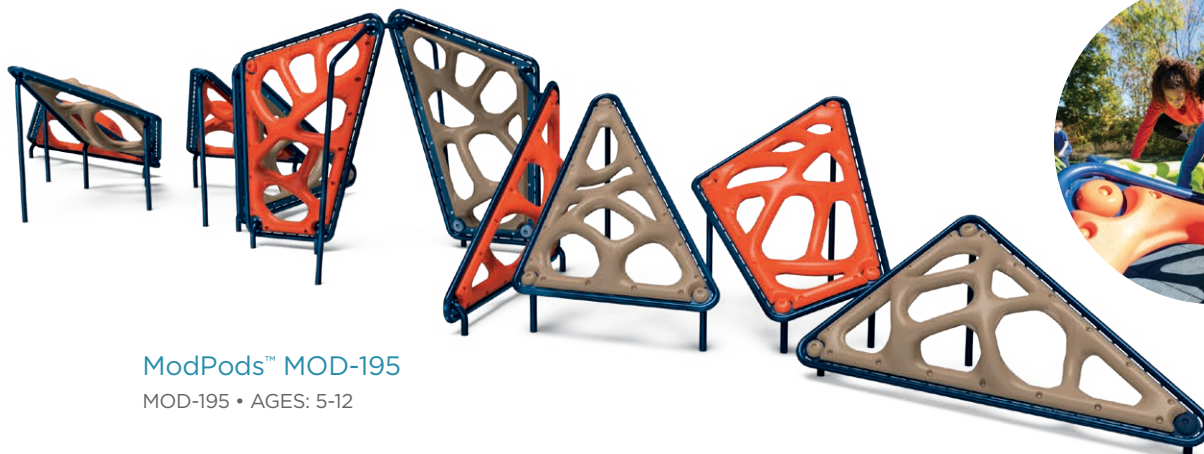

ModPods™ MOD-195  
MOD-195 • AGES: 5-12



For more ModPods™ see pages 105, 176.

PRODUCT	ITEM	SPACE REQUIRED	FALL HEIGHT	USERS	INSTALL HOURS	WEIGHT	ADA	ASTM F1487	CPSC PUB-328	CAN/CSA Z614	EN1176	APPROX. PRICE
ModPods™ MOD-194	MOD-194	44' 0" x 31' 0" (13,41m x 9,45m)	6' 0" (1,83m)	23	22	2010 lbs (912 kg)	•	•	•	•	•	\$24,961
ModPods™ MOD-191	MOD-191	29' 6" x 18' 8" (8,99m x 5,69m)	8' 5" (2,57m)	12	10	908 lbs (412 kg)	•	•	•	•	•	\$11,485
ModPods™ MOD-193	MOD-193	36' 0" x 31' 2" (10,97m x 9,5m)	8' 5" (2,57m)	24	20	1839 lbs (835 kg)	•	•	•	•	•	\$23,360
ModPods™ MOD-195	MOD-195	63' 7" x 34' 4" (19,38m x 10,46m)	8' 5" (2,57m)	36	32	2889 lbs (1310 kg)	•	•	•	•	•	\$36,441

+CSA and EN compliant versions available.

All play equipment must be installed over an appropriate impact absorbing surface that complies with ASTM or CSA standards. See your Playworld representative for more information.



### PlayCubes® 1.0

PLAYCUBES-1 • AGES: 2-12

- Pack a lot of play value into a small space
- Perfect for children who haven't learned to climb yet
- Builds imagination and increases spatial awareness
- Also available in metal

For more PlayCubes, visit: [Playworld.com/PlayCubes](http://Playworld.com/PlayCubes)

*For more PlayCubes® see pages 54-59.*

PRODUCT	ITEM	SPACE REQUIRED	FALL HEIGHT	USERS	INSTALL HOURS	WEIGHT	ADA	ASTM F1487	CPSC PUB.325	CAN./CSA Z864	EN1176	APPROX. PRICE
PlayCubes®1.0	PLAYCUBES-1	16' 4" x 16' 11" (4,98m x 5,16m)	4' 1" (1,24m)	4	2	153 lbs (70 kg)	•	•	•	•	•	\$3,725



**Jumble Gym**

ZZXX0430 • AGES: 5-12



**Cosmic Warp**

ZZXX0401 • AGES: 5-12



**Super Dome**

ZZXX0400 • AGES: 5-12



**Moon Rock Climber**

ZZXX0148 • AGES: 2-12

- Encourages exploration and discovery
- Space-themed, molded-in features under the climber include rockets, stars, and the solar system
- Kids will love to climb, jump, and hide underneath



**Whirlwind Climbers**

AGES: 5-12

- Unique, distinctive climber adds visual appeal and excitement to play areas
- Molded-in ribs, hand- and footholds provide safe, challenging climb
- Available in five heights; priced for 2' (0,61m)
- Use one or combine two or more to create your own design

**Summit Climbers**



**Ozarks**

ZZXX0461 • AGES: 5-12



**Sierra**

ZZXX0462 • AGES: 5-12



**Rockies**

ZZXX0463 • AGES: 5-12



**Appalachian**

ZZXX0464 • AGES: 5-12

PRODUCT	ITEM	SPACE REQUIRED	FALL HEIGHT	USERS	INSTALL HOURS	WEIGHT	ADA	ASTM F1487	CPSC PUB 325	CAN/CSA Z614	EN1176	APPROX. PRICE
Jumble Gym	ZZXX0430	28' 8" x 26' 6" (8,75m x 8,07m)	6' 1" (1,85m)	12	6	354 lbs (161 kg)	•	•	•	•	•	\$6,889
Cosmic Warp	ZZXX0401	24' 6" x 14' 6" (7,47m x 4,42m)	8' 9" (2,67m)	6	2	251 lbs (114 kg)	•	•	•	•	•	\$3,175
Super Dome	ZZXX0400	27' 6" x 27' 6" (8,38m x 8,38m)	6' 2" (1,88m)	15	10	358 lbs (163 kg)	•	•	•	•	•	\$5,975
Moon Rock Climber	ZZXX0148	18' 4" x 21' 2" (5,59m x 6,45m)	3' 8" (1,12m)	8	4	243 lbs (111 kg)	•	•	•	•	•	\$4,369
Whirlwind Climbers 2' (0,61m)	ZZUN6736	14' 0" x 15' 3" (4,27m x 4,66m)	2' 0" (0,61m)	2	2	114 lbs (52 kg)	•	•	•	•	•	\$1,825
Whirlwind Climbers 3' (0,91m)	ZZUN6737	14' 0" x 15' 3" (4,27m x 4,66m)	3' 0" (0,91m)	2	2	133 lbs (61 kg)	•	•	•	•	•	\$2,235
Whirlwind Climbers 4' (1,22m)	ZZUN6738	14' 0" x 15' 3" (4,27m x 4,66m)	4' 0" (1,22m)	2	2	152 lbs (69 kg)	•	•	•	•	•	\$2,645
Whirlwind Climbers 5' (1,52m)	ZZUN6739	14' 0" x 15' 3" (4,27m x 4,66m)	5' 0" (1,52m)	2	2	171 lbs (78 kg)	•	•	•	•	•	\$3,065
Whirlwind Climbers 6' (1,83m)	ZZUN6740	14' 0" x 15' 3" (4,27m x 4,66m)	6' 0" (1,83m)	2	3	190 lbs (87 kg)	•	•	•	•	•	\$3,685
Summit Climbers: Ozarks	ZZXX0461	33' 3" x 24' 6" (10,15m x 7,46m)	7' 11" (2,41m)	12	6	454 lbs (206 kg)	•	•	•	•	•	\$7,665
Summit Climbers: Sierra	ZZXX0462	29' 9" x 17' 10" (9,06m x 5,43m)	8' 7" (2,62m)	10	5	449 lbs (204 kg)	•	•	•	•	•	\$6,729
Summit Climbers: Rockies	ZZXX0463	33' 3" x 31' 10" (10,15m x 9,7m)	8' 7" (2,62m)	16	8	774 lbs (352 kg)	•	•	•	•	•	\$11,519
Summit Climbers: Appalachian	ZZXX0464	33' 3" x 33' 11" (10,15m x 10,33m)	8' 7" (2,62m)	22	13	1101 lbs (500 kg)	•	•	•	•	•	\$16,585

+CSA and EN compliant versions available.

All play equipment must be installed over an appropriate impact absorbing surface that complies with ASTM or CSA standards. See your Playworld representative for more information.



Adventure Canyon  
RB-1015 • AGES: 5-12



Rocky Ridge  
RB-1200 • AGES: 5-12



Climbing Tunnel  
ZZXX0407 • AGES: 2-12



Corner Rock  
RB-305 • AGES: 5-12



Around the Bend  
RB-310 • AGES: 5-12



Hairpin Turn  
RB-315 • AGES: 5-12



WonderFalls  
RB-1005 • AGES: 5-12

PRODUCT	ITEM	SPACE REQUIRED	FALL HEIGHT	USERS	INSTALL HOURS	WEIGHT	ADA	ASTM F1487	CPSC PUB.325	CAN/CSA Z614	EN1176	APPROX. PRICE
RockBlocks® Adventure Canyon	RB-1015	36' 5" x 29' 5" (11,1m x 8,97m)	9' 0" (2,74m)	26	20	1414 lbs (642 kg)	•	•	•	+		\$32,229
RockBlocks® Rocky Ridge	RB-1200	33' 5" x 16' 7" (10,19m x 5,05m)	8' 0" (2,44m)	10	7	459 lbs (209 kg)	•	•	•	•		\$11,255
RockBlocks® Climbing Tunnel	ZZXX0407	21' 0" x 19' 0" (6,4m x 5,79m)	3' 3" (0,99m)	6	4	321 lbs (146 kg)	•	•	•	•		\$6,605
RockBlocks® Corner Rock	RB-305	19' 10" x 17' 2" (6,04m x 5,23m)	5' 0" (1,52m)	8	5	298 lbs (136 kg)	•	•	•	•		\$6,395
RockBlocks® Around the Bend	RB-310	24' 9" x 19' 2" (7,54m x 5,84m)	7' 0" (2,13m)	12	6	493 lbs (224 kg)	•	•	•	•		\$11,131
RockBlocks® Hairpin Turn	RB-315	25' 3" x 23' 11" (7,7m x 7,29m)	7' 0" (2,13m)	19	10	813 lbs (369 kg)	•	•	•	•		\$18,354
RockBlocks® WonderFalls	RB-1005	23' 9" x 27' 1" (7,24m x 8,25m)	9' 0" (2,74m)	14	11	798 lbs (362 kg)	•	•	•	+		\$17,411



### Mount Vernon

ZZXX1326 • AGES: 5-12

### Salem

ZZXX1324 • AGES: 5-12

PRODUCT	ITEM	SPACE REQUIRED	FALL HEIGHT	USERS	INSTALL HOURS	WEIGHT	ADA	ASTM F1487	CAN/CSA Z614	APPROX. PRICE
Timber Stacks™ Mount Vernon	ZZXX1326	30' 10" x 26' 5" (9,39m x 8,05m)	7' 5" (2,26m)	22	46	3993 lbs (1811 kg)	•	•	•	\$38,135
Timber Stacks™ Salem	ZZXX1324	34' 4" x 30' 2" (10,45m x 9,2m)	8' 1" (2,47m)	23	44	3685 lbs (1672 kg)	•	•	•	\$38,135



**A. Olympia**

ZZXX1327 • AGES: 5-12

**B. Longview**

ZZXX1325 • AGES: 5-12

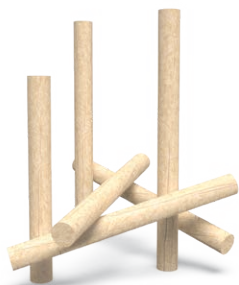

**Eugene**

ZZXX1320 • AGES: 5-12

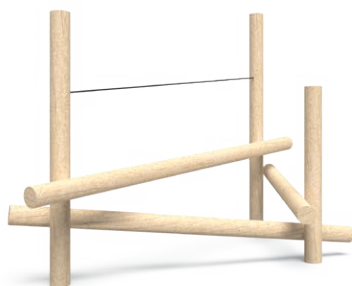

**Albany**

ZZXX1321 • AGES: 5-12

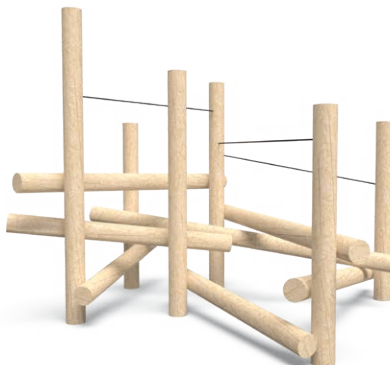

**Spokane**

ZZXX1323 • AGES: 5-12

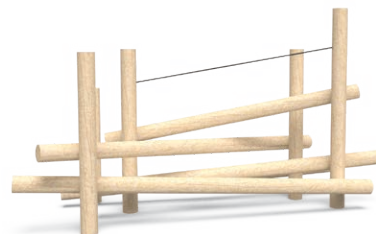

**Macon**

ZZXX1322 • AGES: 5-12

PRODUCT	ITEM	SPACE REQUIRED	FALL HEIGHT	USERS	INSTALL HOURS	WEIGHT	ADA	ASTM F1487	CPSA PUB.325	CAN./CSA Z614	APPROX. PRICE
A. Timber Stacks™ Olympia	ZZXX1327	61' 6" x 40' 4" (18,75m x 12,28m)	7' 1" (2,16m)	44	86	9075 lbs (4116 kg)	•	•	•	•	\$80,509
B. Timber Stacks™ Longview	ZZXX1325	37' 11" x 29' 8" (11,55m x 9,05m)	5' 10" (1,77m)	23	78	4538 lbs (2058 kg)	•	•	•	•	\$43,699
Timber Stacks™ Eugene	ZZXX1320	21' 2" x 19' 8" (6,46m x 6m)	3' 4" (1,01m)	6	15	798 lbs (362 kg)	•	•	•	•	\$8,515
Timber Stacks™ Albany	ZZXX1321	27' 1" x 10' 10" (8,26m x 3,29m)	5' 4" (1,62m)	6	17	1815 lbs (824 kg)	•	•	•	•	\$11,405
Timber Stacks™ Spokane	ZZXX1323	24' 11" x 26' 11" (7,59m x 8,2m)	6' 0" (1,83m)	14	44	2904 lbs (1317 kg)	•	•	•	•	\$24,245
Timber Stacks™ Macon	ZZXX1322	30' 10" x 18' 11" (9,39m x 5,76m)	6' 1" (1,86m)	10	27	2965 lbs (1345 kg)	•	•	•	•	\$17,819



## Boulders

Mimic an authentic rock climbing experience in a safe, durable way with these boulders. Made of PolyFiberCrete®, these products look and feel like the real deal while providing a non-slip surface for kids to practice climbing, coordination, and agility.

### A. Ridge Boulder

ZZBD0015 • AGES: 5-12

- A platform at the top rewards climbers with a thrilling view and place to hang out
- Handholds and footholds guide climbers up and around
- Unique angles encourage safe risk-taking

### B. Castle Boulder

ZZBD0016 • AGES: 5-12

- Our tallest boulder puts kids' problem-solving skills to the test
- Challenging routes offer more adventure for bigger kids
- Creative angles and crevices appeal to younger climbers

### C. Picnic Boulder

ZZBD0013 • AGES: 2-12

- The wide, flat top surface is great for hanging out with friends
- Built-in cave allows for easy wheelchair access
- Ability to connect to your playground

TOP INCLUSIVE PRODUCT

### D. Tower Boulder

ZZBD0014 • AGES: 5-12

- Simple routes provide an easy climb to the top
- Built-in cave makes for fun exploration on the ground
- Ability to connect to your playground

### E. Bench Boulder

ZZBD0012 • AGES: 2-12

- Great for all skill levels
- Easy-to-climb activity for younger children
- Natural alternative to commercial seating

PRODUCT	ITEM	SPACE REQUIRED	FALL HEIGHT	USERS	INSTALL HOURS	WEIGHT	ADA	ASTM F1487	CPSA PUB.225	CAV/CSA Z614	EN1176	APPROX. PRICE
A. Ridge Boulder	ZZBD0015	19' 5" x 17' 2" (5,92m x 5,23m)	6' 0" (1,83m)	4	2	7830 lbs (3551 kg)	•	•	•	•	•	\$23,889
B. Castle Boulder	ZZBD0016	20' 8" x 16' 8" (6,3m x 5,08m)	7' 9" (2,36m)	5	2	13920 lbs (6313 kg)	•	•	•	•	•	\$35,905
C. Picnic Boulder	ZZBD0013	20' 11" x 16' 8" (6,38m x 5,08m)	3' 0" (0,91m)	5	2	3600 lbs (1633 kg)	•	•	•	•	•	\$9,815
D. Tower Boulder	ZZBD0014	17' 4" x 16' 1" (5,28m x 4,9m)	6' 1" (1,85m)	4	2	4640 lbs (2105 kg)	•	•	•	•	•	\$16,785
E. Bench Boulder	ZZBD0012	15' 3" x 14' 5" (4,65m x 4,4m)	1' 8" (0,51m)	3	2	1160 lbs (527 kg)	•	•	•	•	•	\$2,809





## Boulder Ropes

For added thrill and challenge, add any one of these ropes between two boulders. Boulders sold separately.



### Tight Rope

AGES: 5-12

- The gripping adventure builds dexterity and upper-body strength
- Attaches to Ridge, Tower, and Castle Boulders



### Mod X Climber

AGES: 5-12

- Add a lateral climb for kids who want a bigger challenge
- Encourages balance, coordination, and strength
- Attaches to Ridge, Tower, and Castle Boulders



### Rope Bridge

AGES: 5-12

- Develops balance and coordination, and promotes pretend play
- Base rope available only in natural color as shown
- Available on Ridge, Tower, and Castle Boulders



### Nature-Inspired Log and Stone Pillars

AGES: 2-12

- Color and texture of real wood or stone facilitates imagination and awakens sensory skills
- Use as freestanding stepper, independently or with other pillars to access a deck
- Available in 12" (0,30m), 18" (0,46m), and 24" (0,61m) heights
- Each pillar sold separately

### Log Crawl

ZZUN8807 • AGES: 2-12

- Provides a cozy spot for hiding, relaxing, socializing, and imagining
- Made of glass fiber reinforced concrete (GFRC) for durability and easy maintenance



### Pup Tent Climber

ZZXX0409 • AGES: 2-12

- Ample space beneath provides a place for quiet time, hiding, or socialization
- Exterior of the tent features several RockBlocks™ handholds that allow for climbing
- Encourages imaginative and social play

### Log Hop

ZZUN8396 • AGES: 2-12

- Create an imaginative path through the swamp
- Available in 12" (0,30m) and 16" (0,41m) heights
- Sold individually

### Rock Log

ZZBD0027 • AGES: 2-12

- The flex-design lets you turn it into a balance beam, a bridge, or a bench
- Promotes fitness and social play: kids can sit, walk, climb, and jump into a new adventure
- Looks like a real wood log, but without the maintenance worries of one

PRODUCT	ITEM	SPACE REQUIRED	FALL HEIGHT	USERS	INSTALL HOURS	WEIGHT	ADA	ASTM F1487	CPSC PUB.325	CAN/CSA Z614	EN1176	APPROX. PRICE
Log Pillar 24" (0,61m)	ZZUN8803	13' 0" x 13' 0" (3,96m x 3,96m)	2' 0" (0,61m)	1	2	182 lbs (83 kg)	•	•	•	•	•	\$2,049
Log Pillar 18" (0,46m)	ZZUN8802	13' 0" x 13' 0" (3,96m x 3,96m)	1' 6" (0,46m)	1	2	161 lbs (73 kg)	•	•	•	•	•	\$1,369
Log Pillar 12" (0,30m)	ZZUN8801	13' 0" x 13' 0" (3,96m x 3,96m)	1' 0" (0,3m)	1	2	141 lbs (64 kg)	•	•	•	•	•	\$1,369
Stone Pillar 24" (0,61m)	ZZUN8813	13' 0" x 13' 0" (3,96m x 3,96m)	2' 0" (0,61m)	1	2	182 lbs (83 kg)	•	•	•	•	•	\$2,059
Stone Pillar 18" (0,46m)	ZZUN8812	13' 0" x 13' 0" (3,96m x 3,96m)	1' 6" (0,46m)	1	2	161 lbs (73 kg)	•	•	•	•	•	\$1,375
Stone Pillar 12" (0,30m)	ZZUN8811	13' 0" x 13' 0" (3,96m x 3,96m)	1' 0" (0,3m)	1	2	141 lbs (64 kg)	•	•	•	•	•	\$1,369
Log Crawl	ZZUN8807	16' 1" x 14' 11" (4,9m x 4,55m)	2' 5" (0,74m)	8	2	1364 lbs (619 kg)	•	•	•	•	•	\$5,079
Pup Tent Climber	ZZXX0409	19' 0" x 15' 11" (5,79m x 4,85m)	4' 1" (1,24m)	6	5	320 lbs (146 kg)	•	•	•	•	•	\$5,225
Log Hop 12" (0,30m)	ZZUN8396	13' 6" x 13' 6" (4,11m x 4,11m)	1' 0" (0,3m)	1	1	51 lbs (24 kg)	•	•	•	•	•	\$539
Log Hop 16" (0,41m)	ZZUN8428	13' 6" x 13' 6" (4,11m x 4,11m)	1' 4" (0,41m)	1	1	54 lbs (25 kg)	•	•	•	•	•	\$565
Rock Log	ZZBD0027	21' 6" x 15' 11" (6,55m x 4,85m)	2' 7" (0,79m)	5	2	3300 lbs (1497 kg)	•	•	•	•	•	\$11,255

+CSA and EN compliant versions available.

All play equipment must be installed over an appropriate impact absorbing surface that complies with ASTM or CSA standards. See your Playworld representative for more information.



**T-Rex Head**

ZZXX0135 • AGES: 2-12

**T-Rex Ribs**

ZZXX0136 • AGES: 2-12

**T-Rex Tail**

ZZXX0137 • AGES: 2-12



**T-Rex Hatchling Egg**

ZZXX0139 • AGES: 2-12

**T-Rex Hatched Egg**

ZZXX0138 • AGES: 2-12



**Fossil Jam**

ZZXX0061 • AGES: 2-12



**A. Raptor Rock Tail**

ZZXX0060 • AGES: 2-12

**B. Raptor Rock Head**

ZZXX0059 • AGES: 2-12

PRODUCT	ITEM	SPACE REQUIRED	FALL HEIGHT	USERS	INSTALL HOURS	WEIGHT	ADA	ASTM F1487	CPSC PUB.225	CAN./CSA Z614	EN1176	APPROX. PRICE
T-Rex Head	ZZXX0135	17' 3" x 14' 10" (5,26m x 4,52m)	4' 2" (1,27m)	5	1	2500 lbs (1134 kg)	•	•	•	•	•	\$10,219
T-Rex Ribs	ZZXX0136	19' 8" x 16' 11" (6m x 5,16m)	5' 6" (1,68m)	9	1	2750 lbs (1248 kg)	•	•	•	•	•	\$18,645
T-Rex Tail	ZZXX0137	18' 5" x 16' 3" (5,61m x 4,95m)	3' 9" (1,14m)	5	1	1325 lbs (601 kg)	•	•	•	•	•	\$7,329
T-Rex Hatchling Egg	ZZXX0139	15' 10" x 15' 9" (4,82m x 4,8m)	4' 7" (1,4m)	3	1	2860 lbs (1298 kg)	•	•	•	•	•	\$6,539
T-Rex Hatched Egg	ZZXX0138	16' 7" x 15' 4" (5,05m x 4,67m)	3' 7" (1,09m)	3	1	1500 lbs (681 kg)	•	•	•	•	•	\$5,635
Fossil Jam	ZZXX0061	-	-	4	1	121 lbs (55 kg)	•	•	•	•	•	\$909
A. Raptor Rock Tail	ZZXX0060	-	-	5	1	410 lbs (186 kg)	•	•	•	•	•	\$1,339
B. Raptor Rock Head	ZZXX0059	-	-	5	1	429 lbs (195 kg)	•	•	•	•	•	\$1,339



Custom design and paint (as shown here) is available for all Sculpted Play Elements.

Our sculpted play elements are made of GFRP (glass fiber reinforced polymer), which makes them lighter in weight and easier to install than concrete. GFRP is durable, UV-stable, and fade resistant. With vibrant colors and whimsical details, these elements provide a rich sensory experience and provide you with the opportunity to pack a lot of play value into an imaginative package.



**Black Bear Tunnel Climber**  
ZZTP2154M • AGES: 2-12



**Gorilla Tunnel Climber**  
ZZTP2182M • AGES: 2-12



**Ladybug Climber**  
ZZTP2036M • AGES: 6MOS-12YRS



**Bunny Climber**  
ZZTP2104M • AGES: 6MOS-12YRS



**Whale Climber**  
ZZTP2121M • AGES: 2-12,



**Whale Tail Climber**  
ZZTP2026M • AGES: 2-12



**Hammerhead Shark Climber**  
ZZTP2138M • AGES: 2-12



**Coral Reef Climber**  
ZZTP2037M • AGES: 2-12

PRODUCT	ITEM	SPACE REQUIRED	FALL HEIGHT	USERS	INSTALL HOURS	WEIGHT	ADA	ASTM F1487	CPSC PUB 325	ICAN/CSA Z614	EN176	APPROX. PRICE
Black Bear Tunnel Climber	ZZTP2154M	19' 2" x 16' 2" (5,85m x 4,94m)	3' 8" (1,13m)	5	3	367 lbs (167 kg)	•	•	•	•	•	\$13,008
Gorilla Tunnel Climber	ZZTP2182M	15' 10" x 16' 4" (4,82m x 4,98m)	3' 11" (1,19m)	4	3	280 lbs (127 kg)	•	•	•	•	•	\$12,379
Ladybug Climber	ZZTP2036M	16' 0" x 14' 9" (4,88m x 4,5m)	1' 4" (0,4m)	3	2	120 lbs (55 kg)	•	•	•	•	•	\$4,944
Bunny Climber	ZZTP2104M	15' 0" x 13' 10" (4,57m x 4,22m)	1' 8" (0,52m)	3	2	105 lbs (48 kg)	•	•	•	•	•	\$3,629
Whale Climber	ZZTP2121M	20' 11" x 17' 2" (6,38m x 5,23m)	5' 0" (1,52m)	4	3	344 lbs (157 kg)	•	•	•	•	•	\$11,111
Whale Tail Climber	ZZTP2026M	10' 0" x 17' 0" (3,05m x 5,18m)	2' 6" (0,76m)	3	3	243 lbs (111 kg)	•	•	•	•	•	\$6,579
Hammerhead Shark Climber	ZZTP2138M	18' 10" x 13' 0" (5,74m x 3,96m)	3' 0" (0,91m)	4	3	230 lbs (105 kg)	•	•	•	•	•	\$7,789
Coral Reef Climber	ZZTP2037M	23' 1" x 16' 8" (7,03m x 5,08m)	5' 0" (1,52m)	5	3	402 lbs (183 kg)	•	•	•	•	•	\$15,817



**Lumberjack Hollow Tunnel Climber**  
ZZTP2139M • AGES: 2-12



**Mushroom Path Stepper**  
ZZTP2023M • AGES: 5-12



**Gator Climber**  
ZZTP2017M • AGES: 2-12



**Ladybug Hill Tunnel Climber**  
ZZTP2008M • AGES: 2-12



**Blue Butterfly Climber**  
ZZTP2022M • AGES: 2-12



**Inchworm Climber**  
ZZTP2030M • AGES: 2-12



**Pufferfish Tunnel Climber**  
ZZTP2443M • AGES: 2-12



**Frog Climber**  
ZZTP2021M • AGES: 2-12



**Tucson Turtle Climber**  
ZZTP2020M • AGES: 2-12



**Tree Log Climber**  
ZZTP2142M • AGES: 2-12



**Log Steps Climber**  
ZZTP2143M • AGES: 2-12



**Jungle Rock Climber**  
ZZTP2134M • AGES: 2-12



**Jungle Rock Link**  
ZZTP2018M • AGES: 2-12

PRODUCT	ITEM	SPACE REQUIRED	FALL HEIGHT	USERS	INSTALL HOURS	WEIGHT	ADA	ASTM F1487	CPSC 1512	EN1176	APPROX. PRICE
Lumberjack Hollow Tunnel Climber	ZZTP2139M	18' 0" x 15' 10" (5,49m x 4,82m)	2' 6" (0,76m)	4	3	253 lbs (115 kg)	•	•	•	•	\$10,855
Mushroom Path Stepper	ZZTP2023M	19' 0" x 16' 8" (5,79m x 5,09m)	2' 6" (0,76m)	3	3	161 lbs (73 kg)	•	•	•	•	\$9,331
Gator Climber	ZZTP2017M	20' 8" x 15' 2" (6,31m x 4,63m)	1' 8" (0,52m)	5	2	109 lbs (50 kg)	•	•	•	•	\$7,472
Ladybug Hill Tunnel Climber	ZZTP2008M	17' 11" x 16' 11" (5,46m x 5,15m)	1' 10" (0,55m)	4	3	167 lbs (76 kg)	•	•	•	•	\$8,079
Blue Butterfly Climber	ZZTP2022M	16' 7" x 18' 1" (5,06m x 5,52m)	3' 6" (1,07m)	4	3	178 lbs (81 kg)	•	•	•	•	\$8,708
Inchworm Climber	ZZTP2030M	18' 0" x 13' 8" (5,49m x 4,18m)	2' 10" (0,85m)	4	2	106 lbs (48 kg)	•	•	•	•	\$6,333
Pufferfish Tunnel Climber	ZZTP2443M	18' 6" x 15' 10" (5,64m x 4,82m)	3' 6" (1,07m)	4	3	238 lbs (108 kg)	•	•	•	•	\$7,953
Frog Climber	ZZTP2021M	17' 7" x 16' 2" (5,36m x 4,94m)	3' 0" (0,91m)	4	3	183 lbs (83 kg)	•	•	•	•	\$8,871
Tucson Turtle Climber	ZZTP2020M	18' 1" x 16' 7" (5,52m x 5,06m)	1' 10" (0,55m)	4	3	193 lbs (88 kg)	•	•	•	•	\$7,585
Tree Log Climber	ZZTP2142M	18' 10" x 14' 4" (5,74m x 4,37m)	3' 4" (1,01m)	4	2	192 lbs (88 kg)	•	•	•	•	\$6,538
Log Steps Climber	ZZTP2143M	20' 0" x 16' 7" (6,1m x 5,05m)	5' 0" (1,52m)	4	5	316 lbs (144 kg)	•	•	•	•	\$9,738
Jungle Rock Climber	ZZTP2134M	23' 0" x 16' 8" (7,01m x 5,08m)	5' 0" (1,52m)	5	3	512 lbs (233 kg)	•	•	•	•	\$15,090
Jungle Rock Link	ZZTP2018M	20' 4" x 16' 8" (6,2m x 5,08m)	5' 0" (1,52m)	4	3	385 lbs (175 kg)	•	•	•	•	\$13,882



## Complete 5-Station System

ENERGI-PR-500-SM

- Features all 5 stations and the welcome sign

Fitness is a form of play for many—an integral reason we developed ENERGI™, an outdoor fitness system that combines functional fitness with body-weight training.



PRODUCT	ITEM	AGES	SPACE REQUIRED	FALL HEIGHT	EVENTS	USERS	INSTALL HOURS	WEIGHT	ADA	ASTM F3101	EN16630	APPROX. PRICE
ENERGI® Complete 5-Station System	ENERGI-PR-500-SM	13+	46' 0" x 41' 0" (14,02m x 12,5m)	6' 6" (1,97m)	120	20	13	1315 lbs (597 kg)	•			\$28,170



## Fitness & Wellness Systems

It's time to build up our communities—to create spaces where we can motivate each other to get fit and stay well. Our outdoor fitness equipment brings family-friendly exercise to the neighborhood.

156 **ENERGI®**

159 **Warm-up Equipment**

160 **LifeTrail®**

View ENERGI® videos at  
[Youtube.com/ENERGIFitness](https://www.youtube.com/ENERGIFitness)



**Station 1**  
**Static & Dynamic Stretches**

ZZXX0089S

- Features 24 stretching exercises that are a perfect beginning and ending to any exercise routine
- Gray platform has a textured, non-slip surface with colored targets for a safer, more dynamic exercise



**Station 2**  
**Pulling, Back, Angle Bar & Hurdle Exercises**

ZZXX0090S

- Features 24 exercises including the pull-up, chin-up, hurdle dip, and hurdle jump



**Station 3**  
**Squat, Dip, Push-Up & Balance Exercises**

ZZXX0091S

- Features 24 exercises including the squat, single-leg squat, V-sit, triceps dip, balance beam, and push-up
- Balance bar has a gray, textured, non-slip surface for safety



**Station 4**  
**Power & Agility Step Exercises**

ZZXX0092S

- Features 24 exercises including the step-up, lateral step-up, V-step, and A-step
- Platforms have a gray, textured, non-slip surface for safety



**Station 5**  
**Core, Torso & Balance Disc Exercises**

ZZXX0093S

- Features 24 exercises including the lunge, plank, sit-up, and reverse curl
- Balance disc features only three simple parts for added durability, and a gray, textured, non-slip surface for safety



**Welcome Sign**

ZZXX0117S

- Welcomes new users to ENERGI and features Fit Tips for all levels
- Available, for an additional fee, as a two-sided custom sign, with your own message and design on the second side. Ideal for promoting your facility or thanking a sponsor!

PRODUCT	ITEM	AGES	SPACE REQUIRED	FALL HEIGHT	EVENTS	USERS	INSTALL HOURS	WEIGHT	ADA	ASTM F2101	EN16630	APPROX. PRICE
ENERGI® Station 1	ZZXX0089S	13+	15' 8" x 18' 5" (4,78m x 5,61m)	0' 5" (0,13m)	24	4	3	390 lbs (177 kg)	•		•	\$6,595
ENERGI® Station 2	ZZXX0090S	13+	22' 4" x 22' 3" (6,81m x 6,78m)	6' 6" (1,97m)	24	7	3	303 lbs (138 kg)	•		•	\$5,339
ENERGI® Station 3	ZZXX0091S	13+	19' 11" x 22' 8" (6,07m x 6,91m)	2' 7" (0,78m)	24	5	3	228 lbs (104 kg)	•		•	\$4,669
ENERGI® Station 4	ZZXX0092S	13+	13' 9" x 14' 9" (4,19m x 4,5m)	1' 4" (0,4m)	24	2	2	172 lbs (78 kg)	•		•	\$4,429
ENERGI® Station 5	ZZXX0093S	13+	18' 0" x 23' 2" (5,49m x 7,06m)	1' 11" (0,57m)	24	2	2	180 lbs (82 kg)	•		+	\$5,409
ENERGI® Welcome Sign (Surf Mnt)	ZZXX0117S	13+	-	-	-	-	1	41 lbs (19 kg)	•		•	\$1,729





### Switch Glider

ZZXX0499

- Engage the lower body in a low-impact, ski-style workout
- Involves your abdomen, lower back, glutes, thighs, and calves
- Grab the handles on either side, keep your feet planted on the platforms, and swing your legs back and forth in a scissor/switching motion
- The gliding action gives you a workout similar to walking and jogging without the impact of your feet hitting the ground
- Alter the intensity from gentle to moderate by using body weight resistance (leaning forwards and backwards, or bending your knees)
- Color only available as shown



### The Twister

ZZXX0487

- Step up onto the disk, hold onto the bar, and twist your torso from side to side
- Stretches the lower back and oblique muscles



### Recumbent Bike

ZZXX0488

- Ergonomically friendly for lower back
- Natural reclining position targets muscles like glutes for better results



### Shoulder Slide

ZZXX0492

- Step into the "U", hold a slider in each hand, and slide from sides to front
- Range of motion depends on where you stand
- Turn around to work the back muscles



### Arm & Shoulder Circles

ZZXX0489

- Use the handles on the disks to turn them
- Rotate inwards or outwards to work the muscles in your shoulders and upper back

PRODUCT	ITEM	AGES	SPACE REQUIRED	FALL HEIGHT	EVENTS	USERS	INSTALL HOURS	WEIGHT	ADA	ASTM F3101	EN16630	APPROX. PRICE
Switch Glider	ZZXX0499	13+	9' 9" x 10' 7" (2,97m x 3,22m)	2' 3" (0,69m)	1	1	1	221 lbs (100 kg)	•		•	\$3,729
The Twister	ZZXX0487	13+	9' 9" x 12' 6" (2,97m x 3,81m)	-	2	2	3	91 lbs (41 kg)	•		•	\$3,025
Recumbent Bike	ZZXX0488	13+	9' 0" x 10' 0" (2,74m x 3,05m)	-	1	1	2	104 lbs (48 kg)	•		•	\$4,665
Shoulder Slide	ZZXX0492	13+	10' 10" x 10' 10" (3,3m x 3,3m)	-	1	1	3	71 lbs (32 kg)	•		•	\$2,349
Arm & Shoulder Circles	ZZXX0489	13+	10' 0" x 13' 7" (3,05m x 4,14m)	-	2	2	2	213 lbs (97 kg)	•		•	\$6,029



## LifeTrail®

Advanced Wellness System

Play is a basic human need for people of all ages. So how do we cater to the play needs of everyone? By creating low-impact wellness playgrounds that provide adults with varying physical abilities with opportunities for socialization, exercise, and fun!

View LifeTrail videos at  
[Youtube.com/LifeTrailAdvanced](https://www.youtube.com/LifeTrailAdvanced)

The LifeTrail Advanced Wellness System was designed in collaboration with a kinesiology and gerontology specialist to:

- Build and maintain flexibility, balance, and coordination skills required to perform everyday tasks
- Reduce falls and the risk of serious illnesses
- Boost emotional health—reducing feelings of isolation, tension, depression, and fatigue
- Strengthen cognitive skills and memory

# Easy-Order System Packages

## LifeTrail® 7 Stations

LAWS-700OR-SM

- Features 7 three-sided stations with roofs
- 3 activity panels per station (15 activity panels and 6 wheelchair-accessible activity panels)
- Multiple exercises per panel, 159 exercises in total

## LifeTrail® 5 Stations

LAWS-500OR-SM

- Features 5 three-sided stations, with roofs
- 3 activity panels per station (15 activity panels)
- Multiple exercises per panel, 113 exercises in total

## Recommended Stations

The following station arrangement is recommended for users to get the most out of every workout. You can also mix and match any of the 21 activity panels to create your own stations.

TOP VIEW	COMBINED STATION ACTIVITIES	SPACE REQUIRED	FALL HEIGHT	WEIGHT	INSTALL HOURS	APPROX. PRICE
	<b>Station 1 w/Roof</b> LAWS-1R-SM <ul style="list-style-type: none"> <li>• Welcome Sign</li> <li>• Lower-Body Cycling Exercises</li> <li>• PNF Exercises</li> </ul>	17' 0" x 16' 0" (5,18m x 4,88m)	2' 1" (0,63m)	446 lbs (203 kg)	3	\$11,378
	<b>Station 2 w/Roof</b> LAWS-2R-SM <ul style="list-style-type: none"> <li>• Hip Lift &amp; Thigh Squeeze Exercises</li> <li>• Push-Up Exercises</li> <li>• Wobble Board Exercises</li> </ul>	19' 8" x 19' 0" (6m x 5,79m)	5' 0" (1,52m)	443 lbs (201 kg)	3	\$8,438
	<b>Station 3 w/Roof</b> LAWS-3R-SM <ul style="list-style-type: none"> <li>• Upper-Body Cycling Exercises</li> <li>• Squat Exercises</li> <li>• Tricep Strength &amp; Torso Stability Exercises</li> </ul>	17' 6" x 17' 10" (5,33m x 5,43m)	2' 2" (0,66m)	354 lbs (161 kg)	3	\$9,646
	<b>Station 4 w/Roof</b> LAWS-4R-SM <ul style="list-style-type: none"> <li>• Inverted Row &amp; Core Exercises</li> <li>• Weighted Squat Exercises</li> <li>• Shoulder Stability &amp; Strength</li> </ul>	20' 6" x 15' 9" (6,25m x 4,8m)	4' 2" (1,27m)	560 lbs (254 kg)	4	\$11,542
	<b>Station 5 w/ Roof</b> LAWS-5R-SM <ul style="list-style-type: none"> <li>• Stair Exercises</li> <li>• Overhead Press Exercises</li> <li>• Standing Stretches &amp; Yoga Poses</li> </ul>	16' 6" x 20' 0" (5,03m x 6,1m)	2' 0" (0,61m)	696 lbs (316 kg)	5	\$12,624
	<b>Station 6 ADA w/ Roof</b> LAWS-6R-SM <ul style="list-style-type: none"> <li>• PNF &amp; Leg Extension Exercises (ADA)</li> <li>• Tricep Strength &amp; Torso Stability Exercises (ADA)</li> <li>• Upper-Body Cycling Exercises (ADA)</li> </ul>	15' 6" x 16' 6" (4,72m x 5,03m)	3' 0" (0,91m)	317 lbs (144 kg)	3	\$8,772
	<b>Station 7 ADA w/ Roof</b> LAWS-7R-SM <ul style="list-style-type: none"> <li>• Overhead Press Exercises</li> <li>• Stretch Exercises (ADA)</li> <li>• Shoulder Stability &amp; Strength (ADA)</li> </ul>	17' 6" x 16' 4" (5,33m x 4,98m)	-	463 lbs (210 kg)	4	\$9,508





## Site Amenities

A trip to the playground is much more enjoyable when you have all the necessary comforts. Shade, benches, picnic tables, grills—even the smallest amenities enhance the experience.

Playgrounds are a big investment, and you deserve the best value for your dollar! Our site amenities ensure a quality experience for all visitors over the years to come.

**FOR MORE INFORMATION, VISIT:  
PLAYWORLD.COM/SITEAMENITIES**



#### Bench

- Curved edges for contemporary aesthetic
- 6' (1,83m) or 8' (2,44m) fixed lengths
- Portable, in-ground, or surface-mounted available



#### Rectangle Table

- Rectangular shaped table
- Two long benches connected to each side
- 6' (1,83m) or 8' (2,44m) lengths



## Shade

- Blocks up to 96% of the sun's UV rays
- Keeps playground up to 20 degrees cooler
- Designed to withstand nominal wind loads of 90 mph (144,84 kph) with appropriate footing.
- To extend the life of shade, the shade must be removed for winter in snowy regions
- Requires little to no maintenance
- One-piece fabric design for maximum coverage
- Canopies available in 2 sizes – 16' (4,88m) and 20' (6,1m)
- Hypar shade features catenary design system that suspends the fabric away from any structural material that may abrade the fabric
- Choice of one fabric color and one paint color (fabric colors on page 205)



## Covered Grill

- 500 square inches of cooking space
- Fixed cooking grates can be tilted for easy cleaning
- Pedestal mounts permanently in-ground



## Traditional Receptacle

- 32-gallon capacity
- Lid and liner sold separately
- In-ground and surface mount post sold separately



## Trash Dome Top

- Fits 32-gallon receptacles
- Made of high-density polyethylene (HDPE)
- Available in black, blue, brown, gray (shown), green and red







## Components

Put your own spin on the playground—literally. Components let you choose the perfect activities for your play structure, whether it's climbing, sliding, or just hanging out.

- 168 Motion Play**
- 171 Slides**
- 174 Climbers**
- 186 Upper Body Activities**
- 187 Connectors**
- 188 Bridges**
- 189 Tubes**
- 190 Themed Panels**
- 192 Skill & Sensory Panels**
- 196 Activity Panels**
- 197 Puzzle Inserts**
- 198 Enclosures & Extras**
- 200 Roofs & Toppers**



**AeroGlider™** AGES: 2-12

Encourages cooperation & teamwork among children

**Exterior:**

- Sleek, aerodynamic design with customizable "license plates"
- Unique step platform on both ends for more play and swaying fun
- Back high rails allow adults to help glide and participate in the fun

**Interior:**

- Full 5' (1,52m) wheelchair turning radius
- Enough room for two wheelchair users to sit side-by-side
- Couches on each end for children and adults to enjoy the ride



**TOP INCLUSIVE PRODUCT**



**Sky Rail** AGES: 5-12

- Exhilarating track ride
- Curved track designed to help give kids a head start
- Sturdy plastic handle allows for a firm grip
- Handle swivels to provide a more challenging ride



**Vortex** AGES: 5-12

- Fun comes full circle while kids stand and spin for a vigorous ride



**Monorail** AGES: 5-12

- Patented air brakes for a smooth, safe stop
- Cantilever posts clear path for a fluid ride from start to stop
- Available in 10' (3,05m) and 20' (6,10m, shown) lengths



**Bouncing Drawbridge** AGES: 5-12

- Add motion to your themed playground
- Bounces up and down but will not catapult like a springboard
- Available in Challengers® only



**Walk the Plank** AGES: 5-12

- Kids will stand in line to walk the plank!
- Bounces up and down but will not catapult like a springboard
- Available in Challengers® only



**Drop Zone Tower™** AGES: 5-12

- Step onto the platform to safely drop to the ground, where kids step off and watch it ascend to its original position
- Kids will run back up to take a ride over and over again
- Creates a new level of fun from a 4' (1,22m) or 6' (1,83m) deck



**Sidewalk** AGES: 2-12

- Sections move based on child's weight
- Develops sense of balance, coordination, and motor skills



**U-Bounce** AGES: 2-12

- Kids can bounce either seated or standing
- Slip-resistant, shock-absorbing rubber platform for safety



**Spin Central** AGES: 5-12

- Kids grab hold above and use their upper bodies to make crazy twists and turns



**Bounce Button** AGES: 5-12

- Range of motion determined by user's weight



**Critter Crossing™** AGES: 2-12

- Pivoting beam helps develop balance and leg strength



**Nuvo™ 360° Spiral Slide** AGES: 2-12

- Corkscrew slide features a one-piece bedway and canopy with molded-in handholds
- Graceful curves and swirls match Nuvo style
- Attaches to 4' (1,22m), 5' (1,52m), and 6' (1,83m) decks



**Nuvo™ Double Glide Slide** AGES: 2-12

- Each bedway offers a different sliding experience
- Exit areas flare out to provide more room
- Graceful curves and swirls match Nuvo style
- Attaches to a 3' (0,91m) deck



**90° Glide Slide** AGES: 2-12

- Sliding fun all kids will enjoy
- Features a 90° angle
- Attaches to 3' (0,91m) decks



Tube Slide w/ window

**Tube Slide** AGES: 2-12

- Segmented for design flexibility
- Choose from an endless variety of configurations
- Straight sections also allow for the addition of clear, durable windows facing skyward, allowing light inside tube and assisting supervision
- From 2' (0,61m) to 9' (2,74m) decks



**Slither Slide with Slide-a-Side**

AGES: 2-12

- Specially engineered to provide a place to sit while waiting for a mobility device or caregiver to return for assistance
- Designed to be a comfortable resting area for anyone needing extra time
- From 2' (0,61m) to 9' (2,74m) decks

**TOP INCLUSIVE PRODUCT**



Nautical Sea Serpent Theme

Castle Dragon Theme

**Themed Spiral Slide** AGES: 2-12

- Kids' imaginations will soar on this slide, available in Nautical Sea Serpent and Castle Dragon versions
- Attaches to 4' (1,22m), 5' (1,52m), and 6' (1,83m) decks
- Available in Challengers' only



**Twist and Shout Slide** AGES: 2-12

- Curved, textured bedways give a thrilling side-to-side motion
- Deck height is 4' (1,22m)



**Slither Slide** AGES: 2-12

- Segmented for design flexibility; choose from hundreds of configurations
- Each section of the Slither Slide features a slight bump in the bedway, creating a fun slide down
- From 2' (0,61m) to 9' (2,74m) decks



**Wide Glide Slide** AGES: 2-12

- 2'6" (0,76m) wide slide builds a sense of discovery
- Attaches to a 3' (0,91m) deck



**Zig Zag Slide** AGES: 2-12

- Features a zig-zag pattern
- Attaches to a 5' (1,52m) deck



**Roller Slither Slide** AGES: 2-12

- Inclusive slide offers a full-body, tactile experience for children who are hypo-sensitive to touch
- Super-durable aluminum rollers make a fun sound that provides auditory and proprioceptive stimulation for children of all abilities
- Add roller sections to any Slither Slide configuration for endless possibilities
- From 3' (0,91m) to 9' (2,74m) decks



**Glide Slide** AGES: 2-12

- Straight design for a smooth ride
- From 2' (0,61m) to 6' (1,83m) decks



**Mighty Descent w/ Prism Pass**  
AGES: 2-12

- Multiple children can enjoy sliding together on this 8-foot, extra-wide slide
- Prism Pass utilizes the space under Mighty Descent by providing a colorful maze full of bright panels that encourage social and imaginative play
- Available without Prism Pass and as a hillside version



**Themed Slither Slide** AGES: 2-12

- The flexibility of a Slither Slide with a themed facade, perfect for imaginations of any size!
- From 2' (0,61m) to 9' (2,74m) decks
- Available in Challengers' only

**TOP INCLUSIVE PRODUCT**

Under slide climber options also available



Curved Steel Climber



Spine Climber



Infill Barrier



### Tripple Racer Slide™ AGES: 2-12

- Features three slide heights accessible from one deck [one slide bedway at 4' (1,22m), 5'3" (1,60m), and 6'5" (1,98m) heights]
- Attaches to a 4' (1,22m) deck



### Rumble Seat Slide AGES: 2-12

- Bumpy slide helps build multi-sensory awareness
- Deck height is 5' (1,52m)



### Sliding Pole AGES: 5-12

- Classic fireman's pole slider
- From 3' (0,91m) to 6' (1,83m) decks

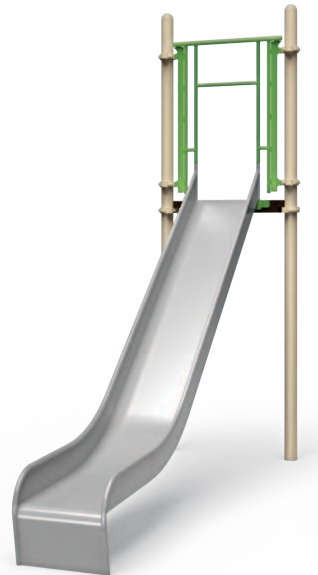

### Stainless Steel Slide AGES: 2-12

- One-piece, 14-gauge stainless steel
- Built "park tough" for longevity
- Attaches to 3' (0,91m), 4' (1,22m), 5' (1,52m), 6' (1,83m), and 8' (2,44m) decks



### 360° Stainless Steel Spiral Slide AGES: 2-12

- 16 gauge stainless steel with a mill finish
- Deck height 6' 3" (1,93m)

TOP INCLUSIVE PRODUCT

TOP INCLUSIVE PRODUCT

Branch Out provides a striking focal element for the playground, suggesting a tree and vines. Like trees, Branch Out gives opportunities for climbing, swaying, jumping, relaxing, and more!

Branch Out Anchors offer even more play value with exciting challenges that complete your play space with a consistent aesthetic.



Adventure Grove • 500-1951 • AGES: 5-12

For more Branch Out™ see pages 70-73.

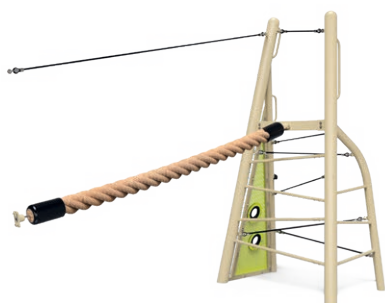

Anchor AGES: 5-12



Rope Bridge Connector AGES: 5-12



Gateway AGES: 5-12





Trunk w/Perf Metal Shade  
AGES: 5-12



Trunk w/Fabric Canopy  
AGES: 5-12

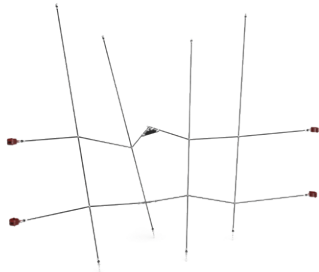

Zig-Zag AGES: 5-12

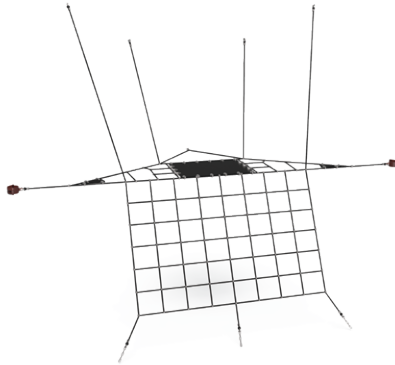

Cargo Net AGES: 5-12

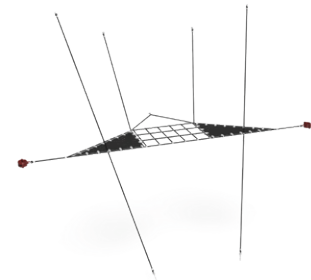

Hammock AGES: 5-12



Belt Connector AGES: 5-12



Pedestal AGES: 5-12



Twisted Net Connector AGES: 5-12

Inspired by nature, ModPods were designed to be more challenging than a flat plane climber. Modularity gives ModPods flexibility for virtually endless design possibilities that support social and inclusive play. ModPod forms can be freestanding, or they can be linked together to create ground-to-deck, deck-to-deck, and ground-to-activity configurations.



Quad Vertical AGES: 5-12



Tri-TableTop AGES: 5-12



Tri-Vertical Short AGES: 5-12



Tri-Vertical Tall AGES: 5-12



Quad Tabletop AGES: 5-12



Tri-Tabletop Low AGES: 2-5



Quad Tabletop Low AGES: 2-5

For more ModPods™ see pages 105, 144.



**Zig Zag Slide** AGES: 5-12

- Designed to simulate a waterfall with molded ridges in “waves” throughout the slide
- Smooth, rounded edges allow children to control their speed
- Shown with RockBlocks® Arch with Deck



**Diagonal Climber** AGES: 5-12

- Creates a unique way to access RockBlocks®
- Handles at the top allow for easy transition from climber to deck
- Shown with RockBlocks® Arch with Deck



**Hoops Climber** AGES: 5-12

- Hoops form an arch for a unique and challenging climb
- Handles at the top allow for easy transition from climber to deck
- Shown with RockBlocks® Arch with Deck



**Stalagmites** AGES: 5-12

- Kids will love the height and 360° of climbing space
- Connects to 2' (0,61m), 3' (0,91m), and 4' (1,22m) decks
- Add one or multiple Stalagmites to your playground



**Curved Wall** AGES: 5-12

- 90° curved wall slopes from 7' (2,13m) to 5' (1,52m) high
- Available with walk through (shown) or pass through



**Straight Wall** AGES: 5-12

- 7' (2,13m) tall wall can be flipped end-for-end or upside down



**End Wall** AGES: 5-12

- Perfect end piece for your RockBlocks® playground
- Features climbing and perching spots
- Available in 5' (1,52m) and 7' (2,13m) tall versions



**Tri-Ladder** AGES: 5-12

- Round ladder connects three walls
- Available in 5' (1,52m) and 7' (2,13m) heights



**90° Wall** AGES: 5-12

- 5' (1,52m) tall wall features a 90° curve at one end



## Nature-Inspired Components

Features have natural colors, shapes, sizes, and textures to complete your nature-themed play space. They're made of glass fiber reinforced concrete (GFRC), which is ultra-durable, low-maintenance, and lighter weight.



### Bedrock Transfer AGES: 2-12

- Molded-in handholds assist children of all abilities in climbing
- Accessible stone platform with transfer height of 15" (0,38m)
- Stone is physically connected to the transfer stairs



### Wood Pile AGES: 5-12

- Children can scale the fresh cut logs and pretend they're entering a tree house
- Gradual steps facilitate a 3-point climbing stance
- Place next to a structure to access a 5' (1,52m) deck



### Little Ridge AGES: 5-12

- Layered rock appearance and molded-in fossils enhance natural quality
- Undefined paths with multiple handholds offer a challenging climb
- Rotate to access multiple decks at different heights (4' [1,22m], 5' [1,52m], 6' [1,83m])



### Log Pillar AGES: 2-12

- Color and texture of real wood facilitates imagination and awakens sensory skills
- Use as freestanding stepper, independently, or with other pillars to access a deck
- Available in 12" (0,30m), 18" (0,46m), and 24" (0,61m) heights
- Each pillar sold separately



### Stone Pillar AGES: 2-12

- Color and texture of natural stone provides a rock climber's experience
- Use as freestanding stepper, independently, or with other pillars to access a deck
- Available in 12" (0,30m), 18" (0,46m), and 24" (0,61m) heights
- Each pillar sold separately



### Stump Climber AGES: 5-12

- Four connected "wood" stumps of varying height
- Non-linear climbing route provides challenge and opportunity to practice balance
- Place next to a structure to access a 4' (1,22m) deck



### Oak Trunk AGES: 5-12

- Kids can pretend to be woodland creatures as they scurry up this tree trunk
- Undefined paths with multiple handholds offer a challenging climb
- Rotate to access multiple decks at different heights (3' [0,91m], 4' [1,22m], 5' [1,52m], 6' [1,83m])

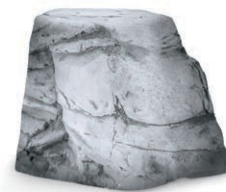

### Boulder Climber AGES: 5-12

- Littlest boulder has defined steps for beginning climbers
- Place next to a structure to access a 3' (0,91m) deck



**Wildwood Climber** AGES: 5-12

- Children will imagine they are climbing the roots of a giant tree or hiding beneath the roots
- Fun molded details include insects and knots, which broaden the opportunity for imaginative play
- Attaches to 4' (1,22m) and 5' (1,52m) decks



**Tree House Climber** AGES: 2-12

- Inspires kids to pretend they're climbing to their own tree house
- Allows for ground-to-deck access from 4' (1,22m) to 8' (2,44m)



**PlayWood™ Climber** AGES: 5-12

- Rustic look enhances nature theme adventures
- Attaches to 4' (1,22m), 5' (1,52m), and 6' (1,83m) decks



**Vine Climber** AGES: 5-12

- Children will feel like they are climbing through a thick forest of trees or making their way up a tangle of vines
- Adds tremendous visual appeal to the playground while enhancing the nature theme
- Connects deck-to-deck spanning 6' (1,83m)



**Castle Wall Climber** AGES: 5-12

- Scale the walls and save the princess, or make a daring escape
- Handholds allow for easy climbing
- Attaches to 6' (1,83m) deck
- Available for Challengers' only



**Bow Climber** AGES: 5-12

- Steer your ship through uncharted waters at the captain's wheel
- Look for land with the telescope and chart your course with the navigation map
- Attaches to 3' (0,92m) and 4' (1,22m) decks
- Also available in a version for 2- to 5-year-olds with steel climber
- Available in Challengers' only



**Stern Climber** AGES: 5-12

- Complete the look of your ship with this functional and imaginative climber
- Attaches to a 4' (1,22m) deck
- Also available in a version for 2- to 5-year-olds as a balcony
- Available in Challengers' only



**Whirlwind Climbers** AGES: 5-12

- Use one or multiple climbers for ground-to-deck access or to connect decks of various heights
- Available for 2' (0,61m), 3' (0,91m), 4' (1,22m), 5' (1,52m), and 6' (1,83m) decks



**Climbing Squares** AGES: 2-12

- Block climber sized just right for tots
- Allows kids to easily assume a 3-point climbing stance to ensure balance and a safer climb
- Treads on blocks help prevent slips
- Recessed areas help little hands and feet climb
- Available to 2' (0,61m), 3' (0,91m), and 4' (1,22m) decks



**Accessible Climber** AGES: 2-12

- User-friendly plastic treads
- Facilitates an accessible route to higher elevations



**Rock Climber** AGES: 2-12

- Fossil-matching activities on the underside promote gross motor skills
- Connects to 4' (1,22m) decks



**Rocky Ridge Climber** AGES: 5-12

- Attaches to 5' (1,52m) decks



**Steel Curve Climber** AGES: 2-12

- Curved steel climber provides easy access to 4' (1,22m) decks
- Add underneath your Tripple Racer Slide™ for even more fun



**Inclined Cliff Hanger®** AGES: 2-12

- Encourages safe risk taking
- Attaches to 4' (1,22m) up to 8' (2,44m) decks



**Solar Climber** AGES: 2-12

- Attaches to 2' (0,61m, Challengers® only), 3' (0,91m), 4' (1,22m), 5' (1,52m), and 6' (1,83m) decks



**Upper Silo Climber** AGES: 5-12

- Use for a 5' (1,52m) climb between decks



### Nuvo™ Twist Climber AGES: 5-12

- Diverse footholds and handholds provide a challenging climb
- Attaches to 3' (0,91m), 4' (1,22m), 5' (1,52m), and 6' (1,83m) decks



### Nuvo™ Curvy Climber AGES: 5-12

- Unique curves inspire imaginative play
- Attaches to 3' (0,91m), 4' (1,22m), 5' (1,52m), and 6' (1,83m) decks



### VertiClimber AGES: 5-12

- VertiClimber adds a fun climbing challenge with a modern aesthetic
- Kids love climbing to the top then maneuvering onto equipment for more play



### Silo Climber AGES: 2-12

- Classic ladder climber for easy access
- Attaches to 2' (0,61m), 3' (0,91m), 4' (1,22m), 5' (1,52m), and 6' (1,83m) decks



### Twisted Steel Climber AGES: 5-12

- Curved design increases the challenge level for children
- Attaches to 6' (1,83m), 7' (2,13m), and 8' (2,44m) decks



### GEO Climber AGES: 5-12

- Big, bold design provides a new level of climbing fun
- Curved design increases the challenge level for kids
- Large, sculpted holes are textured to allow for a firmer grip while climbing
- Attaches to 4' (1,22m) and 5' (1,52m) decks

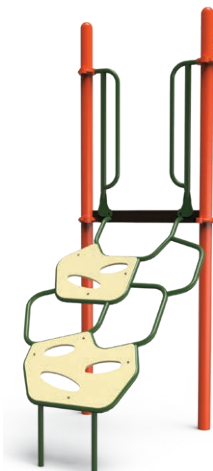

### GEO Arch Climber AGES: 5-12

- Aesthetic design updates a playground classic
- Develops hand/eye coordination and increases upper-body strength
- Attaches to 4' (1,22m), 5' (1,52m), and 6' (1,83m) decks



### GEO Vertical Climber AGES: 5-12

- Vertical path to reach new heights on the playground
- Challenging climber develops hand/eye coordination and increases upper-body strength
- Attaches to 4' (1,22m), 5' (1,52m), and 6' (1,83m) decks



### Round-the-Corner AGES: 5-12

- Round-the-Corner incorporates lower rope climbing activities. Children will delight in Round-the-Corner's three types of climbing while you'll delight in its distinctive design and superb craftsmanship.



**Rushmore™** AGES: 5-12

- Play like never before on a single component!
- Only climbing hill structure of its kind in the industry
- Climb. Crawl. Walk. Roll. Weave.
- Prompts creativity, teamwork, and plenty of action
- Features our heavy duty, flexible flex treads
- Attaches between 4' (1,22m) decks

\*U.S. Patent 9,220,938

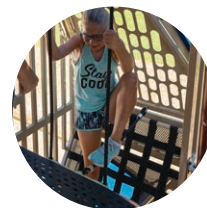

**KaleidoClimber** AGES: 5-12

- Unique design increases play value
- A fun way to move from deck to deck



**Single Flex Tread Climber**

AGES: 5-12

- Single Flex Tread climber available to 4' (1,22m) and 5' (1,52m) decks
- Flexible, textured, and strong flex tread



**Double Flex Tread Climber**

AGES: 5-12

- Double Flex Tread climber available to 4' (1,22m) and 5' (1,52m) decks
- Available only in Playmakers®
- Flexible, textured, and strong flex treads



**Hopscotch Climber** AGES: 2-12

- Grid climber gives kids multiple footing options
- Attaches to 4' (1,22m), 5' (1,52m), and 6' (1,83m) decks



**Ribbon Climber** AGES: 2-12

- Wavy shape adds perceived movement
- Attaches to 3' (0,91m), 4' (1,22m), 5' (1,52m), and 6' (1,83m) decks



**Beanstalk Climber** AGES: 2-12

- Fun, leaf-shaped footholds
- Attaches to 3' (0,91m), 4' (1,22m), 5' (1,52m), and 6' (1,83m) decks





### Deep Rung Arch Climber AGES: 2-12

- Ergonomically designed; graduated rung depths keep kids safe and upright
- Attaches to 3' (0,91m), 4' (1,22m), 5' (1,52m), and 6' (1,83m) decks



### Angled Climber AGES: 5-12

- Use one small and one large climber (sold separately) to connect decks of the same height (4' level only) or different heights
- Small attaches to 2' (0,61m), 3' (0,91m), and 4' (1,22m) decks, and large attaches to 4' (1,22m), 5' (1,52m), and 6' (1,83m) decks



### Spiral Climber AGES: 2-12

- Corkscrew-like ladder promotes hand/eye coordination
- Attaches to 3' (0,91m), 4' (1,22m), 5' (1,52m), and 6' (1,83m) decks



### Tower Steel Climber AGES: 5-12

- Provides easy access to higher areas of the playground
- Attaches to 6' (1,83m), 7' (2,13m), and 8' (2,44m) decks



### Tree Climber AGES: 2-12

- Promotes hand/eye coordination
- Attaches to 3' (0,91m), 4' (1,22m), 5' (1,52m), and 6' (1,83m) decks



### Post w/Ladder Climber AGES: 5-12

- Side attached ladder is open and presents perceived risk
- Connects to 1' (0,30m), 2' (0,61m), 3' (0,91m), and 4' (1,22m) decks



### Rope Ladder AGES: 2-12

- Flexible rope adds challenge to the basic ladder climber
- Ground-to-deck climber available to 3' (0,91m), 4' (1,22m), 5' (1,52m), and 6' (1,83m) decks



### Rope Net Climber AGES: 2-12

- Promotes safe risk taking
- Attaches to 3' (0,91m) and 4' (1,22m) decks



### Rope Ascension AGES: 5-12

- Rope provides dynamic movement and adds challenge
- Ground-to-deck rope climber available to 3' (0,91m), 4' (1,22m), and 5' (1,52m) deck heights

All Adventure Series components are designed for post attachment only.



**The Duplex** AGES: 5-12

- Provides four sides to scale as kids work their way around a structure



**The Crossover** AGES: 5-12

- Part ladder, part traditional monkey bars—this hybrid climber will have kids upside down, right side up, and everywhere in between!



**The Tri-Junction** AGES: 5-12

- Kids will love deciding where they should explore next!
- Provides more design options to branch out in three directions



**The Quad Junction** AGES: 5-12

- Offers kids the ability to climb both inside and outside
- Adds an interesting element to your playground design

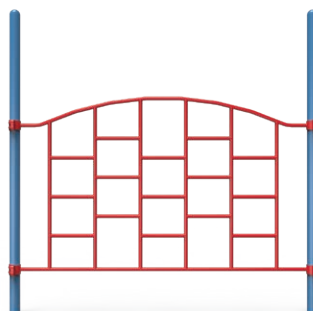

**The Grid** AGES: 5-12

- Steel climbing wall with varied climbing pattern provides challenge



**The Helix** AGES: 5-12

- Creates visual interest as well as increased climbing challenge
- Footings and climbing strategies change as kids move from one end to another

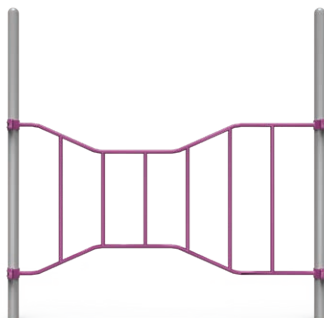

**The Wave** AGES: 5-12

- Kids climb up to the center point, then down the other side



**The Sky Link** AGES: 5-12

- Arched rail with loop handholds creates challenge



**The Sky Arch** AGES: 5-12

- Upper-body strength builder
- Kids can use in different ways, with different hand grips to work their way across



### The Wall

AGES: 5-12

- Not as easy as it looks! Rope netting provides movement—different experience with multiple climbers
- Up, over, around—versatile play and layout possibilities

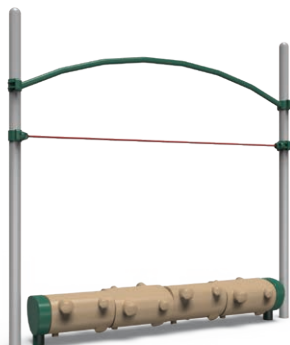

### The Wacky Log

AGES: 5-12

- Fun, themed motion component puts their balance skills to the test!
- Multiple kids can play and challenge one another



### The Criss Cross

AGES: 5-12

- Playful layout of this climbing net creates 3-D effect on playground
- Themed stumps create opportunity for imaginative play



### Slither Slide Arch

AGES: 5-12

- Continues the climbing adventure to access the Slither Slide
- Right or left options available



### The Crater Arch

AGES: 5-12

- Random placement of handholds and footholds in an arch shape requires advanced motor planning skills
- Fun shape with cool plastic insert creates interest



### The Crater Wall

AGES: 5-12

- Large and small handholds and footholds give kids multiple options to scale the wall
- Gives playground distinctive look



### Oval Crater Wall

AGES: 5-12

- Steel rungs, oval plastic inserts, and decking create more climbing challenge



### Oval Crater Arch

AGES: 5-12

- Unique plastic oval combines with steel rails and decking for multiple climbing options!



### The Stump Jump

AGES: 5-12

- Provides opportunity to practice balance
- Fun, themed component allows their imaginations to run wild



### The Vertical Wave

AGES: 5-12

- Sloping rungs provide challenge as kids climb up



### The Crater Ladder

AGES: 5-12

- Sheet plastic with variety of handholds and footholds creates a fun climber

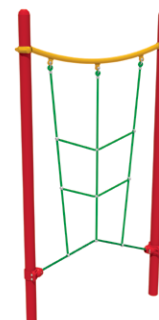

### Rope Link

AGES: 5-12

- A unique rope climbing experience that offers something different from a grid
- Ropes provide movement for challenge and a new experience



### 270° Horizontal Loop Ladder

AGES: 5-12

- Kids will use their upper-body strength to navigate the entire loop
- Returns kids to the adjacent side of the same deck
- Decks up to 3' (0,91m)



### Chinning/Turning Bar AGES: 2-12

- Builds arm and grip strength
- Easy to attach at any height



### Twist 'N Twirl™ AGES: 5-12

- Wheel turns based on kids' movement
- From 1' (0,30m) and 2' (0,61m) decks



### Sky Swivels AGES: 5-12

- Wheels turn based on kids' movement
- From 1' (0,30m), 2' (0,61m), and 3' (0,91m) decks



### Round-About AGES: 5-12

- Helps develop upper-body strength and coordination
- Installs lower for ground access or higher with an access ladder
- Decks up to 3' (0,91m)



### Horizontal Spiral Ladder AGES: 5-12

- 6' (1,83m) length; connect decks of equal height
- Access platforms with the addition of an access ladder
- Installation heights dependent on users and guidelines
- Decks up to 3' (0,91m)



### Overhead Ladder w/Parallel Bars AGES: 5-12

- Builds arm and grip strength
- Helps to promote healthy competition
- 10' (3,05m) length



### Straight Horizontal Loop Ladder

AGES: 5-12

- 6' (1,83m) or 10' (3,05m) length
- Connects decks of equal height
- Connects to end of deck with the addition of an access ladder
- Installation heights dependent on users and guidelines
- Also available in 'S', 'C', and 90° configurations



**Transition Climber** AGES: 5-12

- Link Unity Web or PlayCubes structures with a traditional Challengers® or Playmakers® playground
- Continue the path of play
- Made of coated steel
- Climber attaches PlayCubes to decks from 3' (0,91m) to 6' (0,76m) tall, and Unity Web to 4' (1,22m) decks



**KaleidoCrossing** AGES: 2-12

- Kaleidoscopic bridge makes it fun to move from deck to deck
- Lexan panels provide a colorful experience



**Denali Net Bridge** AGES: 5-12

- Links a 4M or 4M Twin Denali Net to a Playmakers 48" deck.

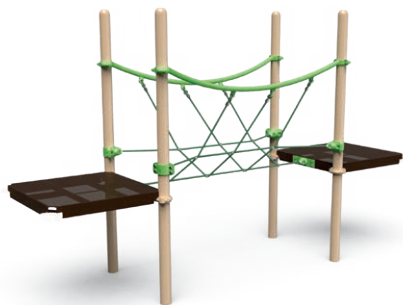

**Canyon Crossing** AGES: 5-12

- 6' (1,83m) long deck-to-deck rope climber connects decks of equal height or with a 12" (0,30m) rise
- Available for use on decks up to 6' (1,83m) high



**Deck-to-Deck Rope Bridge** AGES: 5-12

- Promotes balance and coordination
- Available in 6' (1,83m) and 10' (3,05m) lengths to connect decks of equal height
- Connect 2' (0,61m), 3' (0,91m) and 4' (1,22m) decks of equal height



**Converge** AGES: 5-12

- Converge is a high climbing experience from Playworld! It's more than your average corner climber—it provides multiple climbing experiences, including net climbing and metal components.
- Converge gives kids several climbing paths from the ground to both 6' and 8' platforms, from ground to deck or deck to deck.

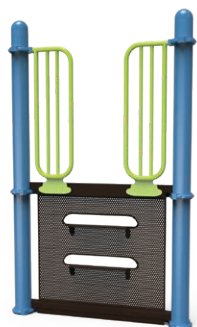

**Deck-to-Deck Climber** AGES: 2-12

- Perforated steel climber
- Available in 1' 6" (0,46m), 2' (0,61m), 2' 6" (0,76m), and 3' (0,91m) heights



**Lily Pods** AGES: 2-12

- Fun moving pods create a walkway from one area to another
- Each Lily Pod is chained to the ground for extra safety
- Available in straight and 1' (0,30m) rise configurations

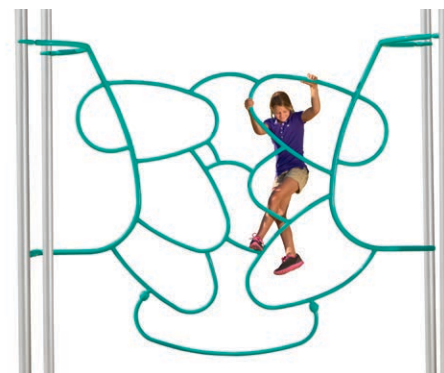

**Nuvo™ Loop Climber** AGES: 5-12

- Offers a variety of fun climbing routes
- Provides deck-to-deck and ground-to-deck access in one climber
- 10' (3,05m) span connects two 4' (1,22m) decks



**Arch Bridge** AGE: 2-12

- Available in 6' (1,83m) and 10' (3,05m) lengths
- Connects decks of equal height from 2' (0,61m) up to 9' (2,74m)
- Available in GEO and Playwood™ themes



**Ripple Bridge** AGES: 2-12

- Flexible motion bridge—ripple effect adds even more fun when multiple kids play on it
- Available in 6' (1,83m) and 10' (3,05m) lengths
- Connects decks of equal height from 1' (0,30m) up to 4' (1,22m)



**Crazy Bones Bridge** AGES: 2-12

- Overhead activity below bridge for added fun
- Available in 6' (1,83m) and 10' (3,05m) and 6' (1,83m), with either a 1' (0,31m) or 2' (0,61m) rise
- Custom lettering available (inset)



**Adventure Bridge** AGES: 2-12

- Moving bridge shifts as kids cross
- Perforated steel planks with guardrails for added safety
- Connects decks of equal height at 2' (0,61m), 3' (0,91m), and 4' (1,22m)
- Available in 6' (1,83m) and 10' (3,05m, shown) lengths

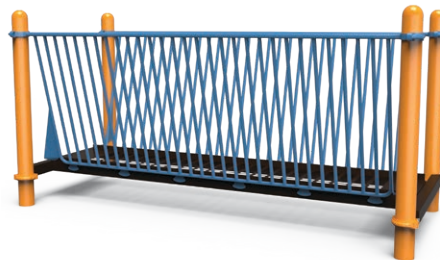

**Catwalk** AGES: 2-12

- Creates the illusion of risk
- Available in 6' (1,83m, shown) and 10' (3,05m) lengths
- Connects decks of equal height from 1' (0,30m) to 9' (2,74m); between decks with a 1' (0,30m) height difference



**90° Cloud Walk** AGES: 2-12

- Textured treads for safer footing
- Available in a 3' (0,91m) rise deck-to-deck version
- Connect decks of equal heights from 2' (0,61m) up to 9' (2,74m)

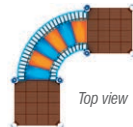

**KaleidoCrossing Catwalk** AGES: 2-12

- Kaleidoscopic bridge makes it fun to move from deck to deck
- Lexan panels provide a colorful experience



**Timber Trail Bridge** AGES: 5-12

- Flexible motion bridge has steel handrails and uneven trail planks to improve kids' balance skills
- Available in 6' (1,83m) and 10' (3,05m, shown) lengths; connects decks of equal height from 1' (0,30m) up to 4' (1,22m) decks



**PlayWood™ Arch Bridge** AGES: 2-12

- Curved design adds woodland appeal to your playground
- Available in 6' (1,83m) and 10' (3,05m, shown) lengths
- Connects decks of equal height from 2' (0,61m) up to 9' (2,74m)

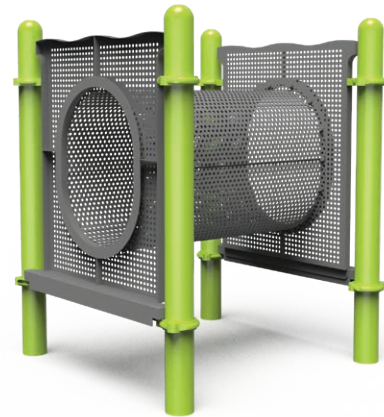
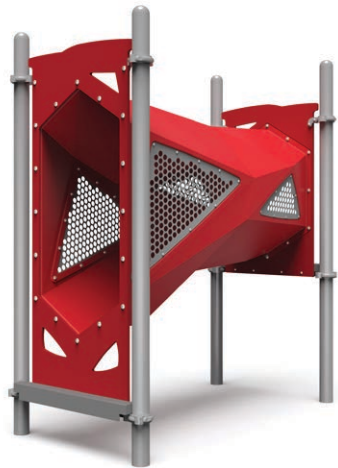

**The Funnel** AGES: 2-12

- Different entrance and exit heights add to the adventure as children move from walking to crawling in this horizontal passageway
- Connects decks of 1' (0,30m) or 2' (0,61m) difference in height
- Also available in ground-to-deck
- 6' (1,83m) long x 1' 11-3/4" (0,60m) wide openings

**Coated Oval Crawl Tube** AGES: 2-12

- 4' (1,22m) long, oval-shaped, horizontal passageway
- Available in both deck-to-deck (of equal height) and ground-level options
- Coated perforated steel for extra durability
- 1' 11-3/4" (0,60m) tall and wide openings



**Log Tube** AGES: 2-12

- Children can pretend they are animals of the forest as they climb through the 6' (1,83m) log, using it as a secret passage
- Open holes permit children to see outside while allowing light to pass through

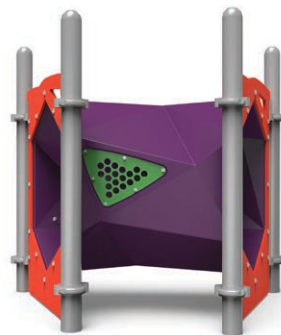

**Adventure Tube The Bend**

- AGES: 2-12
- 3' 6" (1,07m) long, 45° horizontal passageway
  - Available in both deck-to-deck (of equal height) and ground-level options
  - 1' 11-3/4" (0,60m) tall and wide openings



**Adventure Tube The Passage**

- AGES: 2-12
- 4' (1,22m) long, straight horizontal passageway
  - Available in both deck-to-deck (of equal height) and ground-level options
  - 1' 11-3/4" (0,60m) tall and wide openings

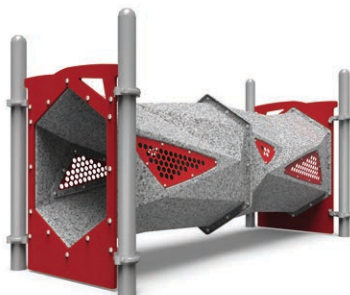

**Adventure Tube The 'S' Turn**

- AGES: 2-12
- 6' (1,83m) long S-shaped, horizontal passageway
  - Available in both deck-to-deck (of equal height) and ground-level options
  - 1' 11-3/4" (0,60m) tall and wide openings

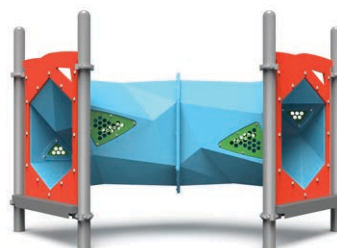

**Adventure Tube The 90° Turn**

- AGES: 2-12
- 7' (2,13m) long, 90° horizontal passageway
  - Available in both deck-to-deck (of equal height) and ground-level options
  - 1' 11-3/4" (0,60m) tall and wide openings



**Adventure Tube The Vertical 'S' Turn**

- AGES: 2-12
- 6' (1,83m) long, S-shaped vertical passageway
  - Connects decks with a difference of 3' (0,91m) in height
  - Also available in a ground-to-deck version
  - 1' 11-3/4" (0,60m) tall and wide openings



### Brig Panel

AGES: 2-12

- No pirate ship would be complete without its own Brig!
- Barrier completes the look of your ship
- Available in Challengers® only



### Drum Cannon Panel

AGES: 2-12

- Ready. Aim. Fire! Peek through the window, hold the cannon handles, and aim at the enemy ship
- Pound on the cannon to fire, or even to play your own drum music
- Features a clear Lexan® window for super-durability
- Available in Challengers® only



### Nautical Porthole Panel

AGES: 2-12

- Perfect finishing touch for your nautical-themed play structure
- Porthole barrier made of clear, durable Lexan®
- Available in Challengers® only



### Sunken Treasure Hunt Panel

AGES: 2-12

- Turn your playground into a treasure hunt
- Spin the dial and search for the treasures hidden throughout your playground on icons, which are attached to posts
- Treasures include jewels, crown, crest, sword, key, and ring
- Available in Challengers® only



### Castle Treasure Hunt Panel

AGES: 2-12

- Turn your playground into a treasure hunt
- Spin the dial and search for the treasures hidden throughout your playground on icons, which are attached to posts
- Treasures include jewels, crown, crest, sword, key, and ring
- Available in Challengers® only

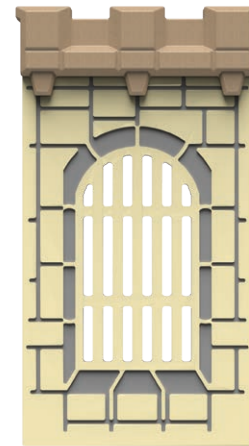

### Castle Window Barrier

AGES: 2-12

- Aesthetically-appealing brick pattern serves as a barrier to protect children
- Available in Challengers® only



### Steering Wheel Half Panel

AGES: 2-12

- Kids will have a blast steering the ship with this nautical-themed wheel
- Available in Challengers® Only





### Nature Hunt Panel

AGES: 2-12

- Kids will love exploring for animal shapes (shown on panel), which are attached to posts throughout the playground
- Provides an opportunity to teach children about nature and science



### Tree House Doorway

AGES: 2-12

- Inspires kids to create a hideout or club house
- Supports free play and encourages exploring



### Window Planter Panel

AGES: 2-12

- Children can plant seeds and watch them sprout and grow
- Provides an opportunity to teach kids about nature and science



### Tree House Barrier

AGES: 2-12

- Looks like a window in a tree house, encouraging kids to pretend play



### PlayWood™ Barrier

AGES: 2-12

- Keeps children safe and adds to your nature aesthetics



### Magnifying Panel

AGES: 2-12

- Children will pretend to be scientists discovering new plant life, valuable minerals, or never-before-seen insects!



Plug kids into KPE, the interactive play panels that run on the ultimate green energy: Kid Power! The more kids spin, push, and press KPE's wheels and buttons, the more silly music and sound effects they generate. With KPE, kids power the play!



### KPE Animal Tunes

AGES: 2-12

- Kids spin the knob to hear their favorite jungle and farm animals
- Features six different songs with realistic animal sound effects
- Available in full and half panels, and a post-attachment version

**TOP INCLUSIVE PRODUCT**



### KPE Drive-Away

AGES: 2-12

- Kids turn a knob to choose one of five vehicles (car, train, fire truck, boat, or spaceship) to drive
- Steer the wheel to power it up; hear music and sounds corresponding to each vehicle
- Dashboard features interactive gadgets, including a radio, security alarm, horn, and ignition
- Available in full- and half-panel versions

**TOP INCLUSIVE PRODUCT**



### KPE Rhythm Spinner

AGES: 2-12

- Spin the dial to hear one of ten songs; reverse directions to change tune
- Hit the drum pads to play along with the music; each drum pad features a different sound
- Ability to record voice and playback
- Available in full- and half-panel versions

**TOP INCLUSIVE PRODUCT**



### KPE Nature Sounds

AGES: 2-12

- Kids spin the knob to hear their favorite nature sounds, transporting them deep into the forest
- Provides an opportunity to teach kids about nature and science
- Supports free play and exploration
- Available in full and half panels, and a post-attachment version

**TOP INCLUSIVE PRODUCT**



**Airplane Half Panel** AGES: 2-12

- Promotes gross and fine motor skills, and hand/eye coordination

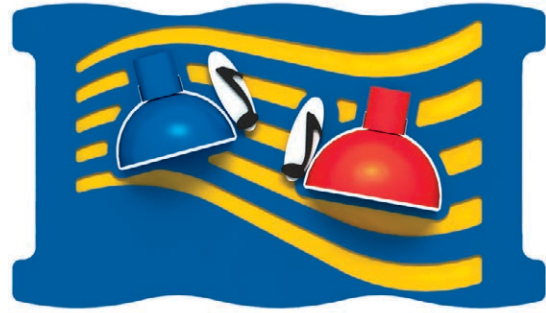

**Bell Half Panel** AGES: 2-12

- Use attached plastic music notes to ring bells
- Two-sided panel promotes auditory awareness

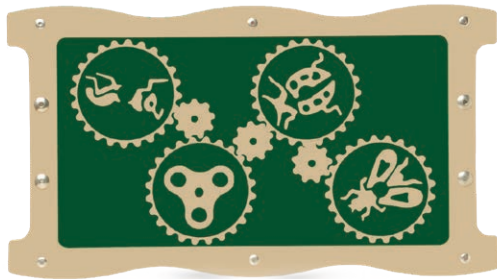

**Bugs Half Panel** AGES: 2-12

- Promotes gross and fine motor skills, and hand/eye coordination



**Driver Half Panel** AGES: 2-12

- Promotes imaginative opportunities and gross motor skills

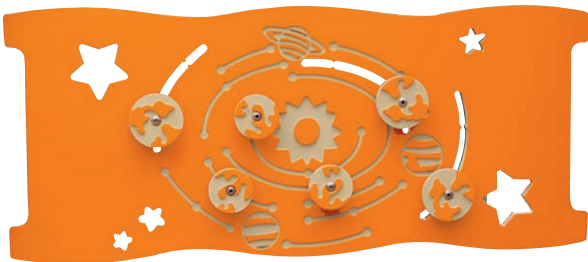

**Solar System Half Panel** AGES: 2-12

- Promotes gross and fine motor skills, and eye/hand coordination



**Maze Half Panel** AGES: 2-12

- Builds attention spans, cognitive thinking, and a sense of discovery

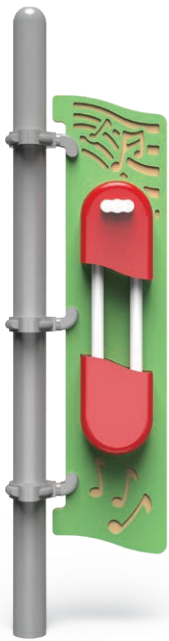

**Chimes Banner** AGES: 2-12

- Single chime with two different tones



**Post Mount Bells** AGES: 2-12

- One unique tone for each of the four bell sizes: 7" (17,78cm), 8" (20,32cm), 9" (22,86cm), and 10" (25,4cm)



**Bell Panel** AGES: 2-12

- Use attached plastic music notes to ring bells
- Four unique bell tones build auditory awareness
- Ground-level and deck-level versions available

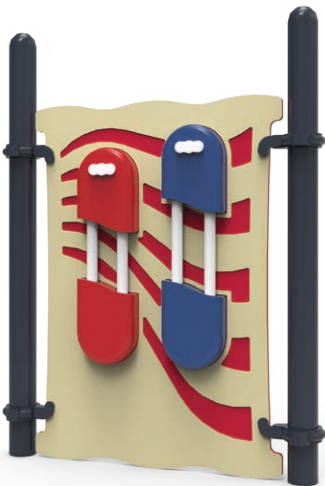

**Chime Panel** AGES: 2-12

- Built-in spinning mallet rings chime
- Ground-level and deck-level versions available



**Horn Panel** AGES: 2-12

- Press for two distinct horn noises
- Promotes rhythm, hand/eye coordination, and fine motor skills
- Ground-level and deck-level versions available

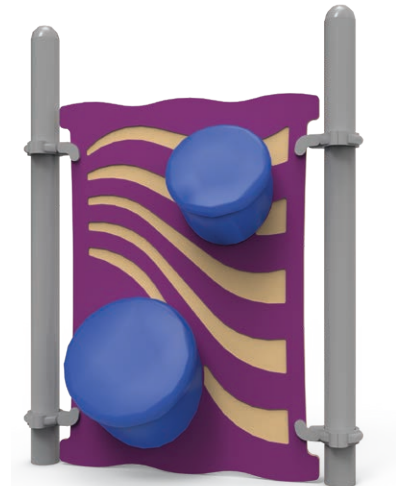

**Drum Panel** AGES: 2-12

- Bongo-style drums in varying tones
- Ground-level and deck-level versions available
- Also available as single drum panel to attach to single post

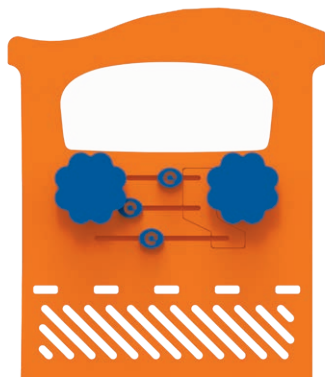

**Whimsy Wheel Panel** AGES: 2-5

- Little ones will delight in spinning wheels and sliding knobs on this whimsical panel
- Available in ground-level and deck-level versions for Challengers® only



**Garden Panel** AGES: 2-5

- Imaginations soar as children slide butterflies through the garden
- Available in ground-level and deck-level versions for Challengers® only

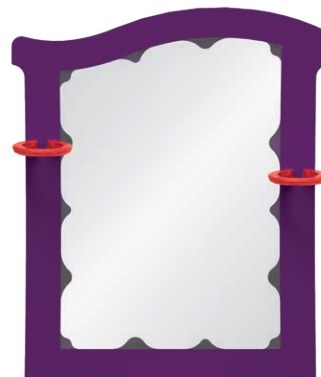

**Art Panel** AGES: 2-5

- Kids can explore their creative side on this washable, Lexan® panel
- Integrated cup holders for art supplies
- Available in ground-level and deck-level versions for Challengers® only

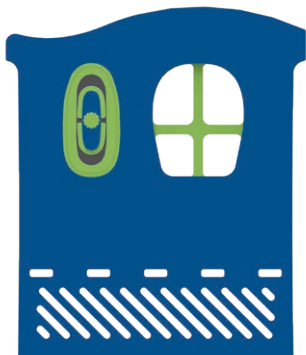

**Window Panel w/Push Clicker** AGES: 2-5

- Young children can look out the window or push the button to “turn on the lights”
- Encourages imaginative role playing
- Available in ground-level and deck-level versions for Challengers® only

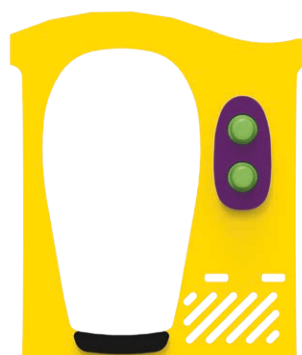

**Door Panel** AGES: 2-5

- Create an entrance to an under-deck hideaway
- Fine motor skills are improved using the rattle knobs
- Available in Challengers® only



**Spin Racer Panel** AGES: 2-12

- Promotes cognitive development and encourages social interaction

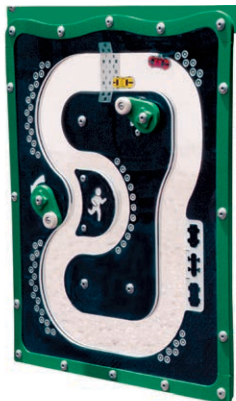

**Driver Panel** AGES: 2-12

- Spinning knobs move cars around track



**Tic-Tac-Toe Panel** AGES: 2-12

- Promotes hand/eye coordination and builds dexterity



**Scavenger Hunt Panel** AGES: 2-12

- Children will go on a 'Scavenger Hunt' to find icons (shown on panel), which are attached to posts throughout the playground
- Also available to attach to single post



**Treasure Tumble Panel** AGES: 2-12

- Features a Treasure Tumble (clear cylinder) filled with plastic beads and larger plastic objects to find
- Lists the objects which can be found inside the Treasure Tumble



**Slide-n-Learn Panel** AGES: 2-12

- Promotes color, number, and shape recognition



**Find The Way Home Panel** AGES: 2-12

- Two-sided, finger-tracing panel promotes cognitive development
- Different maze on each side



**ABC/123 Panel** AGES: 2-12

- Promotes letter and number recognition
- Builds attention span, cognitive thinking, and self-confidence



**Storefront Panel** AGES: 2-12

- Encourages role playing, socialization, imaginative and group play



**Bubble Panel** AGES: 2-12

- Lexan® bubble offers a fun perspective



**Crawl-Thru Panel** AGES: 2-12

- Create an entry for under-deck play spaces

## Activity Panels

AGES: 2-12

Promote interactive, sensory, and inclusive play with activity panels for your Challengers® or Playmakers® structure. From world-altering effects to games that make you think, these panels offer something for everyone. Just select your Activity Panel Frame color, then pick an Activity Panel Insert (colors as shown below).

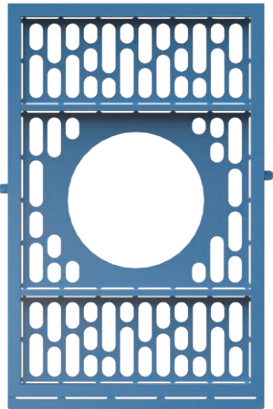

Contained Activity Panel

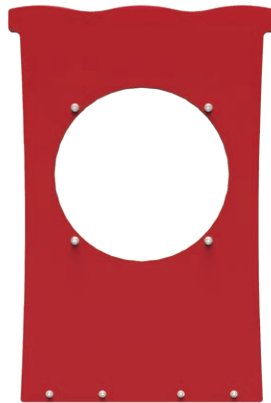

Activity Panel



*Garden Panel not compatible with Very Buried Insert. Slide & Solve Insert does not meet ADA requirements.*

Garden Panel



Hypnotize Insert

- Spin the outer ring to feel the dizzying pull of this optical illusion

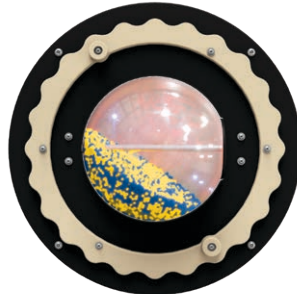

Very Buried Insert

- Rotate the sphere to shift the pebbles and reveal hidden treasures



Funhouse Insert

- Laugh at your distorted reflection in this wacky cracked mirror



A-maze-ing Insert

- Turn the outer ring to direct the metal ball into the center and back again

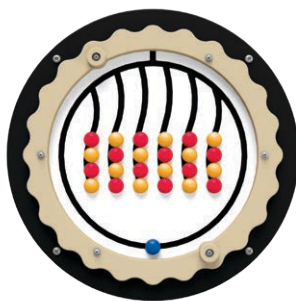

Four-the-Win Insert

- Grab a partner and match four caps in a row to win, or invent your own rules

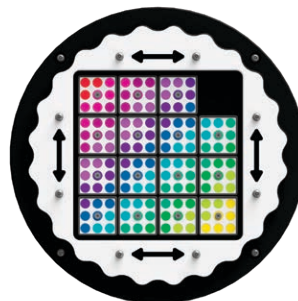

Slide & Solve Insert

- Slide the tiles vertically and horizontally to solve the puzzle



Magical Music Insert

- Make your own music in mode setting or listen to preset tunes at the touch of a button

Puzzle inserts offer a range of puzzle challenges! Navigate the ball through a maze or make the gears spin. Our sweeping variety of activities provides fun and challenges that build hand-eye coordination and improve motor skills.

Available for both Nuvo™ and Classic style panels. Designed for ages 2-12.



Nuvo™ Panel Frame



Classic Panel Frame



Ball Maze Insert

- Metal ball is maneuvered through the maze by rotating the captain's wheel



Catacombs Insert

- Rotate and turn the outer ring to maneuver a ball through the maze of catacombs



Construction Insert

- Maneuver metal balls into dump trucks, diggers, and dozers



Shifting Sands Insert

- Balls shift as sun shape is spun



Rainbow Insert

- Color filters let children see their surroundings in a whole new way and learn about the impact of color



Tactile Insert

- Touch and feel the differences in surfaces of various textures



Move It Insert

- Helps develop hand/eye coordination
- Creates the sound of rain when spun, stimulating auditory awareness

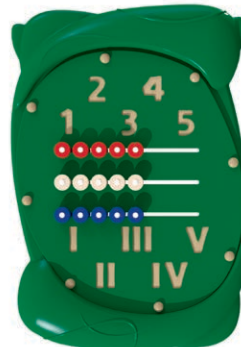

Counting Insert

- Sliders help develop basic math skills and encourage neural processes



Gears Insert

- Ball moves through designs as gears rotate and turn



### Stepped Platform

- Facilitates an accessible route to higher elevations
- Four heights available: 1' (0,30m), 1' 6" (0,46m), 2' (0,61m), and 3' (0,91m)



### Stairs & Ladder

- Stairs have wider treads for up and down climbing to 2' (0,61m), 3' (0,91m), and 4' (1,22m) decks
- Ladder has narrow treads for ascent only with a single handrail and provides access to 5' (1,52m) and 6' (1,83m) decks

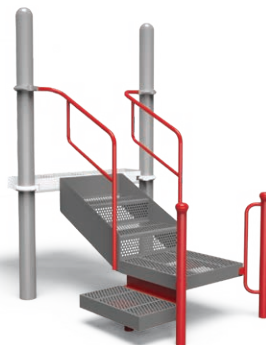

### Transfer Station

- Provides an accessible route
- Ideal for wheelchair transfer from deck heights of 3' (0,91m) and 4' (1,22m) platforms



### Nuvo™ Transfer Station

- New design allows children to transfer from both sides
- Unique look adds flair to your Nuvo playground
- Available to 3' (0,91m) and 4' (1,22m) decks



### Wheelchair Ramps

- Width allows two kids in wheelchairs to sit side-by-side or pass each other
- Easy turn-around prevents 'traffic jams'
- Available in wide and standard widths



### Barriers

- Keeps children safe
- Available in Balcony (shown), and several variations of Pipe Wall Barriers



### GEO Barrier

- Keeps children safe and features a contemporary, aesthetic design



### GEO Access Gate

- Features a contemporary, aesthetic design
- Only available in Playmakers™



Telescope for PlayWood Barrier

### Telescope AGES: 2-12

- Telescope allows children to engage in pretend play
- Pipewall barrier and add-on options for increased play value

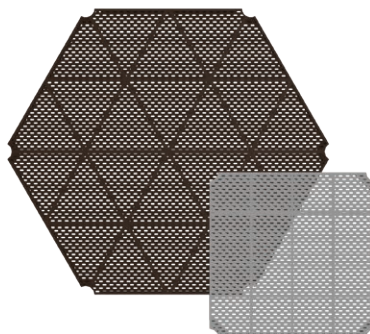

### Coated Decks

- Available in hex, half hex, triangular, half square, and square versions
- Accommodates four activities for square-shaped decks and six for hex-shaped decks



### PlayWood™ Square Deck

- Natural look with textured surface for added slip resistance
- Available in square and hex versions



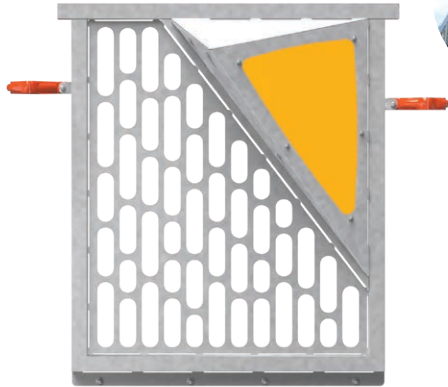

**KaleidoBarrier** AGES: 2-12

- Bright panels add color to your Sky Towers®
- Keeps kids safe and makes supervision easy



**Disco Spinner** AGES: 2-12

- Bring light play to the ground
- Be a disco sun DJ!
- Available in Playmakers® Only

**TOP INCLUSIVE PRODUCT**



**Babble-On** AGES: 2-12

- Includes two cast aluminum talk horns with connecting tubes
- Available in ground-level only

**TOP INCLUSIVE PRODUCT**



**Steering Wheel** AGES: 2-12

- Easy pretend play add-on for any type of playground; ideal for any of our themed playgrounds.
- Attaches to pipewall, balcony, post, and classic insert panels to create a pretend vehicle
- A great inclusive activity



**Step Around** AGES: 2-12

- Cast aluminum, post-mount stepping stone
- Textured for "sure" footing



**Sling Seat** AGES: 2-12

- Create a cozy spot under decks with this seat
- For use under decks 4' (1,22m) and higher



**Playseat** AGES: 2-12

- Ideal for play spaces under decks



**Anywhere Seat** AGES: 2-12

- Add seating to any 3-1/2" (0,09m) or 5" (0,13m) post

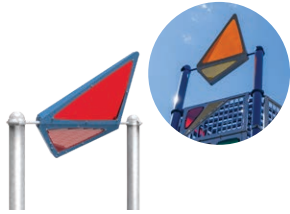

## Kinetic Topper

- Pivots gently in the breeze
- Add movement to your Sky Towers®
- Available in Playmakers® only



## Kinetic Flag

- Give a distinctive new look to any Challengers® or Playmakers® system
- Colorful and sways gently in the breeze, creating a bright sensory experience that children delight in
- Select a colorful polycarbonate insert or create your own custom graphic insert. (Inserts sold separately)



## Nuvo™ Roof

- Appears to be floating above the playground
- Graceful curves and swirls add fresh appeal



## Nuvo™ Swirl Roof

- Roof designed with a skylight
- Graceful curves and swirls add fresh appeal
- Four-post connection



## PlaySoleil™

- LED post top security night light
- Solar powered rechargeable battery
- Fits: 3.5", 4" and 5" posts



## Skylight

- Add a splash of color to your play space
- Skylights create colorful shadows that children love to interact with
- Provides a sensory experience as well as shade



## Camber Half Square Roof

- Use in pairs (shown) or alone to provide economical sun protection
- Underside features outer-space embossing for visual interest



## Camber Hex Roof

- Shade as much or as little as you like
- Full deck coverage for maximum sun protection
- Save money while still providing sun protection
- Full Roof (shown) and Open Roof option available

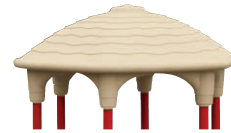

## Hex Cabana Roof

- Same great features as our Cabana Roof but in a hexagonal shape



## Perforated Steel Carnival Roof

- Sturdy, colorful, perforated steel shade
- Available for use with square (shown), extended square, hex, and extended hex decks



## Corrugated Peak Roof

- Add a rustic touch to your playground
- Made of sturdy corrugated steel
- Also available as a slant roof



## PlayWood™ Peak Roof

- The perfect finishing touch for your tree house
- Also available as a slant roof



## Nautical Sail

- Completes the look of your nautical-themed playground
- Each sail sold separately
- Available in Challengers® only



## Castle Arch

- Create the perfect entrance to your castle-themed playground
- Available in Challengers® only



## Themed Flags

- Adds the perfect finishing touch to your themed playground
- Choose from options shown
- Available in Challengers® only



## Post Tops

- Adds fun visual impact to any playground; many colors, styles, and sizes add interest and height
- The perfect finishing touch to complete your play structure



## Cabana Roof

- Stylized roof with molded shingles and arched entrances

## Shade

- Blocks up to 96% of the sun's UV rays
- Keeps playground up to 20 degrees cooler
- Designed to withstand nominal wind loads of 90 mph (144,84 kph) with appropriate footing
- To extend the life of shade, the shade must be removed for winter in snowy regions
- Requires little to no maintenance
- One-piece fabric design for maximum coverage
- Canopies available in 2 sizes – 16' (4,88m) and 20' (6,1m)
- Hypar shade features catenary design system that suspends the fabric away from any structural material that may abrade the fabric
- Choice of one fabric color and one paint color (fabric colors on page 205)
- Shade Hats are available as in-ground mount only

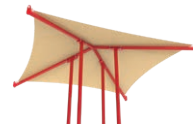

Hat Shade Square-shaped



Canopy Shade



Hat Shade Hex-shaped



Hypar Shade

# PLAYWORLD LIMITED WARRANTY

Playworld Systems, Inc. warrants its products against structural failure due to defects in materials and workmanship for the warranty periods and material categories prescribed below.

- LIMITED WARRANTY FOR AS LONG AS YOU OWN THE PRODUCT:** Steel deck support posts, stainless steel hardware, clamps, deck hangers, post caps, and cast aluminum parts, except as otherwise specified below.
- LIMITED TWENTY-FIVE (25) YEAR WARRANTY:** Spring Mates® aluminum castings.
- LIMITED FIFTEEN (15) YEAR WARRANTY:** Perforated steel decks and stairs, steel rails, stationary weldments, rotationally-molded and sheet plastic components, Playworld recycled plastic lumber, roof panels, and stainless steel slides, except as otherwise specified below.
- LIMITED TEN (10) YEAR WARRANTY:** Fiberglass signage, Fun Centers™, FirstPlay™ play structures, pre-cast PolyFiberCrete® or reinforced concrete products, Timber Stacks™ Robinia timbers and galvanized hardware, non-stainless steel hardware, fabric shade steel frames and Shadesure and Colourshade FR fabrics (Note Exception: Limited Five (5) Year Warranty on fabrics in colors Red, Yellow, Electric Purple, Zesty Lime, Cinnamon, and Olive.)
- LIMITED FIVE (5) YEAR WARRANTY:** Steel reinforced cable net and rope fittings and connections (Note Exception: Warranty does not cover normal wear and tear such as fraying or fading of cable coating), PlaySimple® play structures, DropZone Tower™, LiveWire Zip Line™ (except as otherwise specified below), AeroGlider™, Border Timbers™, wood and polycarbonate panels, PE coating and PVC coating (against cracking and peeling), site amenities (i.e. benches, tables, litter receptacles, and bike racks), GFRP (Glass Fiber Reinforced Polymer) products, accessible swing seats latch and hinge mechanism, and motion/moving play components and parts.
- LIMITED THREE (3) YEAR WARRANTY:** Steel coil and C springs, flat webbing nets (excluding normal wear and tear), electronic panel speakers, sound chips, flex treads, and circuit boards.
- LIMITED ONE (1) YEAR WARRANTY:** NEOS®, electronic based play products, swing chain, swing clevises, swing galvanized attachment hardware, molded rubber bumpers, handholds, swing seats, and any other materials or custom products not covered above, all high wear items such as trolleys, cables, wheels, and bumper stops related to rail and cable ride products. (\*For NEOS only, an extended 3-year warranty is available for purchase, providing 4 years of cumulative coverage.)
- LIMITED SIX (6) MONTHS WARRANTY:** PlaySoleil solar powered light.

**BUYER'S REMEDY:** If any products prove defective or non-conforming under normal use and within the above-prescribed warranty periods and material categories, Buyer must promptly notify Playworld Systems, Inc. in writing at 1000 Buffalo Road, Lewisburg, PA 17837 USA. Playworld may elect to inspect the alleged defect at Buyer's site or at Playworld's facility. Buyer shall not return products to Playworld unless authorized by Playworld to do so. Authorized returns must be properly packaged and shipped prepaid and insured, at Buyer's expense. Upon verification of warranty coverage, Playworld may elect, in its sole discretion, to repair defective or non-conforming products, or replace them by delivering products or parts free of charge to the site. Playworld's limited warranties do not cover the cost of labor to remove defective or non-

conforming parts or to install repaired or replacement parts. By use of these limited warranties, Buyer accepts their terms and limitations, and waives any rights it would otherwise have to claim or assert that such warranties fail of their essential purpose. Buyer agrees that venue for any court action to enforce these limited warranties shall be in Union County in the State of Pennsylvania.

**LIMITATIONS:** All warranty periods begin on the date of Playworld's invoice. Repaired and/or replacement parts are warranted only for the balance of the original limited warranty period. Warranties extend only to the original Buyer/end user for products purchased from Playworld or a Playworld authorized reseller, and are not transferable.

Warranties apply only to Playworld products that are erected and installed in conformance with Playworld installation instructions, and that are maintained and inspected in conformance with Playworld maintenance and operational instructions.

Warranties specifically do not cover Playworld products:

- for cosmetic damage or flaws occurring under normal use, such as surface scratches, minor chips, hairline cracks, dents, marring, efflorescence, color fade, discoloration, corrosion/rust, fraying, or warping of recycled plastic lumber;
- that have been modified, altered, or repaired by unauthorized third parties;
- that have not been used as designed or intended, or misused;
- to which non-Playworld parts have been added or substituted;
- that have been removed from their original location and re-installed elsewhere;
- for changes in appearance of natural materials over time or cosmetic defects such as checks or splits in timber components;
- or that have been damaged due to excessive wear and tear, vandalism, abnormal use, abuse, negligence, environmental factors (such as wind-blown sand, salt spray, or airborne emissions from industrial sources), extreme weather (such as hail, flooding, lightning, tornados, sandstorms, earthquakes, or wind storms), and acts of God.

Playworld does not warrant that any particular color will be available for any specific period of time, and reserves the right, in its sole discretion, to discontinue any color for any reason.

**THE FOREGOING LIMITED WARRANTY IS THE SOLE AND EXCLUSIVE WARRANTY FOR SELLER'S PRODUCTS, AND IS IN LIEU OF ALL OTHER WARRANTIES, EXPRESS OR IMPLIED, IN LAW OR IN FACT. SELLER SPECIFICALLY DISCLAIMS ALL OTHER WARRANTIES, EXPRESS OR IMPLIED, INCLUDING, WITHOUT LIMITATION, ALL IMPLIED WARRANTIES OF MERCHANTABILITY AND FITNESS FOR A PARTICULAR USE OR PURPOSE, AND ANY IMPLIED WARRANTIES ARISING OUT OF COURSE OF DEALING OR PERFORMANCE OR TRADE USAGE. SELLER SHALL NOT BE LIABLE FOR ANY INCIDENTAL, CONSEQUENTIAL, EXEMPLARY, SPECIAL, OR PUNITIVE DAMAGES, OR ANY LOSS OF REVENUE, PROFIT, OR USE ARISING OUT OF A BREACH OF THIS WARRANTY OR IN CONNECTION WITH THE SALE, INSTALLATION, MAINTENANCE, USE, OPERATION, OR REPAIR OF ANY PRODUCT. IN NO EVENT WILL SELLER BE LIABLE FOR ANY AMOUNT GREATER THAN THE PURCHASE PRICE OF A DEFECTIVE PRODUCT.**



## Safety & Standards

**CERTIFICATIONS AND SAFETY STANDARDS:** ISO 14001 certification guarantees that Playworld Systems, Inc. meets the highest standards for environmental-responsible manufacturing.

ISO 9001 certification guarantees that Playworld Systems, Inc. meets stringent quality-control standards in manufacturing our play equipment.

**The Consumer Product Safety Commission (CPSC)** – Look for “CPSC Pub.325” to see Playworld Systems, Inc.’s CPSC-compliant products.

- **CPSIA** – Playworld Systems, Inc.’s products meet or exceed the requirements of the Consumer Products Safety Improvement Act (CPSIA) of 2008.



The European Norm (EN) covers general safety requirements and test methods. Look for “EN1176” to see Playworld Systems, Inc.’s EN-compliant products.



The European RoHS directive restricts the use of six hazardous materials in the manufacture of electronic equipment, and seeks to reduce the amount of hazardous materials entering electronic products. All Playworld Systems, Inc.’s electronic products are RoHS compliant.

- **Singaporean Standard** – Based primarily on the ASTM standards, the Singaporean Standard is widely used throughout Asia.



In the interest of playground safety, the International Play Equipment Manufacturers Association (IPEMA) provides a Third Party Certification Service

whereby a designated independent laboratory, TÜV SÜD America Inc., (TÜV), validates an equipment manufacturer’s certification of conformance to the ASTM F1487 Standard Consumer Safety Performance Specification for Playground Equipment for Public Use, except sections 7.1.1, 10, 13.1.1, 13.1.2, 13.2, and 13.3; to CAN/CSA Z614 Children’s Playspaces and Equipment, except clauses 10 and 11; or both. A list of current validated products may be viewed at [www.ipema.org](http://www.ipema.org).

In the Interest of playground safety, the International Play Equipment Manufacturers Association (IPEMA) provides a Third Party Certification program whereby a designated independent laboratory, TÜV SÜD America Inc., (TÜV), validates a surfacing manufacturer’s certification of conformance to ASTM F1292, Standard Specification for Impact Attenuation Under and Around Playground Equipment Performance Criterion, Section 4.2; ASTM F1292, Standard Specification for Impact Attenuation Under and Around Playground Equipment Performance Criterion (in its entirety); ASTM F3351, Standard Test Method for Impact Testing In Laboratory at Specified Test Height; and for an engineered wood fiber manufacturer its certification of conformance, also to ASTM F2075, Standard Specification for Engineered Wood Fiber for Use as a Playground Safety Surface Under and Around Playground Equipment; and for a Loose Fill Rubber manufacturer its certification of conformance, also to ASTM F3012, Standard Specification for Loose Fill Rubber for Use as a Playground Safety Surface under and around Playground Equipment. A list of current validated products, their thickness and critical height may be viewed at [www.ipema.org](http://www.ipema.org).

**TERMS OF SALE • PRICES:** Prices are subject to change without notice. Unless otherwise stated in writing, all prices are F.O.B. Lewisburg, PA, USA, and shall be exclusive of installation, surfacing, transportation, insurance, taxes, license fees, customs fees, duties, premiums, fees, and other charges. DESIGN: Playworld Systems, Inc. continually improves play equipment to better serve our customers and therefore reserves the right to change the design specifications without notice.

# Index

270° Horizontal Loop Ladder .....	186	Challengers® Jungle Excursion .....	74	Frog Climber .....	155
360° Stainless Steel Slide .....	173	Challengers® Leila's Landing .....	88	Fun Centers™ Design #1 .....	100
90° Cloud Walk .....	188	Challengers® Lilah's Lookout .....	114	Fun Centers™ Design #2 .....	100
90° Glide Slide .....	171	Challengers® Log Slide .....	109	Fun Centers™ Design #3 .....	101
ABC/123 Panel .....	195	Challengers® Maycee's Maze .....	87	Fun Centers™ Design #4 .....	101
Accessible Climber .....	180	Challengers® Monorail .....	131	Fun Centers™ Design #5 .....	100
Accessible Swing Seat .....	133	Challengers® Natural Nook .....	109	Fun Centers™ Design #7 .....	101
Accessible Whirl .....	122	Challengers® Northern Lights .....	112	Funky Animals .....	129
Activity Panels .....	196	Challengers® Penn's Woods .....	75	Gator Climber .....	155
Adventure Bridge .....	188	Challengers® Pirate's Cove .....	76	Garden Panel .....	194
Adventure Series Components .....	184-185	Challengers® Rhythm Wall .....	138	Gears Insert .....	197
Adventure Tubes .....	16, 135, 189	Challengers® Rockin Reef .....	84	GEO Access Gate .....	198
AeroGlider™ .....	168	Challengers® Sarah's Palace .....	77	GEO Arch Bridge .....	181
Airplane Half Panel .....	192	Challengers® Scavengers Castle .....	111	GEO Arch Climber .....	181
Angled Climber .....	183	Challengers® School Yard Junction w/ Shade .....	112	GEO Barrier .....	198
Anywhere Seat .....	199	Challengers® Slide Shuffle .....	114	GEO Climber .....	181
Arch Bridge .....	188	Challengers® Spin Central .....	125	GEO Vertical Climber .....	181
Arch Swings .....	133	Challengers® Step & Slide .....	113	Glide Slide .....	134, 172
Art Panel .....	194	Challengers® Tic-Tac-Go! .....	114	Gorilla Tunnel Climber .....	154
Babble-On .....	199	Challengers® Timber Grove .....	108	Hammerhead Shark Climber .....	154
Balance Beams .....	136	Challengers® Tot Lot .....	113	Hat Shade .....	200
Balance Trax .....	136	Challengers® Trailblazer w/ Shade .....	85	Heavy Duty Swings .....	133
Ball Maze Insert .....	197	Challengers® Tree Frog Forest .....	81	Hex Cabana Roof .....	200
Bambino Kiddie Corner .....	106	Challengers® Triplex .....	112	Home Dome .....	138
Bambino Playville .....	106	Challengers® Up & Over .....	88	Hopscotch Climber .....	182
Barriers .....	198	Challengers® Vortex .....	124, 169	Horizontal Spiral Ladder .....	186
Beanstalk Climber .....	182	Challengers® Zelda's Fortress .....	110	Horn Panel .....	193
Bell Half Panel .....	192	Chime Banner .....	193	Hypar Shade .....	200
Bell Panel .....	193	Chime Panel .....	193	Inclined Cliff Hanger® .....	180
Bench Boulder .....	150	Chinning/Turning Bar .....	186	Inchworm Climber .....	155
Benches .....	164	Classic Spring Riders Sidewinder Cycle .....	128	Infant Fun Center .....	98
Bernie Bus .....	128	Classic Standard Swings .....	132	infiNET™ INET-1700 .....	104
Bing Boing .....	126	Climbing Squares .....	102-102, 180	infiNET™ INET-1810 .....	63
Black Bear Tunnel Climber .....	154	Climbing Squares Cliffs .....	103	infiNET™ INET-2200 .....	64
Blue Butterfly Climber .....	155	Climbing Squares Hillocks .....	103	infiNET™ INET-2205 .....	63
Boulder Hill Slide .....	134	Climbing Squares Knobs .....	103	infiNET™ INET-2210 .....	64
Boulder Ropes .....	151	Coated Decks .....	198	Jumble Gym .....	146
Bounce Button .....	136, 170	Coated Oval Crawl Tube .....	189	Jungle Rock Climber .....	155
Bouncing Drawbridge .....	169	Color .....	204-205	Jungle Rock Link .....	155
Bow Climber .....	179	Components .....	166-200	KaleidoBarrier .....	199
Branch Out® Adventure Grove .....	174	Concerto™ .....	120-121	KaleidoClimber .....	182
Branch Out® Anchor .....	174	Cone Spinners .....	123	KaleidoCrossing .....	187
Branch Out® Belt Connector .....	175	Construction Insert .....	197	Kinetic Flag .....	200
Branch Out® Cal's Place .....	73	Converge .....	187	Kinetic Topper .....	200
Branch Out® Cargo Net .....	175	Coral Reef Climber .....	154	KPE: Kid Powered Energy .....	191
Branch Out® Forest Hamlet .....	71	Corrugated Peak Roof .....	200	Ladybug Climber .....	154
Branch Out® Gateway .....	104, 174	Cosmic Warp .....	146	Ladybug Hill Tunnel Climber .....	155
Branch Out® Hammock .....	175	Counting Insert .....	197	LifeTrail® .....	160-161
Branch Out® Pedestal .....	175	Cozy Cocoon™ .....	125	Lilly Pods .....	187
Branch Out® Rope Bridge Connector .....	174	Crawl-Thru Panel .....	195	LiveWire Zip Line™ .....	131
Branch Out® Trunk w/Fabric Canopy .....	175	Crazy Bones Bridge .....	188	Log Crawl .....	152
Branch Out® Trunk w/Perf Metal Shade .....	175	Critter Crossing™ .....	170	Log Hop .....	152
Branch Out® Twisted Net Connector .....	175	Cruise Line™ .....	131	Log Pillars .....	152
Branch Out® Whistle Stop .....	71	Deck-to-Deck Climber .....	187	Log Steps Climbers .....	155
Branch Out® Zig-Zag .....	175	Deck-to-Deck Rope Bridge .....	187	Log Tube .....	135
Brig Panel .....	190	Deep Rung Arch Climber .....	183	Loopy Whoop .....	125
Bridges .....	188	Denali Net .....	143	Lumberjack Hollow Tunnel Climber .....	155
Bubble Panel .....	195	Denali Net Bridge .....	187	Magnifying Panel .....	191
Bugs Half Panel .....	192	Disco Spinner .....	199	Maze Half Panel .....	192
Bunny Climber .....	154	Door Panel .....	194	Mighty Descent .....	172
Butterfly Climber .....	138	Driver Half Panel .....	192	ModPods™ .....	105, 144, 176
Cabana Roof .....	200	Driver Panel .....	194	Monorail .....	131, 169
Camber Half Square Roof .....	200	Drop Zone Tower™ .....	169	Moon Rock Climber .....	146
Camber Hex Roof .....	200	Drum Cannon Panel .....	190	Move It Insert .....	197
Campground .....	114	Drum Panel .....	193	Mushroom Path Stepper .....	155
Canyon Crossing .....	187	Drum Set .....	198	Nacia .....	14-15, 140
Castle Arch .....	200	Duo Seesaws .....	127	Nature Hunt Panel .....	191
Castle Boulder .....	150	Early Childhood Playgrounds .....	90-115	Nature-Inspired Components .....	152, 178
Castle Treasure Hunt Panel .....	190	Early Childhood T-Swing .....	132	Nautical Porthole Panel .....	190
Castle Wall Climber .....	179	ENERGI® .....	156-158	Nautical Sail .....	200
Castle Window Barrier .....	190	EZ-Digger .....	139	NEOS® 360 Accessible .....	118
Catacombs Insert .....	197	Find The Way Home Panel .....	195	NEOS® 360 Original .....	118
Catwalk .....	188	Fire Rings & Grills .....	165	NEOS® Arc .....	119
Challengers® Aanyah's Adventure .....	88	FirstPlay™ Infant Fun Center .....	98	NEOS® Wall .....	121
Challengers® Adventure Mountain .....	80	FirstPlay™ Toddler Design #3 .....	99	Nucleo .....	126
Challengers® Ahoy Matey .....	77	FirstPlay™ Toddler Design #5 .....	99	Nuvo™ 360° Spiral Slide .....	134, 171
Challengers® Amelia's Expedition .....	87	FirstPlay™ Toddler Design #7 .....	99	Nuvo™ Curvy Climber .....	181
Challengers® Camp Conifer .....	74	FirstPlay™ Toddler Design #8 .....	99	Nuvo™ Double Glide Slide .....	171
Challengers® Diana's Dreamland .....	114	Fitness & Wellness Systems .....	156-161	Nuvo™ Loop Climber .....	187
Challengers® Fort Twist .....	114	Flex Tread Climbers .....	182	Nuvo™ Roof .....	200
Challengers® Geo Mountain .....	113	Flower Climber .....	138	Nuvo™ Swirl Roof .....	200
Challengers® GeoScramble .....	85	Fossil Jam .....	153	Nuvo™ Transfer Station .....	198
Challengers® Hap's Happening .....	88	Fractal Net .....	59	Nuvo™ Twist Climber .....	181
Challengers® Hattie's Hideout .....	88	Freddy Firetruck .....	128	Oval Crater Arch .....	185
Challengers® Jack's Journey .....	86	Freestanding .....	116-155	Oval Crater Wall .....	185
Challengers® Jolly Roger .....	111	Freestanding Passage Adventure Tube .....	135		

Overdrive.....	124	Rope Ladder.....	183	Tower Steel Climber.....	183
Overhead Ladder w/ Parallel Bars.....	186	Rope Link.....	185	Transfer Station.....	198
Parallel Bars.....	136	Rope Net Climber.....	183	Transition Climber.....	187
Perforated Steel Carnival Roof.....	200	Round-About.....	186	Treasure Tumble Panel.....	195
Picnic Boulder.....	150	Rumble Seat Slide.....	134, 173	Tree Climber.....	183
Picnic Tables.....	164	Rushmore™.....	182	Tree House Barrier.....	191
Play Shade.....	165	Sand & Water Table.....	139	Tree House Climber.....	179
PlayCubes®.....	14-15, 55-59, 104, 145	Scavenger Hunt Panel.....	195	Tree House Doorway.....	191
Playdozer.....	139	School-Age Playgrounds.....	38-79	Tree Log Climber.....	155
PlayExpress.....	139	Sculpted Play Elements.....	154-155	Trike Path Signs.....	95
PlayForm 7®.....	60-61	Seesaws.....	127	Triple Shoot-Out.....	137
Playground Gallery.....	22	Shade Canopy.....	200	Tripple Racer Slide™.....	173
Playmakers® Abigail's Maze.....	78	Shifting Sands Insert.....	197	Tubes.....	135, 189
Playmakers® Aria's Retreat.....	79	Sidewalk.....	137, 170	Tube Slide.....	171
Playmakers® Claire's Climb.....	81	Silo Climber.....	181	Tucson Turtle Climber.....	155
Playmakers® Cooper's Corner.....	107	Single Post Swing w/Toddler Beam.....	132	Twist 'N Twirl™.....	186
Playmakers® Cubes of Denali.....	79	Site Amenities.....	163-165	Twist and Shout Slide.....	134, 172
Playmakers® Cubic Knot.....	83	Sky Rail.....	168	Twisted Steel Climber.....	181
Playmakers® Dynamic Rays.....	83	Skylight.....	13, 200	U-Bounce.....	170
Playmakers® FUNderstorm.....	86	Sky Swivels.....	186	Unity®.....	132
Playmakers® Imagination Station.....	47	Sky Towers®.....	18-19, 38-43	Unity® Basket Swing.....	132
Playmakers® Lookout Point.....	89	Sky Towers® Crimson Sky.....	53	Unity® Connect.....	66-69
Playmakers® Lydia's Rainbow.....	53	Sky Towers® Emerson Heights.....	51	Unity® Dome.....	142
Playmakers® Misty Monarch.....	82	Sky Towers® Hannah's Hideaway.....	50	Unity® Dome Sensory Connections.....	142
Playmakers® Monkeying Around.....	53	Sky Towers® Jude's Tower.....	52	Unity® Hoopla Swing.....	132
Playmakers® Monster Mash-Up.....	81	Sky Towers® Toula's Tower.....	51	Unity® Large Canopy.....	142
Playmakers® Orchard.....	73	Slide-A-Side.....	171	Unity® RockR.....	126
Playmakers® Raelyn's Oasis.....	107	Slides.....	171-173	Unity® Slide Climber.....	134
Playmakers® Superhero.....	88	Slide-n-Learn Panel.....	195	Unity® SpinR 2 Seats.....	29, 122
Playmakers® Wavescape.....	82	Sliding Pole.....	29, 173	Unity® Steppers.....	136
Playseat.....	199	Sling Seat.....	36, 199	Unity® Teeter Tunnel® w/Perf Top.....	127
PlaySimple® Eagle Summit.....	89	Slither Slide.....	172	Unity® Web.....	143
PlaySimple® Lookout Point.....	89	Slither Slide Arch.....	185	Upper Silo Climber.....	180
PlaySimple® Mega Fun Station.....	115	Solar Climber.....	180	Vaquero.....	131
PlaySimple® Mega Tunnel Junction.....	89	Solar System Half Panel.....	192	VertiClimber.....	181
PlaySimple® Mighty Fun Mountain.....	115	Spin Central.....	125, 170	Vortex.....	124, 169
PlaySimple® Rock-N-Slide.....	89	Spin Cup.....	125	Vine Climber.....	179
PlaySimple® Simply Play.....	115	Spin Racer Panel.....	194	Walk the Plank.....	169
PlaySimple® Tunnel Junction.....	115	Spinami.....	124	Warranty.....	201
PlaySoleil™.....	18, 200	Spintastic.....	125	Warm-Up Equipment.....	159
PlayTown™ Butterfly Climber.....	36, 138	Spiral Climber.....	183	Wave Rider Seesaw.....	126
PlayTown™ Butterfly Garden.....	97	Spring Mates®.....	128	Wear Mat.....	159
PlayTown™ Chatterry.....	92	Spring Riders.....	128	Whale Climber.....	154
PlayTown™ Community Helpers w/ Tunnel.....	92	Stainless Steel Slide.....	173	Whale Tail Climber.....	154
PlayTown™ Emily's Playhouse.....	96	Stairs & Ladder.....	198	Wheelchair Ramps.....	198
PlayTown™ Flower Climber.....	138	Stationary Buttons.....	137	Whimsy Wheel Panel.....	194
PlayTown™ Garden Crawl Tunnel.....	92	Steel Curve Climber.....	180	Whirl-a-Round.....	122
PlayTown™ Garden Sensory Wall w/ 2 Inserts.....	92	Steering Wheel.....	199	Whirligig.....	125
PlayTown™ Gas Station.....	95	Steering Wheel Half Panel.....	190	Whirlwind Climbers.....	146, 180
PlayTown™ Music Store.....	95	Step Around.....	199	Wide Glide Slide.....	172
PlayTown™ Nature Station.....	95	Stepped Platform.....	198	Wildwood Climber.....	179
PlayTown™ Oscar's Farm.....	96	Stern Climber.....	179	Window Panel w/Push Clicker.....	194
PlayTown™ Playground.....	95	Straight Horizontal Loop Ladder.....	186	Window Planter Panel.....	191
PlayTown™ Playhouse.....	92	Stretch & Go Arm & Shoulder Circles.....	149	Zig Zag Slide.....	172
PlayTown™ Riley's Rescue.....	97	Stretch & Go Recumbent Bike.....	149	ZoomTrax.....	130
PlayTown™ Silly Tree.....	92	Stretch & Go Shoulder Slide.....	149		
PlayTown™ Toll Booth.....	95	Stretch & Go The Twister.....	149		
PlayTown™ Traffic Light.....	92	Stone Pillars.....	152		
PlayTown™ Truck.....	92	Storefront Panel.....	195		
PlayWood™ Arch Bridge.....	188	Summit Climbers.....	146		
PlayWood™ Climber.....	179	Sunken Treasure Hunt Panel.....	190		
PlayWood™ Barrier.....	191	Super Dome.....	146		
PlayWood™ Peak Roof.....	200	Swing Along.....	133		
PlayWood™ Square Deck.....	198	Swing Along Seat.....	123		
Post Mount Bells.....	193	Swirl Saucer.....	125		
Post Tops.....	200	T-Rex.....	153		
Post w/Ladder Climber.....	183	Tactile Insert.....	197		
Pretend Play Panels.....	195	Telescope.....	198		
Pufferfish Tunnel Climber.....	155	Tetherball.....	137		
Pup Tent Climber.....	152	The Quad Junction.....	184		
Quattro Seesaws.....	127	The Tri-Junction.....	184		
Quito Climber.....	12-13, 141	Themed Adventure Tubes.....	125		
Rainbow Insert.....	197	Themed Flags.....	200		
Raptor Rock Head.....	153	Themed Slither Slide.....	172		
Raptor Rock Tail.....	153	Themed Spiral Slide.....	172		
Receptacles.....	165	Tic-Tac-Toe Panel.....	194		
Replacement Parts.....	205	Timber Stacks™ Albany.....	149		
Revo.....	124	Timber Stacks™ Eugene.....	149		
Rhythm Wall.....	138	Timber Stacks™ Longview.....	149		
Ribbon Climber.....	182	Timber Stacks™ Macon.....	149		
Ridge Boulder.....	150	Timber Stacks™ Mount Vernon.....	148		
Ripple Bridge.....	198	Timber Stacks™ Olympia.....	149		
Rock Climber.....	33, 180	Timber Stacks™ Salem.....	148		
Rock Log.....	152	Timber Stacks™ Spokane.....	149		
RockBlocks®.....	147, 177	Timber Trail Bridge.....	188		
Rocky Ridge Climber.....	180	Tire Swings.....	133		
Roller Slither Slide.....	172	Toss-Up.....	137		
Rope Ascension.....	183	Tower Boulder.....	150		

# The Perfect Pigment

## Rotomolded Colors

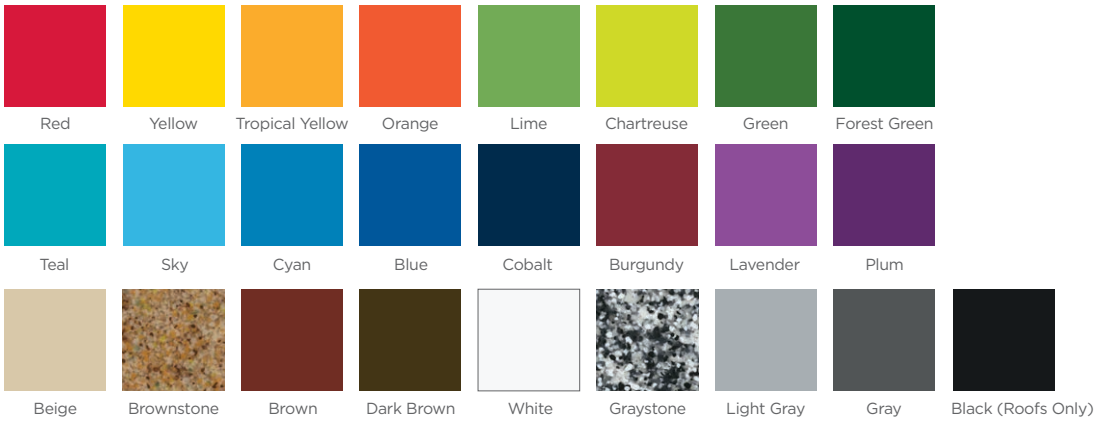

## Component & Post Colors



## 1-Color Sheet Plastic

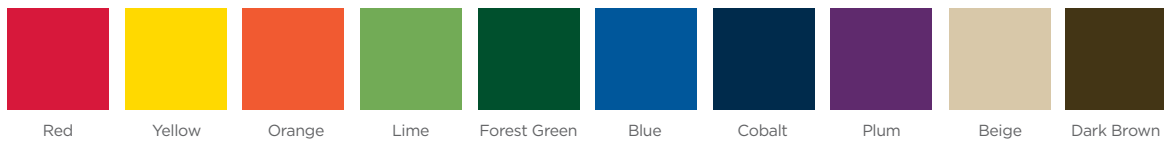

## 2-Color Sheet Plastic



Colors are subject to change without notice. Color swatches are for reference only. For accurate color samples and the most up-to-date specifications consult your local representative. Playworld uses high quality materials and state-of-the-art manufacturing processes. Commercial playgrounds and products are subjected to years of environmental and solar exposure. Such extreme exposure takes its toll on paints and pigments, and all colors will fade over time. Playworld does not warrant against color fading or discoloration. It is important to properly maintain your playground to ensure its longevity. Depending on environmental conditions at your location, the installation of fabric shade structures may help to delay fading and discoloration.

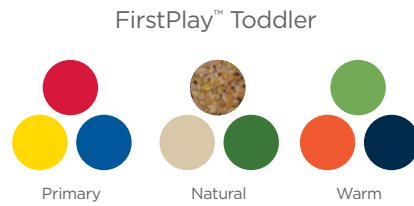

## Site Amenities Colors

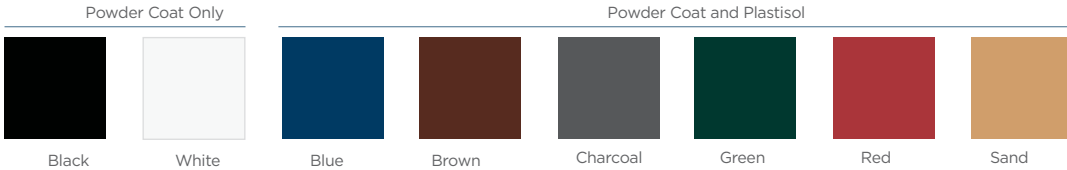

## Shadesure™ Fabrics PASSES: NFPA 701 | ASTM-E84



## Colourshade® FR Fabrics PASSES: NFPA 701 | ASTM-E84 | OSFM TITLE 19

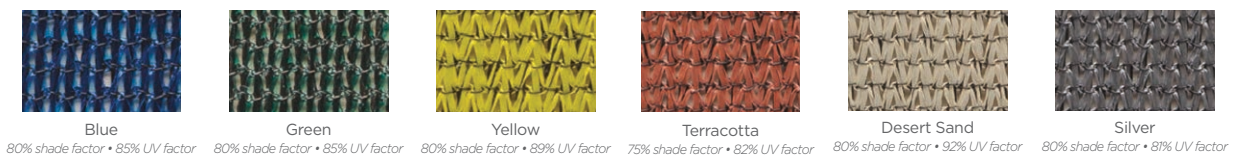

## Plastisol Coating Colors

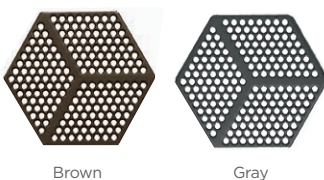

## Boulders Colors

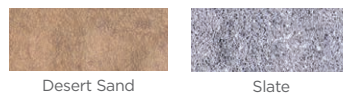

## Rope Colors



## Rapid Response Maintenance Parts Program

Your purchase of a Playworld playground means you are receiving the highest quality product in the industry. With that comes superior service and support. If, during the life of your playground, you need to replace a part, your need is our top priority. You can expect a timely response after you submit your request via one of these methods:

[Playworld.com/Parts](http://Playworld.com/Parts)

Phone: 800.233.8404 or +1.570.522.9800

