

PRODUCT CATALOGUE

world leader in forward-thinking
aquatic play solutions

2023



WATERPLAY®





CONNECTING THE WORLD THROUGH **PLAY.**

The joy of play brings people and neighbourhoods together and makes the planet more livable and socially just. Be a part of the movement toward a healthier, happier, global community by unleashing the exhilarating potential of aquatic play for developing minds, thrill seekers, budding explorers and the young at heart.



CONTENTS

- 4 inspiration
- 12 playPHASE™
- 14 colour
- 18 freestanding aquatic play collections **NEW!**
- 74 titans **NEW!**
- 78 play clusters™
- 80 discovery play
- 86 ground sprays & playable fountains **NEW!**
- 98 aquatic facility features
- 104 activity towers
- 122 water management solutions
- 130 technologies & materials



18



80



86



98



104

EXPERIENCE THE DIFFERENCE

Your project deserves the best. With over 30 years of experience, Waterplay has helped shape thousands of aquatic play spaces around the world. Our design theory is strict, our quality is unmatched and our products create treasured play spaces that stand the test of time.

SUPERIOR QUALITY

Waterplay strives to deliver the highest standards in the industry through the products that we offer, the people we employ, the in-house procedures we put in place and the partners and suppliers we work with.

EXPERT MAKR TEAMS

Our Waterplayers will guide you through the design process and beyond. Our team of experts is comprised of research and design specialists, engineers, in-house manufacturing and logistics, sales and marketing support, on-site service and training, as well as project support specialists.

CARE VALUES

A belief that every task we undertake deserves the utmost Commitment, is approached with the Attitude that anything is possible, is fueled by teamwork based on mutual Respect and promotes an environment of Equality and collaboration.

ACCOUNTABILITY

As a community-minded company, we know safety is paramount when it comes to the people we love. At Waterplay, we value the confidence you place in us and stand behind all of our products, from concept to completion and beyond.

**OUR PURPOSE IS TO
CREATE A GLOBAL
COMMUNITY CONNECTED
THROUGH PLAY AND
SOCIAL EXPERIENCES.**

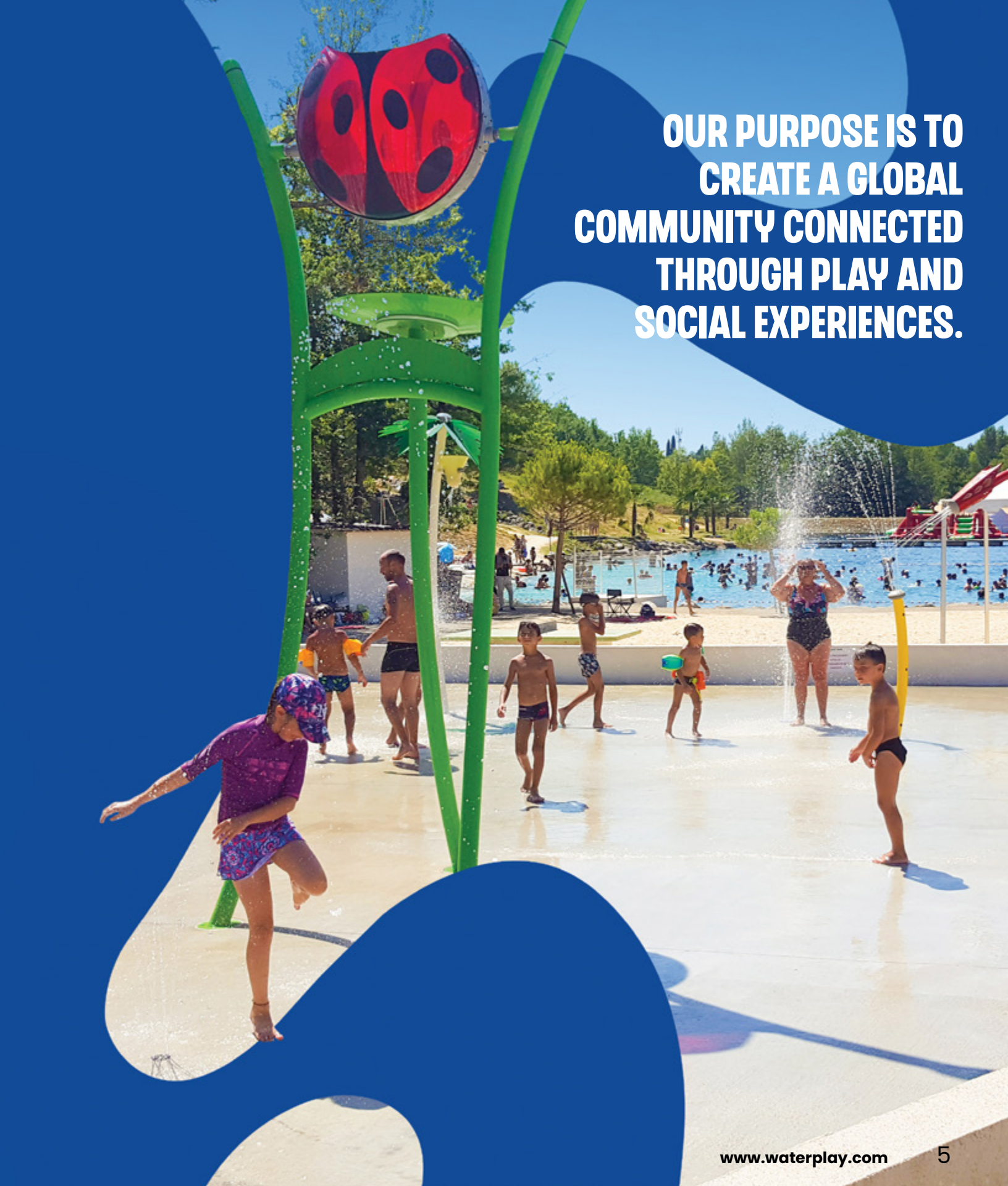



WHERE WE PLAY

AQUATIC SOLUTIONS FOR ANY LOCATION

COMMERCIAL

AQUATIC FACILITIES

water parks

HOTELS & RESORTS

HOLIDAY PARKS

housing developments

entertainment centres

SHOPPING CENTRES

campgrounds

MUNICIPALITIES

PARKS

URBAN AREAS

PUBLIC SPACES

wading pools

community pools

PROVEN DESIGN PHILOSOPHY

Celebrated play spaces have something in common: exceptional products. From their unique functions, materials and technologies to the social experiences they nurture, Waterplay's products bring leading design philosophies to your project.

INCLUSION

Our products are designed for maximum participation. Using universal design principles, ADA and ASTM safety standards, our products create rewarding play experiences for all ages and abilities.

SUSTAINABILITY

Our non-toxic materials and coatings ensure safety for waterplayers and the environment. We are committed to designing products with low flow rates and optimized water use through activation, sequencing and water management best practices.

EXPERIENCE

The true value of play comes from the experiences we have. When play is fun, fresh and exciting for a child, learning flows naturally. Waterplay products focus on collaboration, physical movement, scientific inquiry, make believe and challenging play, supporting the unique development stages of every waterplayer.



PLAY SHOULD BE FREE!

Developing minds and bodies need freedom to test their abilities. Based on the philosophies of unstructured, free play we recommend creating spaces that aren't limited by age or physical ability, but instead thoughtfully created to allow waterplayers to choose their own adventures and distinguish their own boundaries.

Waterplay's three action zones were defined to inspire, embolden and energize waterplayers around the world through environments that foster specific styles of play.

ADVENTURE ZONE

BIG SPLASHES AND NON-STOP ACTIVITY! THE ADVENTURE ZONE IS FULL OF ENERGY AND EXCITEMENT!

Big water effects and continuous action energize the senses and creates excitement

Fast pace encourages quick-thinking and promotes physical movement

Centrally placed and ready for action

EXPLORATION ZONE

SPRAY, DUMP, SPLASH, TEAM UP AND TAKE ON CHALLENGES – THIS UNIVERSAL SPACE INVITES COLLECTIVE FUN!

Play elements and water effects that spark inquiry and encourage physical movement

Multiple opportunities for collaboration and interactive play

Provides a stepping stone between the discovery and adventure areas for a seamless play experience

DEVELOPMENT & DISCOVERY ZONE

A SPACE FOR THOUGHTFUL AND CONTEMPLATIVE PLAY THAT MOVES AT A MINDFUL PACE.

Gentle water effects for reduced stimulation

Cognitive play opportunities facilitate deep learning and flexible thinking for individual and group play

Situated along the outside perimeter and away from the adventure zone for a relaxed play experience

DESIGNING PLAY

FOR OPPORTUNITIES
& POSSIBILITIES

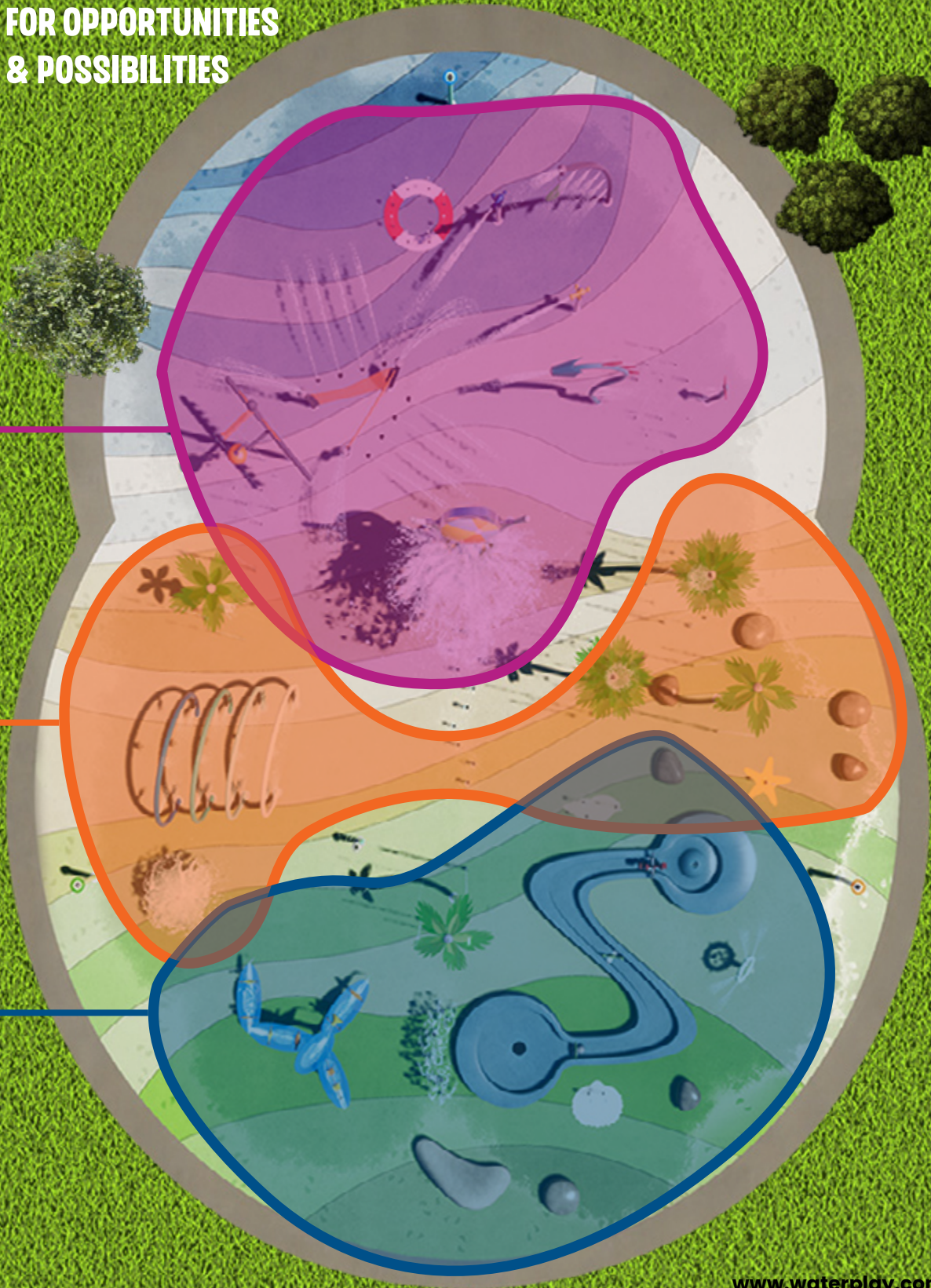

PLAYPHASE™

DESIGN FOR THE FUTURE WITH A SLEEK, FLUSH-TO-GRADE ANCHORING SYSTEM.

Don't limit the possibilities of your next aquatic play project. Phase your installation, switch out spray features or plan for future expansions with **playPHASE™**, a flush-to-grade anchoring system exclusive to Waterplay® Solutions.

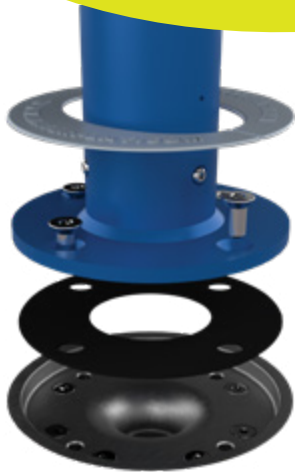

FIND FLEXIBILITY WITH PLAYPHASE

playPHASE™ makes owning a splash pad EASIER! Easier to install, easier to maintain and easier to remove and replace features in future refurbishments.



PLAYPHASE FOOT ACTIVATOR

Hands-free activation perfect for small spaces.



PLAYPHASE BASE CAP

Flush-to-grade playPHASE cap when play features are removed.

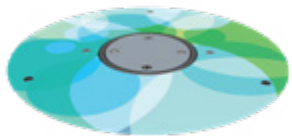

NEW PRODUCT!

PLAYPHASE GRAPHIC PLATE

Waterplay has numerous graphic collection options available. Contact our sales team for more details.

✓ Prepare your project site before the spray features arrive.

✓ Compatible with any Waterplay aquatic feature.

✓ Flush-to-grade design safely conceals hardware.

✓ Works with low, medium and high flow rates.

✓ Sleek and seamless for a flawless play space.

Do you have playPHASE™ bases already installed? Contact our sales team for an evaluation and recommendation for your next Waterplay feature!



WATERFALL 3

✓ No toe guards or dome covers required.

✓ Simplified installation for a perfect concrete pour every time.

PLAYPHASE GROUND & GEYSER SPRAYS

The playPHASE™ Ground & Geyser spray options add playful water action to any space while providing the opportunity to change or phase your sprays throughout its life cycle.

PLAYPHASE GEYSER SPRAYS

Low, medium and high flow geyser sprays.



PLAYPHASE GROUND SPRAY

Interchangeable ground spray. Compatible with 16 different spray nozzles!



COLOUR

STORIES COME TO LIFE
THROUGH COLOUR.





VANILLA



BEIGE



YELLOW



MELON



ORANGE



RED



MAROON



PLUM



PURPLE



ROYAL BLUE



BLUE



TURQUOISE



OCEAN



SAGE



FERN



FOREST



GREY



BROWN



GRAPHITE



WHITE



BLACK

Deep blues and gentle greens, sharp reds and muted creams, each of these colours can align with your surrounding landscape, facility, adventure or moment in history to help narrate your space design.

Choose from a variety of brilliant Waterplay colour options unique to your project, or choose from one of our carefully crafted pre-set collections.

Designed to withstand the elements, our super durable, lead-free powder coating is built to withstand extreme climate temperatures, moisture and UV exposure.

AQUA-KNOT

Pairing colours can be tricky and choosing combinations that work together effectively is key to the success of your design. By selecting one of Waterplay's harmonized colour collections, you can comfortably reinforce a unified, themed appearance to ensure that your next aquatic play project hits the mark.

PLAYFUL

NATURE

NAUTICAL

URBAN

AQUALUME™

Make a statement in your next design with Waterplay's Aqualume™, an impact resistant and durable polymer that allows the sunlight to pass through for a truly stunning play experience.

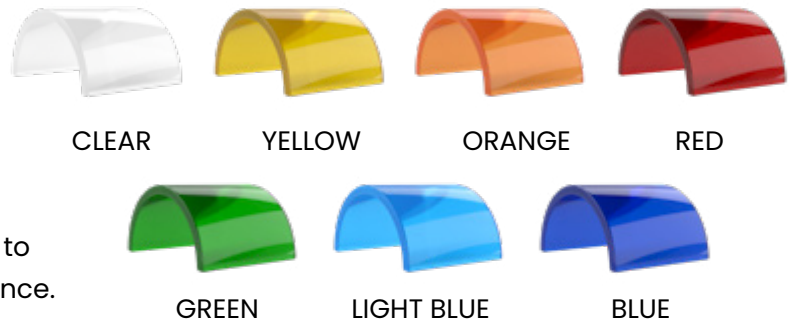

BELL BUCKETS



Waterplay has numerous graphic collection options available. Contact our sales team for more details.

GRAPHIC OPTION SNEAK PEEK

MISTY TWISTY
Create a beach oasis with the **Surf Spray** graphic collection.

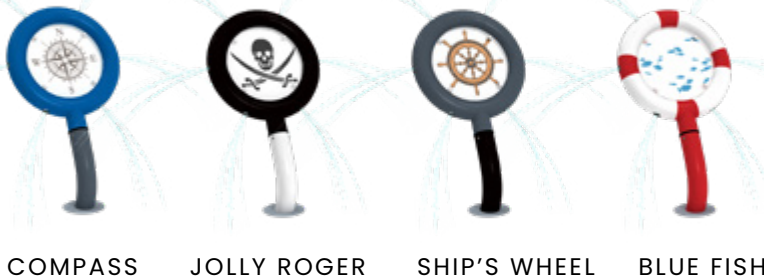

MAGNIF-EYE
The **High Seas** graphics are full of adventure and discovery!

LILY PAD Kaleidoscope
graphics ignite childlike wonder in us all.



FREESTANDING AQUATIC PLAY COLLECTIONS

A great aquatic play space should offer collaboration, physical movement, scientific inquiry, make believe and challenging play opportunities, supporting the unique development stages to every waterplayer.

From spray cannons, to larger-than-life dumping buckets, small splashes and interactive play features, Waterplay provides a wide range of products to complete any community space design, as well as enhance visitor experiences at waterparks, entertainment centres, aquatic facilities, and holiday parks!





KALEIDOSCOPE

collection



KALEIDOSCOPE

collection

COLOUR THEME:



A CHILD'S IMAGINATION
is full of bright colours
and fun shapes. The
Kaleidoscope Collection
takes waterplayers on an
action-packed, playful
adventure through a real life
wonderland of discovery.



**SPLASH
BLASTER**

SOAKERS & SPRAYS

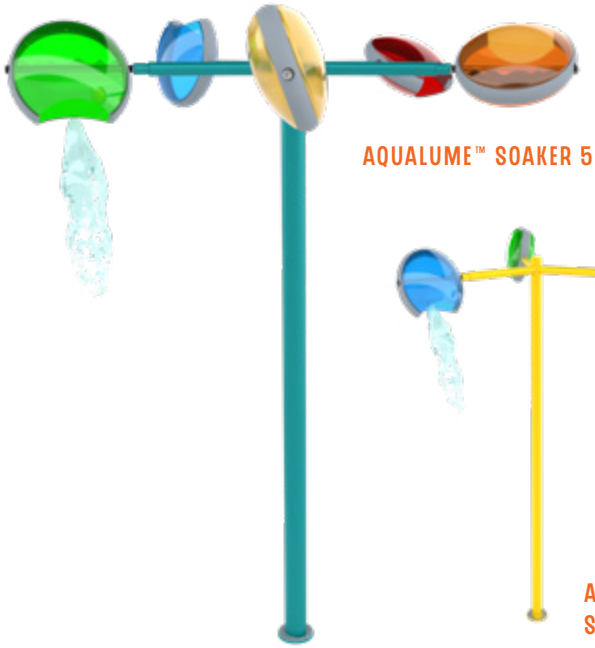

AQUALUME™ SOAKER 5

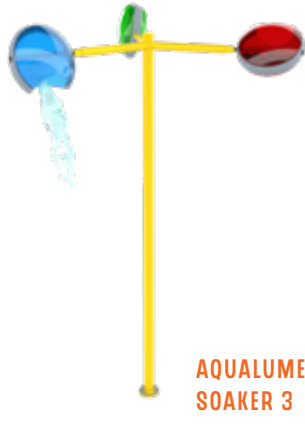

AQUALUME™ SOAKER 3

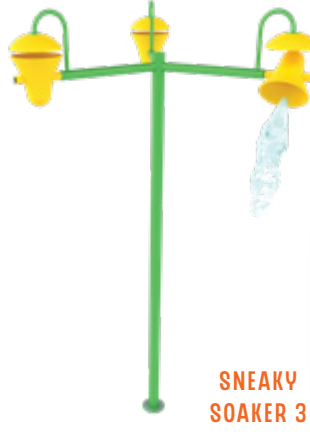

SNEAKY SOAKER 3



SNEAKY SOAKER 5

CANDY CANE



WAVY WAND

SNEAKY SPIN SOAKER 2



360°

SNEAKY SPIN SOAKER 3



SPIN SPLASHER



CANNONS



SPLASH BLASTER

120°

360°



TEAM BLASTER



WOBBLY CANNON



SMALL SPLASHES

U.S.O



MISTY TWISTY



MAGNIF-EYE



FUN-BRELLA

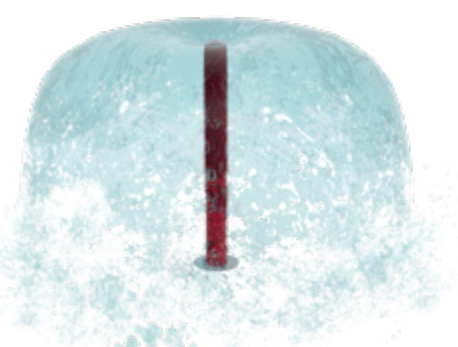

SPINNY SQUIRT



FUN-GUYS

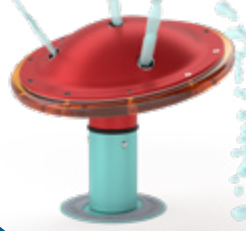

SPINNY SQUIRT





ARCHIE



FROGGIE-O



ARCHES

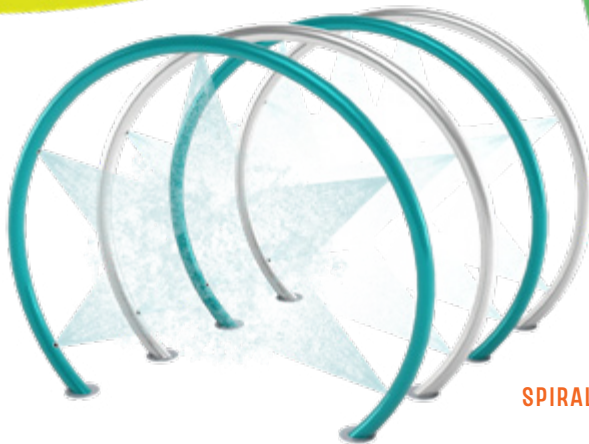

SPIRAL TUNNEL

WATER-O



ACTIVATORS

POWER POST



PLAYPHASE™
FOOT ACTIVATOR



AQUA ARCH

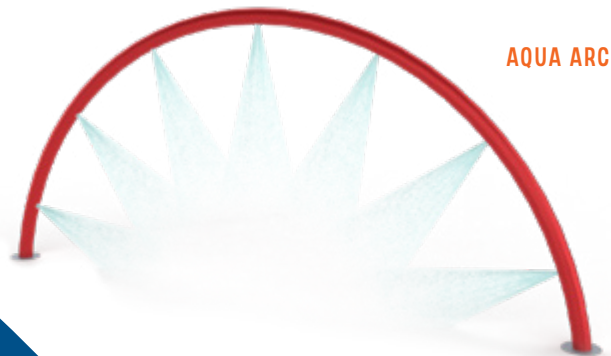

REVOLUTIONS

collection





REVOLUTIONS

collection

COLOUR THEME:



THE REVOLUTIONS COLLECTION

was designed on an axis. Featuring smooth lines, 360° revolutions, spirals and spheres, this stunning group of products and colours unites play with a contemporary design aesthetic.



TWIST N'
SPILL 2

BIG SPLASH!

MEGA SOAKER



SPIN
SPRAY 1



SPIN
SPRAY 2

HELICES

SOAKERS & SPRAYS



NEW!
SLING
SOAKER



BLOOMIN'
SOAKER 2



TWIST N'
SPILL 1



TWIST N'
SPILL 2

U.S.O.

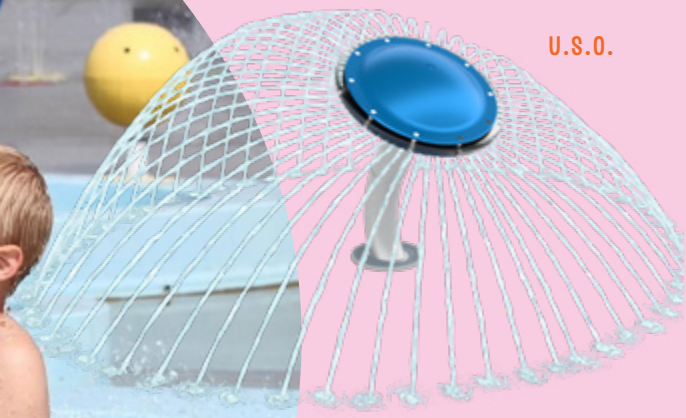

FUN-BRELLA



FUN-GUY 4

SOLIS 36



SMALL SPLASHES

SOLIS 24



SPINNY SQUIRT

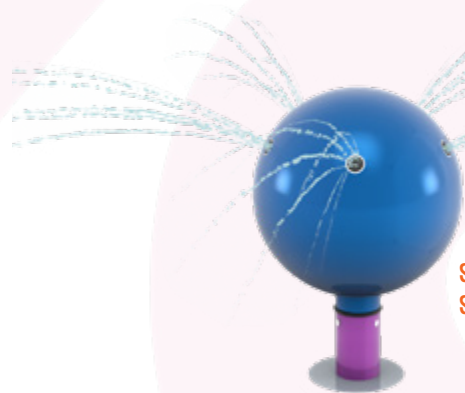

FUN-BRELLA



CANNONS



ACTIVATORS



ARCHES

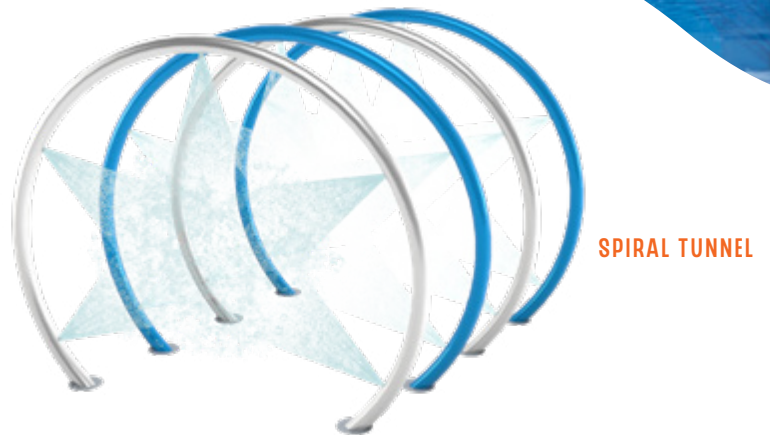

WATER-0





NATURE

collection

NATURE

wildwood collection

COLOUR THEME:



ACCENTS



EMBRACE THE GREAT OUTDOORS

with the Nature Collection. Giant raining leaves, trees, flowers, spraying cat tails and wiggly water cannons are designed to peak the imagination of all waterplayers, young and experienced.



DAISY MAE WINDY



RAIN CAP

RAIN CAP DOTS

TRILLI LILY WINDY

FLORA & FAUNA



RAIN CAP



PAPILLON



DAISY MAE



DAISY MAE WINDY

ACTIVATORS



POWER POST

PLAYPHASE™ FOOT ACTIVATOR





RAIN FOREST

FLORA

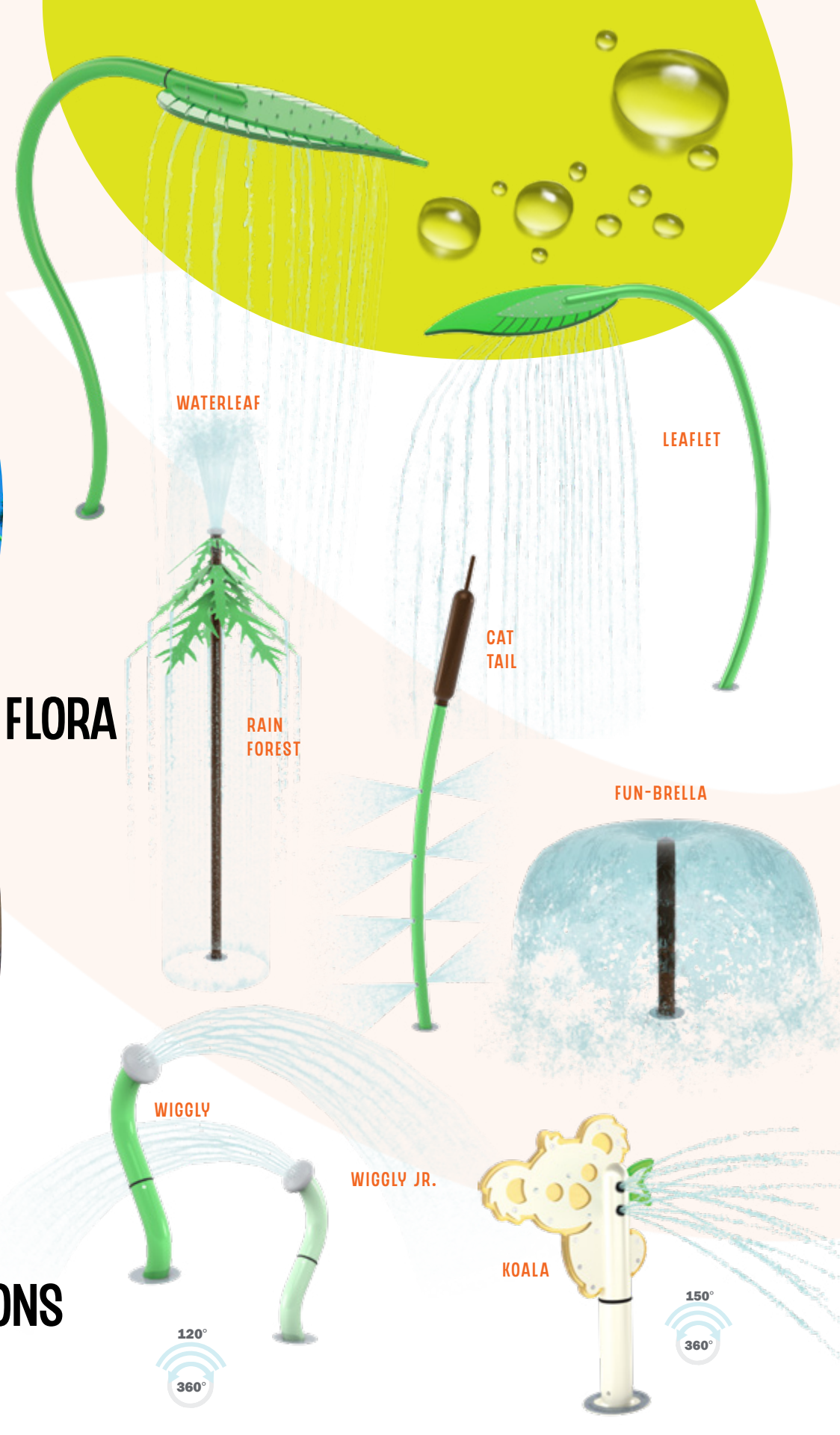

WATERLEAF

LEAFLET

CAT TAIL

RAIN FOREST

FUN-BRELLA

WIGGLY

WIGGLY JR.

KOALA



SNAPPER 1



SLOWPOKE 2



FUN-GUY 2



FLUTTERBY



FUN-GUY 1



SLOWPOKE 1

SMALL SPLASHES

HOPPER 2



FUN-GUY 3



FUN-GUY 4



KOALA

NATURE

ranch collection

COLOUR THEME:



ACCENTS:



WATER
TOWER

ENHANCE
WITH YOUR
GRAPHIC!

CHARGER



WATER
TOWER





POLY PALM WINDY

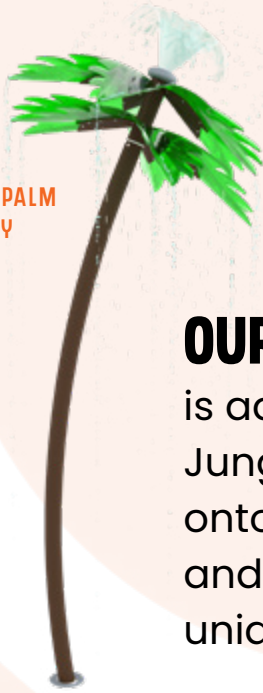

POLY PALM



POLY PALM 5

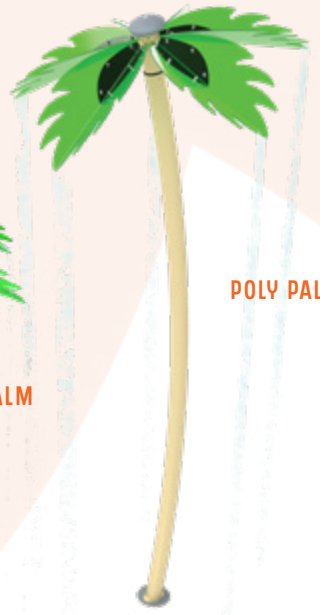

OUR NATURE COLLECTION

is adaptable. Use the Ranch and Jungle themed products to build onto the Wildwood Collection and tell a story that's not only unique, but full of themed fun!

NEW!
SLING SOAKER



GEROME



jungle collection

COLOUR THEME:

ACCENTS:



Oakvale Farm & Fauna World put an end to off-season slumps with a water park that keeps visitors cool year round. Highlighting their wildlife theme with the Wildwood Collection, the splash pad comes alive with water cannon koalas, a spiral tunnel coiled like a python and small features that introduce waterplayers to native critters like kangaroos and wombats.

OAKVALE FARM & FAUNA WORLD
NEW SOUTH WALES | AUSTRALIA
wildlife park





“

We've got visitors traveling three hours each way just to visit our park.

Kent Sansom,
Owner

”





NAUTICAL

collection



NAUTICAL

high seas collection



COLOUR THEME:

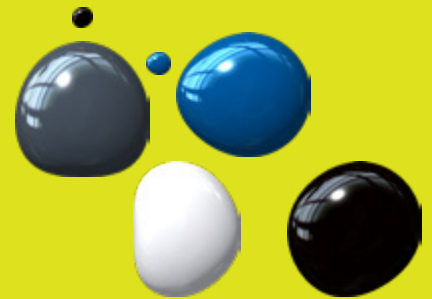

ACCENTS:



ESCAPE THE HIGH SEAS

The Nautical Collection is sure to unleash adventure and courage in waterplayers of all ages and abilities. Brave the open water on the H.M.S. Waterplay, spray the nearest pirate or make friends with the wiggly Octopus!

150°
360°



DOLPHIN



OCTOPUS

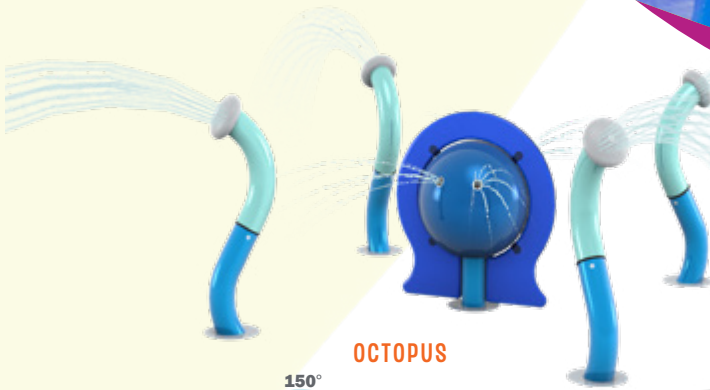

OCTOPUS

SEA CREATURES

150°
360°



SHARK

150°
360°



OGOPOGO

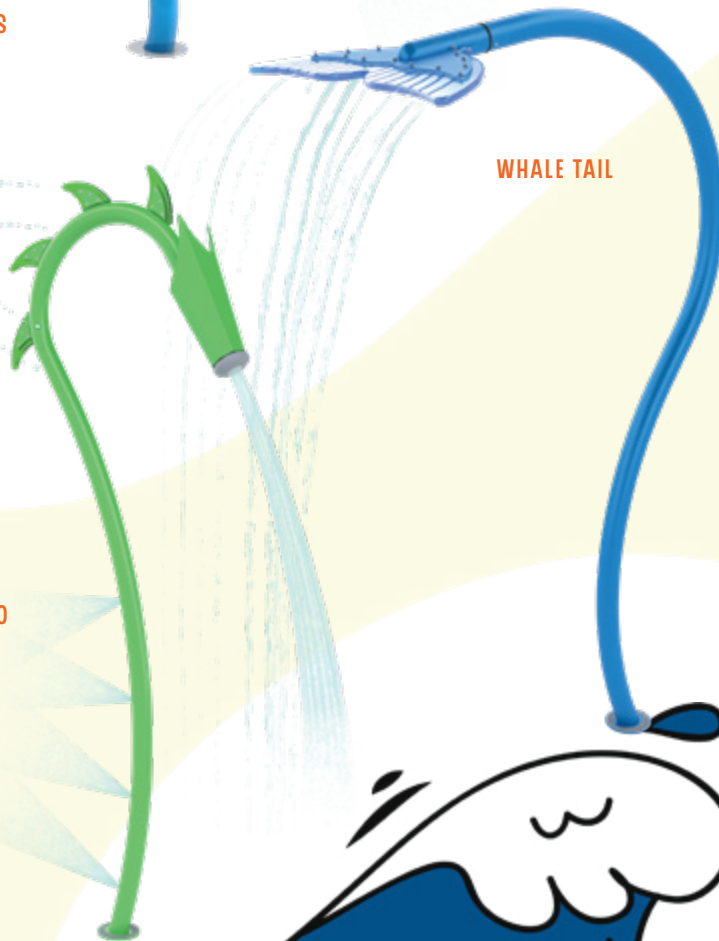

WHALE TAIL

OGO



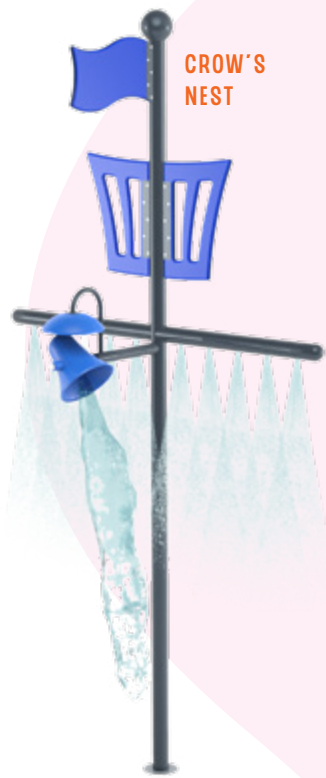

CROW'S NEST

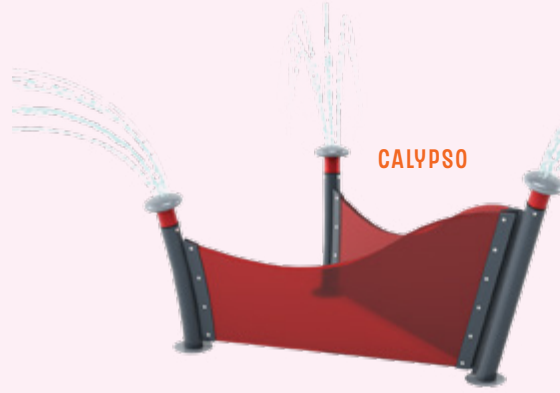

CALYPSO



POLY PALM

SOAKERS AND SPRAYS

FISHIN' POLE

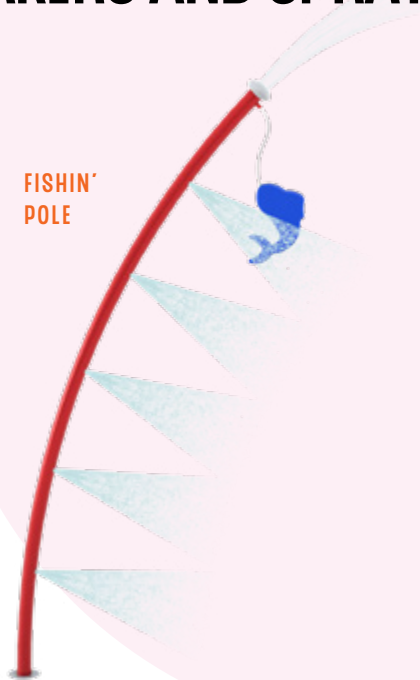

POLY PALM WINDY



SEASTAR



POLY PALM 5



POLY PALM COCO



SEASTAR



MAGNIF-EYE

360°

SNAPPER 2



BLOW FISH



CRABBIE 2



SNAPPER 1



360°



CRABBIE 1

SMALL SPLASHES

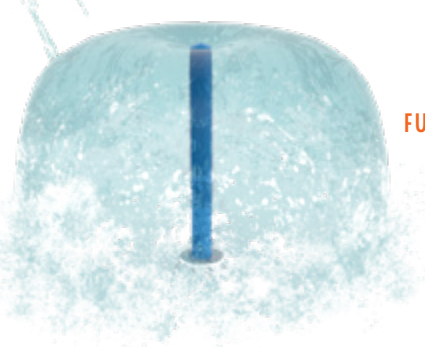

FUN-BRELLA

CANNON



CARRONADE



CARRONADE

ACTIVATORS

PLAYPHASE™ FOOT ACTIVATOR



POWER POST

NAUTICAL

surf spray collection

COLOUR THEME:



ACCENTS:



SOLIS 36

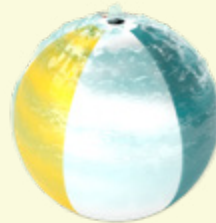

SOLIS 24

BEACH BALLS

POLY PALM 5

Tip: Poly Palms set the scene for a day at the beach.

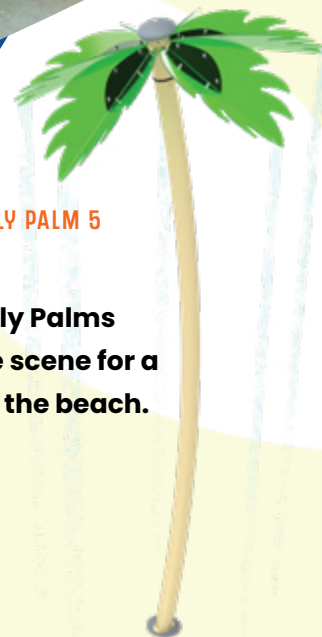



RAIN CAP
UMBRELLA

SNAPPER 2



TURTLE



SPRAYS AND CANNONS

SURF
CANNON

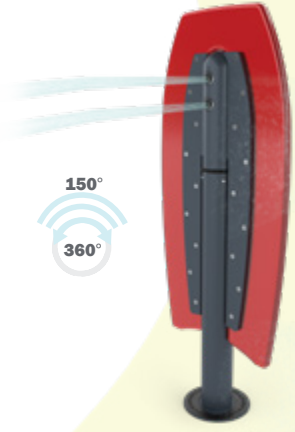

SURFBOARD

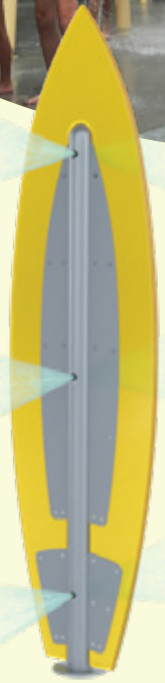

POLY PALM



POLY PALM
WINDY



THE SURF SPRAY COLLECTION

perfectly embodies the serenity and playfulness of the beach. Use these features together with the High Seas Collection to slow down your nautical adventure and create a Zen play space full of surf, sun and fun.

GRASSLANDS

Ehring collection



EHRING COLLECTIONS

A product design collaboration with Markus Ehring, world-renowned public space designer, the Ehring Collections by Waterplay are the perfect balance of play value, beauty, form and function.



GRASSLANDS

Ehring collection



COLOUR THEME:



ACCENTS:



TALL BLADES OF GRASS,

whimsical wildflowers, smooth stones and friendly creatures—the Grasslands Collection brings the wonder and beauty of nature to the play pad.

CRITTER 1



GECKO

COVER THE NOZZLES TO PUSH THE WATER HIGHER!

GROUND SPRAYS



ANTS 3

FROG

GECKO



SOAKERS & SPRAYS

CANNONS

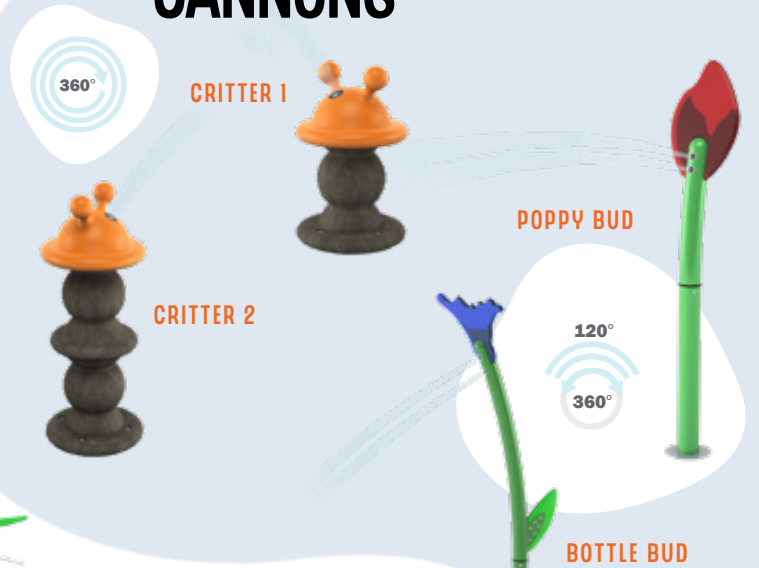

CRITTER 1



POPPY BUD

CRITTER 2



BOTTLE BUD

CHARLOTTE



BLUE BOTTLE



SPARK



DEW DROP

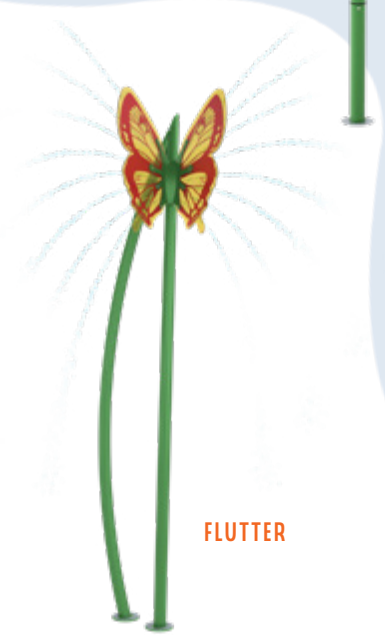

FLUTTER



WILDFLOWERS



CORN POPPY



ANETH BLOOM 1



ANETH BLOOM 3

BIG SPLASH!



LADYBUG SOAKER

ACTIVATORS



SPROUT

PLAYPHASE™ FOOT ACTIVATOR



GRASSES

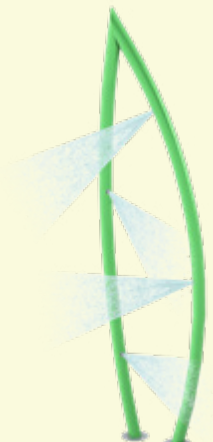

MORNING GRASS 1, 2 & 3

Find your way through giant wild flowers and splashing dew drops at these nature-inspired aquatic play spaces.

Toss in some park-inspired toys and these modern, eco-friendly designs become an attractive public space where communities can gather, relax and connect through play.

BEACH BALL SOAKER

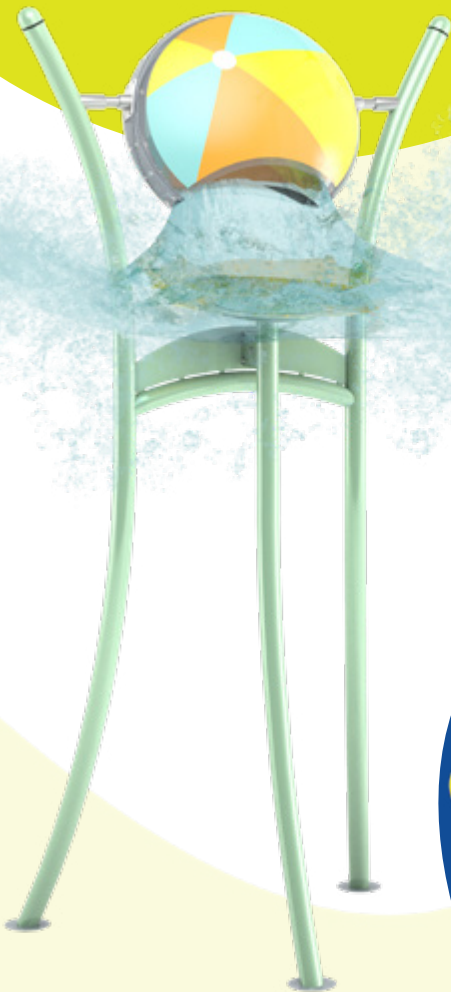

BEACH BALL SOAKER

SHORELINE COLLECTION

WHIRLER
(ACTIVATOR)



KITE



"Thoughtfully selected colour palettes not only **influence the beauty** of the space but also the way people play and interact."

Markus Ehring
Public space designer, Germany

CIRQUE

Ehring collection





CIRQUE

Ehring collection

CAROUSEL
CANNON 2

THE CIRQUE COLLECTION

is designed for collaborative fun. Push, spin, plug and take aim. This troupe of whimsical and looping play features delights waterplayers with a spectacular water show.

COLOUR THEME:



CANNONS NEW!

CADABRA
CANNON

150°
360°

CAROUSEL
CANNON 2

RINGLING

CAROUSEL
CANNON 1
NEW!

ACTIVATORS

RINGMASTER

PLAYPHASE™ FOOT
ACTIVATOR

SMALL SPLASHES

WATCH THE
BUCKET FILL
AND GET READY
FOR THE BIG
SPLASH!

BIG SPLASH!

BIG TOP SOAKER

DJEMBE

BOINGO

LASSO
NEW!

PUSH DOWN AND
WATCH THE NEAREST
GROUND SPRAY
SHOOT HIGHER!

NEW!
POI SPINNER

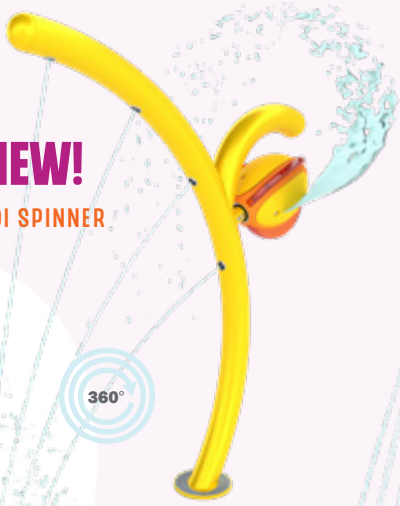

AQUA-KNOT

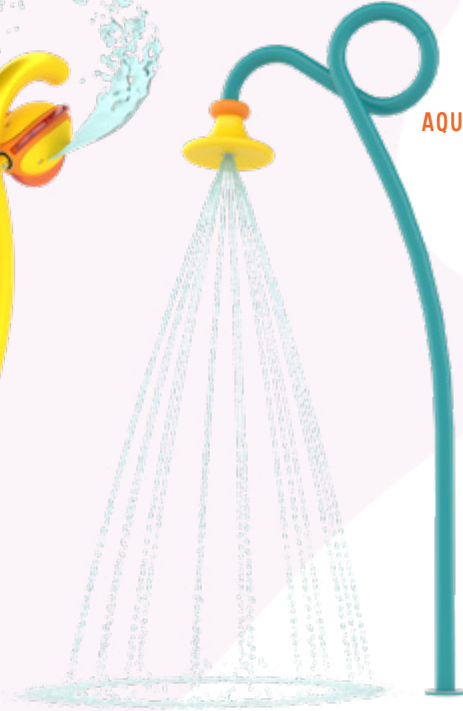

NEW!
AERIAL SPINSTER



NEW!
TWIRL-WHIRL



360°

360°

AQUA-BATIC



SOAKERS & SPRAYS

AQUA-DROP



ENCORE



PARASOL



NEW!
AERIAL SPLASHER

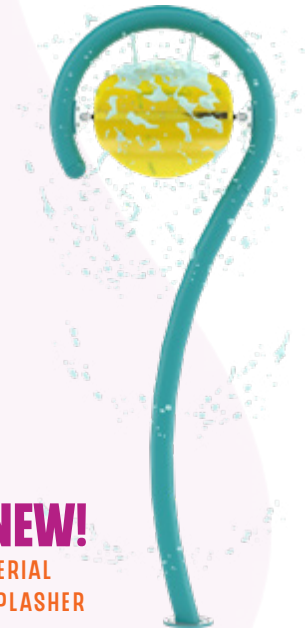

NEW!
AQUA-JUGGLE



waterplay testing facility
SLOSH 3

SOAKERS & SPRAYS



NEW!
SLOSH 1



NEW!
SLOSH 3



ROUE CYR

ARCHES



ROUE CYR



NEW!
HULA-HOOPER



PLAY PALS

collection

Play Pals are an offering of 'must-have' features that energize waterplayers wherever they go!

HOPPER 2



MEGA SOAKER



FISH



FOX



SPIRAL TUNNEL

PLAY PALS

collection

PLAY PALS MOVE

through any collection or play space! Whether you want to add more fun to your Nautical design, or build out a Wildwood adventure, Play Pals fit seamlessly into any space to help tell your story.

TWIN TOT SLIDE



WATER-0

ARCHES

CUSTOMIZABLE WITH A CITY NAME, LOGO, OR SPONSOR RECOGNITION

O-RIGINAL



SPIRAL TUNNEL

WATER-O



SMALL SPLASHES



MISTY TWISTY



SPINNY SQUIRT

FUN-GUY 2



U.S.O.

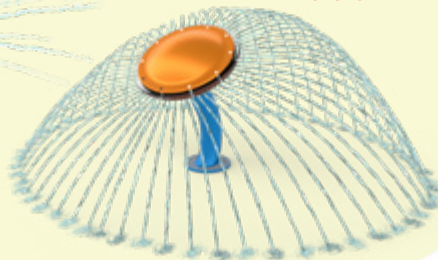

FUN-BRELLA

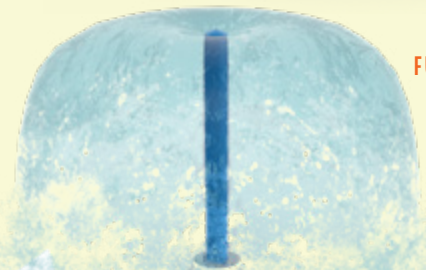



SKIP!

SOAKERS AND SPRAYS



WATER WEAVER 3



WATER WEAVER 1



SPIN!

WATER WEAVER 2



BIG SPLASHES!

MEGA SOAKER



SKY SOAKER



NEW!

SLING SOAKER
OUR MID-SIZED
POWERHOUSE
SOAKER!



CANNONS

ACTIVATORS



POWER POST



TEAM BLASTER



PLAYPHASE™ FOOT
ACTIVATOR



SPLASH
BLASTER





**SNEAKY SPIN
SOAKER 3**



**AQUALUME™
SOAKER 5**

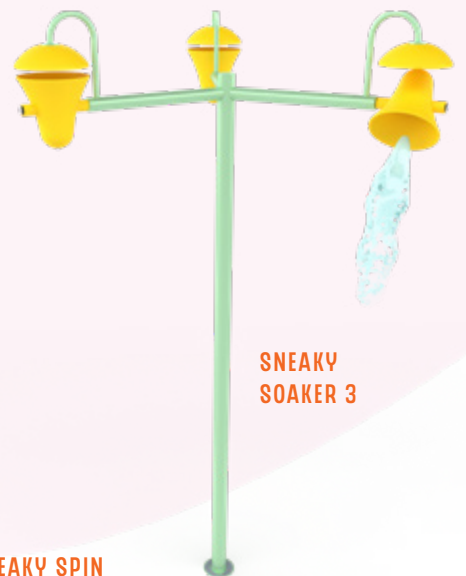

**SNEAKY
SOAKER 3**



**SNEAKY SPIN
SOAKER 3**



**SNEAKY SPIN
SOAKER 2**

SOAKERS AND SPRAYS



**AQUALUME™
SOAKER 3**



**SNEAKY
SOAKER 5**





Perfect for ages 2–6,
Toddler Creatures deliver a
dynamic play experience
with 360° rotation, multiple
water effects AND varying
height options! AWESOME!

PLAY PALS

TODDLER CREATURES

SLOWPOKE I



CRABBIE I



SNAPPER I



WATER FEATURES

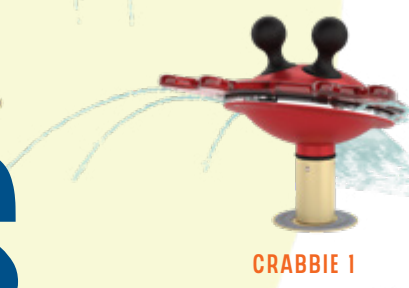

FELLOWS

PLAY PALS

Versatile and customizable with just about any companion shape!

ALL YOU NEED IS AN IDEA!

A collaboration with Markus Ehring



Perfectly sized for smaller Waterplayers, FELLOWS come in a variety of characters for any splash pad design. Need a mascot? We can do that! A bird or a plane? We can do that too.



KOALA

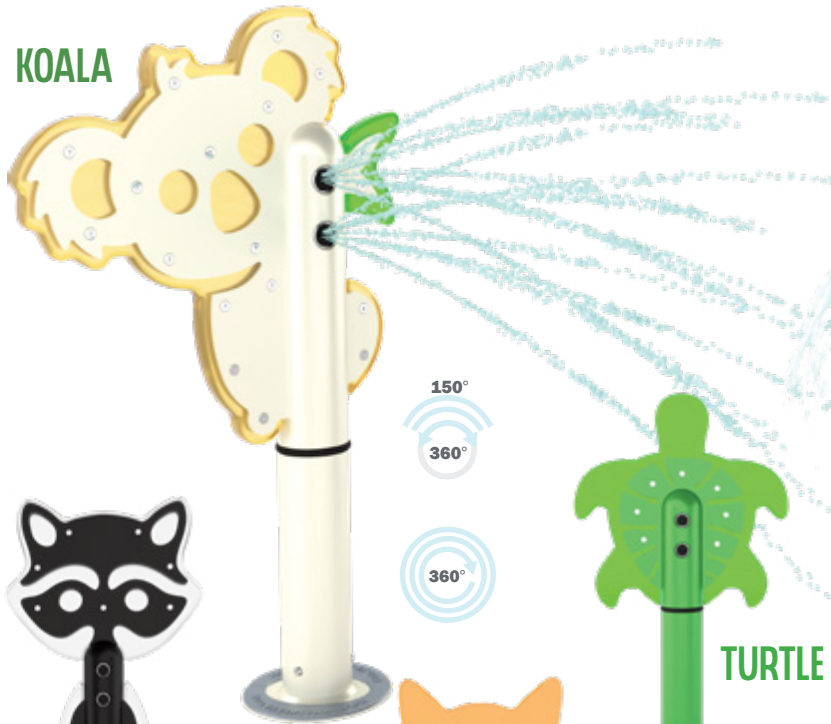

FISH



WHALE



RACCOON



TURTLE



FOX



SHARK!

KANGAROO



OWL



CROCODILE



DOLPHIN



STARFISH

TITANS **NEW!**

Meet Mr. Ribbit, Speed Racer, Bun-Bun and Toro!

Four larger-than-life characters are designed to dominate the splash pad and be the main event of play. **Standing at over 15 feet tall**, with water effects that dump, splash and spray, the Titans can stand alone as the only feature on a splash pad, or fit easily into a larger, dynamic space design.



MR. RIBBIT
15 FEET TALL!

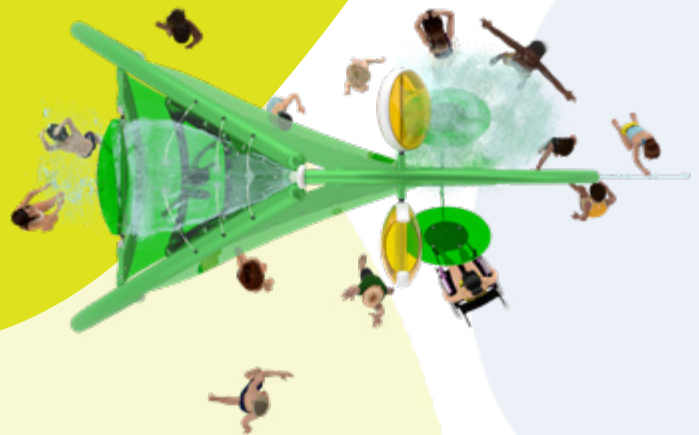

Three connection points for easy, economical installation.



Multiple play points to bring fun to a large group of waterplayers at one time.



Dynamic water effects to capture attention and dynamic play opportunities.



Inclusive design caters to a wide variety of ages and diverse abilities.

MR. RIBBIT

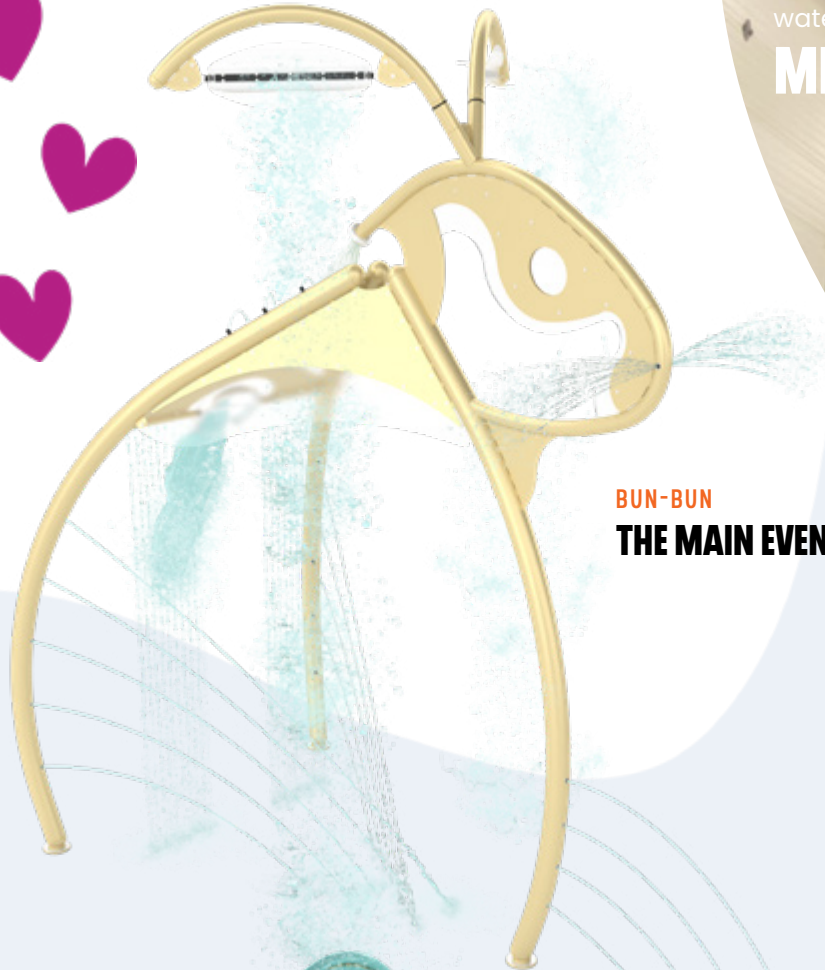

BUN-BUN
THE MAIN EVENT!



SPEEDRACER
DUMP,
SPLASH &
SPRAY!



TORO
DOMINATE THE
SPLASH PAD!

BUN-BUN



MR. RIBBIT





SPEEDRACER



TORO

PLAY CLUSTERS™

VOYAGES PLAY CLUSTERS™

offer an action-packed play solution with a compact footprint to accommodate any space or budget.



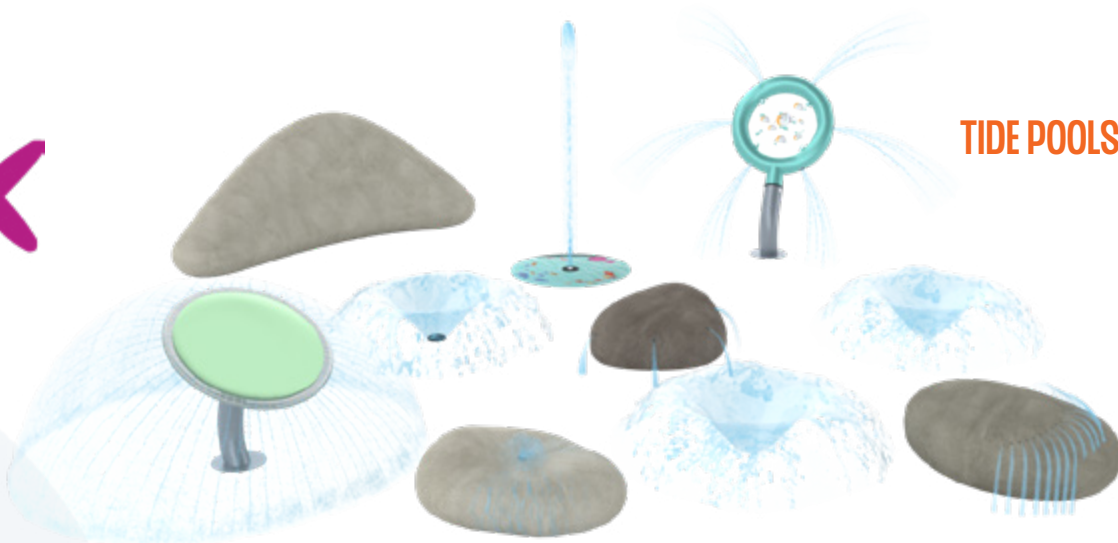

TIDE POOLS

UNCOVER POCKETS OF PLAY

as the tide flows between land and sea. When waters retreat, shallow pools are left between the stones to expose coastal marvels for all to discover.

Encourage specific play styles through clusters of play perfect for any setting.



SERENE STONES

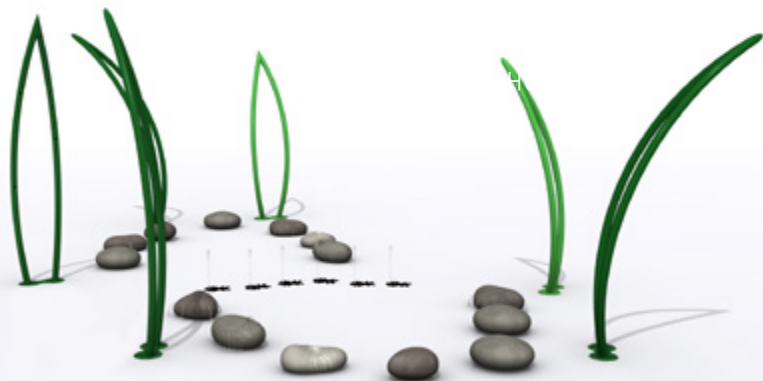

POPPY LABYRINTH



DISCOVERY PLAY



DISCOVERY PLAY

is designed to spark exploration, wonderment, intrigue and discovery. Children of all ages can move, touch and manipulate the flow using interactive weirs that will exercise their minds and problem solving skills.



WATERWAYS

DISCOVERY PLAY

A CASCADING ADVENTURE FOR INQUISITIVE WATERPLAYERS WHO LIKE TO EXPLORE THE DIFFERENT WAYS THAT WATER MOVES.

Guide the water into waterfalls and gullies, through spinning weirs and tipping buckets, across sneaky holes and into whirling basins. Waterways offers a new adventure at every turn.





WATERFALL 1

BLOCK



SPIN!



GULLY



PUSH



WATERFALL 2

PLUG

TIP

REACH



WATERFALL 3



SPLASH

MODULAR DESIGN

Build a unique configuration for any space.

EASY INSTALLATION

One connection point per feature reduces installation requirements and cost.

TURN!

BASIN

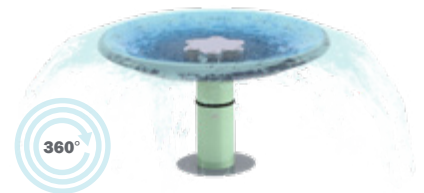

DISCOVERY STREAM



DISCOVERY PLAY
Ehring collection

Inspired by nature, designed for fun—the Discovery Stream is a modular stream bed packed full of fascinating water weirs that challenge the mind and evoke thoughtful play. Perfect for waterplayers of all ages and abilities.



FISH



SEA BLOSSOM

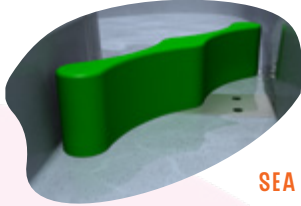

SEA GRASS



WETWELLY



DUCK WHEEL



STOUT MOUSE



This meandering stream invites gentle hands-on discovery, bubbling sprays that add clusters of excitement.

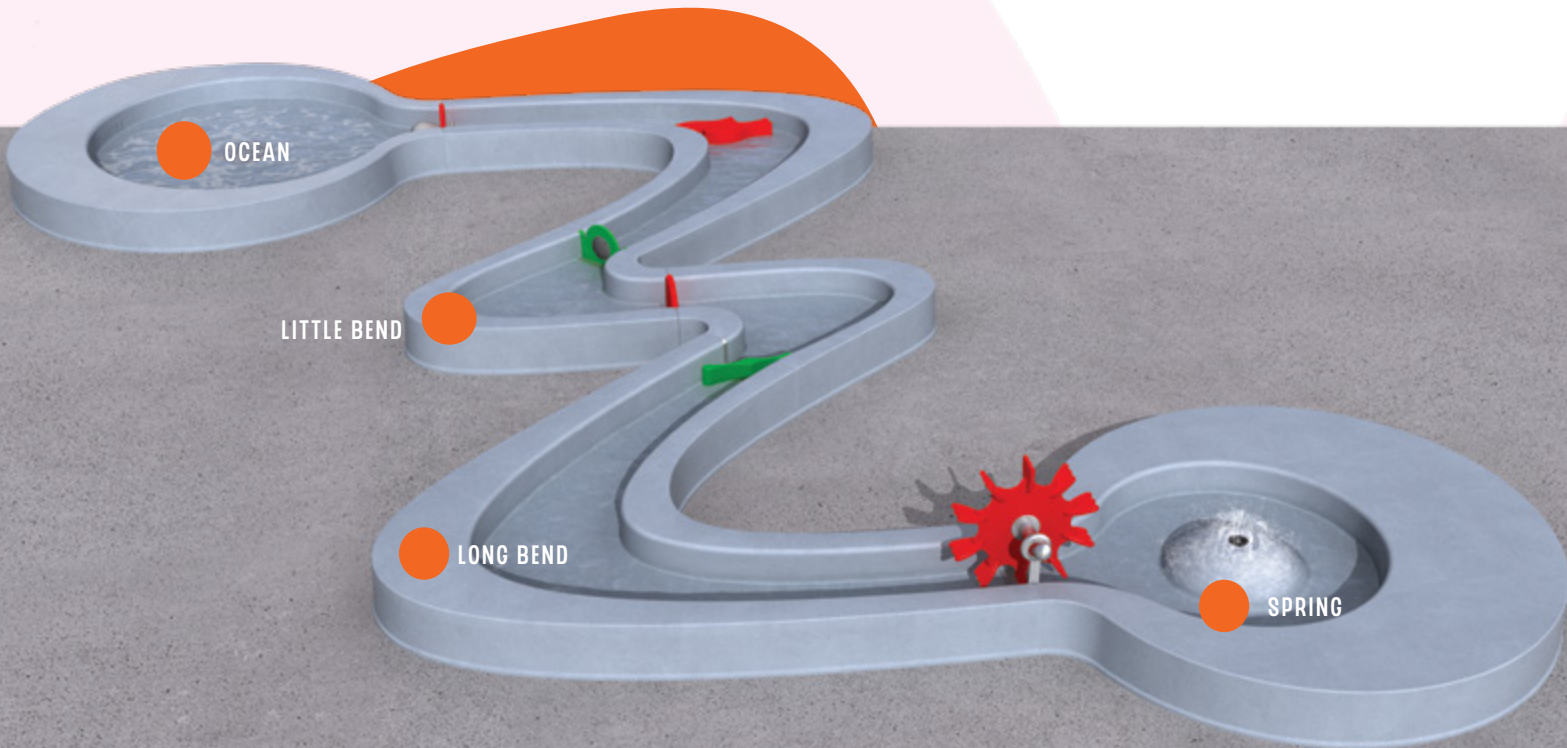

GROUND SPRAYS & PLAYABLE FOUNTAINS





GROUND SPRAYS & PLAYABLE FOUNTAINS



GROUND SPRAYS

are an essential part of every design: use them alone or to complete a design with dynamic spray patterns. Keep the magic flowing after dark with Glow Effects and Luminaries!

THEY GO
ANYWHERE...

**SPRAY
TUNNEL 8**



TUNNELS



SPRAY TUNNEL 4

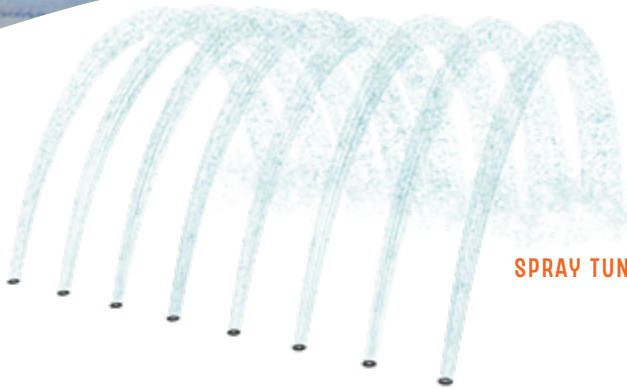

SPRAY TUNNEL 8

CAUSE AND EFFECT

COVER THE NOZZLES TO
PUSH THE WATER HIGHER!

TEAM EFFECT

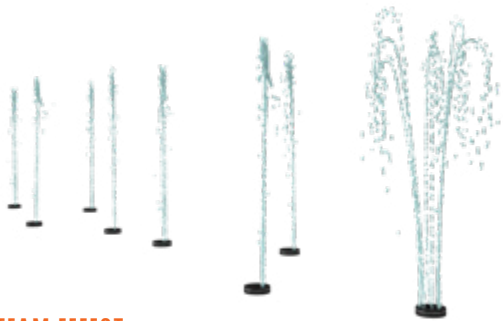

TEAM EFFECT MINI



GROUP VOLCANO

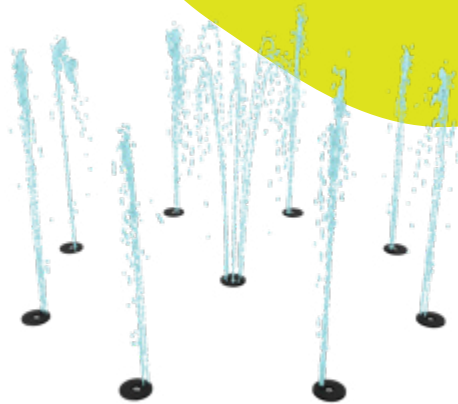



TULIP

CLASSIC SPRAYS

FOUNTAIN MOUNTAIN

GEYSER

MISTY MOUNTAIN

STRAIGHT UP

NEW!

MISTER MISTER

TULIP

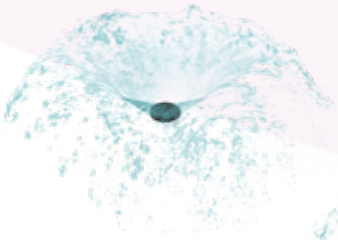

CONFETTI SPRAY



MONSTER 5



SOLO SPURT

GUSHER





MOP TOP

MULTI-DIRECTIONAL

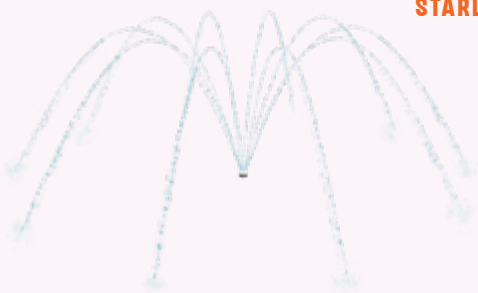

STARLET SPRAY

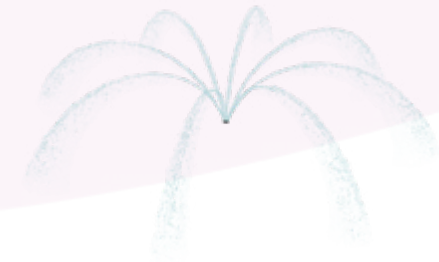

CHARLOTT'E'S WEB

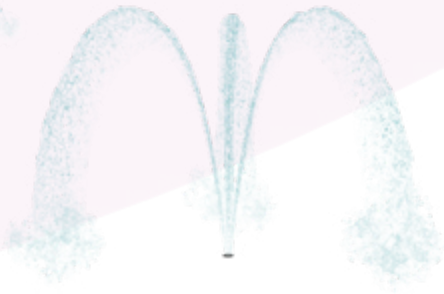

TOWER SPRAY

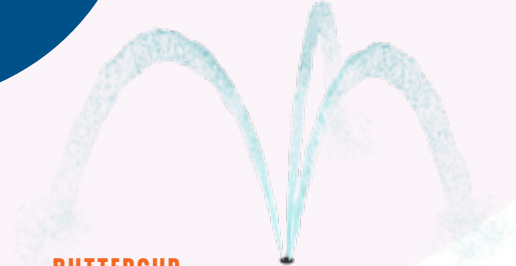

BUTTERCUP

CUSTOMIZABLE



LILY PAD





DOUGHNUT

WATER FORT

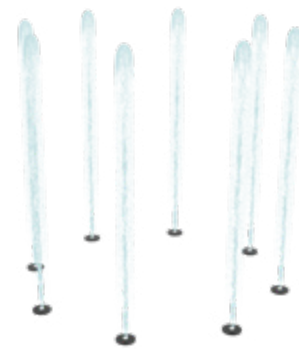

DOUGHNUT

DIRECTIONAL



WAVE



TIDAL WAVE



STEADY STREAM



SPLIT SPURT

DYNAMIC



POP-IT



TILTY POP-IT



PLAYPHASE GROUND SPRAY



PLAYPHASE GEYSER L



PLAYPHASE GEYSER M



PLAYPHASE GEYSER H

PLAYPHASE™



PUDDLES!

PUDDLE 1

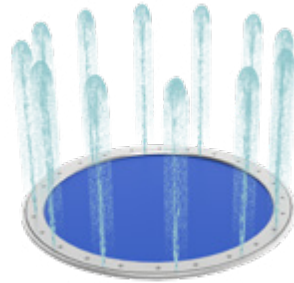

PUDDLE 2

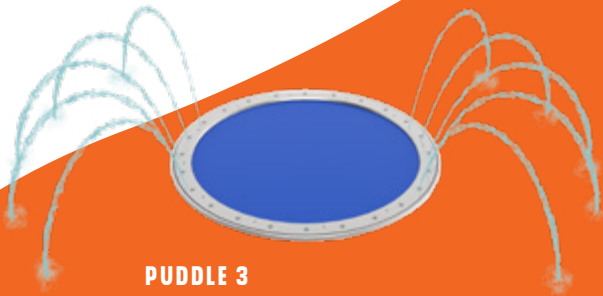

PUDDLE 3

JUMP SPLASH DISCOVER

An exciting take on the traditional ground spray, Puddles bring the fun of rain puddles to the play pad. Designed with a squishy jump pad, this ground spray encourages waterplayers to stomp, dance or hop to create a splashy water effect.

STONES

GROUND SPRAYS & PLAYABLE FOUNTAINS

Delight the senses with Stones! Inspired by the smooth pebbles of a shoreline, these giant stones provide a calm space for kids to rest, relax and explore gentle water effects. Stones are available in both dry and spraying options and feature a sand-blasted surface for safe play.





SURF STONE 1

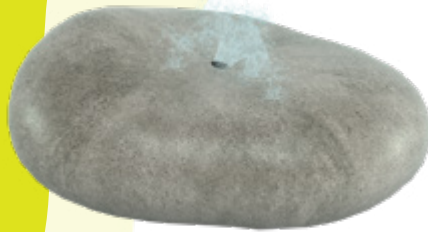

SURF STONE 2

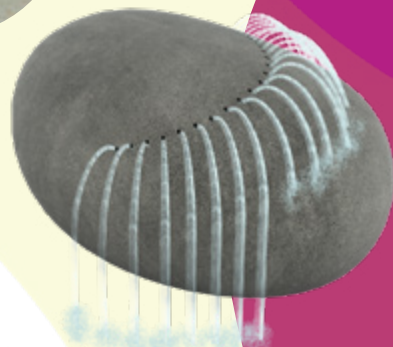

SAND STONE 1



SAND STONE 2



SURF STONE 3



LUMINARIES & GLOW EFFECTS

GROUND SPRAYS & PLAYABLE FOUNTAINS

Extend the hours of usage and create a striking water display that flows from day to night! Luminaries create a multi-functional space that glimmers between play and visual art.



MILLENNIA STYLUS PARK
CALIFORNIA, USA





LUMINARIES

Recessed LED lights illuminate integrated ground sprays.

GLOW EFFECTS

Flush-mounted LED lights illuminate the surrounding water.

AQUATIC FACILITY FEATURES

A place for everyone to enjoy. From a refreshing massage to an adventurous float down a crazy-lazy river, these unique features will add extra value to any aquatic facility.





NOT-SO LAZY RIVERS

AQUATIC FACILITY FEATURES

DIAL UP THE THRILL-O-METER!

From lazy to lively, these aquatic features transform lazy rivers into an attraction like no other! Turn your traditional lazy river into an adventure for all!



Create an immersive environment with creative theming options!



MODULAR

Available in two different heights, you can arrange a unique configuration for any river dimension!

EASY INSTALLATION

One connection point per feature reduces installation requirements and cost. Easily refresh your river features with playPHASE™ and playCONNECT™ mounting systems.



RIVER SPLASHOVER

RIVER SPOUT

RIVER BLOSSOM

RIVER SPLASH

RIVER NOOK

RIVER SPRITZ

**FITS ALL LAZY
RIVER WIDTHS**

THERAPY SPRAYS

AQUATIC FACILITY FEATURES



These dynamics water features double as a water massager and play element. The restorative sprays release a cascading shower of tranquil water to calm the mind, body and soul!



**MODERN, ELEGANT DESIGN...
SOOTHE ACHING MUSCLES
AND RELIEVE STRESS!**



RESTORATIVE SPRAY 1



RESTORATIVE SPRAY 2

Encourage repeat visits to your aquatic facility with this versatile hydrotherapy solution.

ACTIVITY TOWERS

Activity Towers are multi-level water play structures that provide captivating visitor experiences for waterplayers of all ages. Perfect for any facility or environment, they adapt to your unique space and can be phased over time for enduring play value.





ENDLESS DESIGN CONFIGURATIONS

With hundreds of Signature Design packages and customization options available, it's easy to **discover** the perfect tower for your unique attraction!

CLEAR SIGHTLINES

Large translucent panels and strategic elevations promote safe, confident play.

MAXIMUM PLAY VALUE

Interactive, easy-to-reach play elements and exciting water effects both on and off the structure. Panel splashers, cannons and sprays at multiple levels create exciting adventures for waterplayers of all ages.

BUILT TO LAST

All stainless steel construction, strong decks and durable coatings.

INTERCHANGEABLE & MODULAR

Increase attendance and keep visitors coming back for more. Plan for future expansions, newly added features and bigger splash effects with the playCONNECT™ removable feature mounting system.

EXPAND YOUR ADVENTURE!

PLAN FOR TOMORROW WITH TODAY'S BUDGET

...USING OUR UNIVERSAL
REMOVABLE FEATURE
MOUNTING SYSTEMS!



PLAYCONNECT™

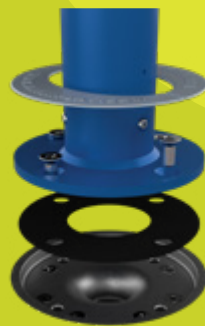

**CENTRE POST
PLAYPHASE™**

Activity Towers by Waterplay are ADA accessible and ASTM compliant.

SIGNATURE DESIGN SERIES

ACTIVITY TOWERS

MINIS

AGES 2+

FROM TODDLER TO EXPERIENCED

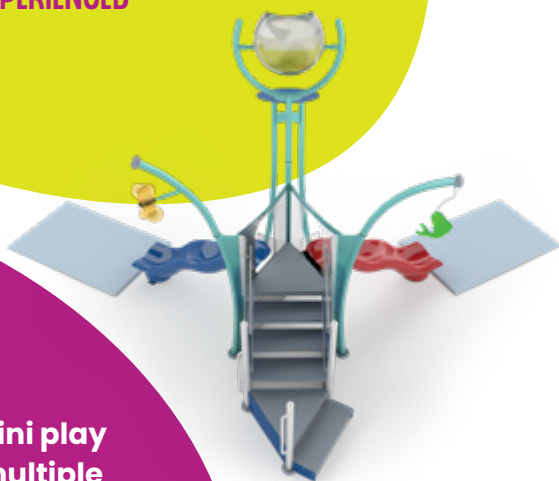

NAUTICAL N101

SLIDES 2

WATER FEATURES 3

LENGTH / WIDTH 27'5" x 23'2" (8.4m x 7.1m)

TOTAL HEIGHT 14'6" (4.44m)

APPLICATION Zero-depth / Pool / Slope

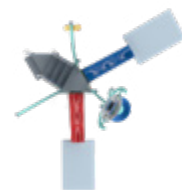

Neatly packed mini play structures with multiple spray encounters and design themes!

Perfect for tight spaces and smaller projects

Perimeter splashes and calm water effects

4' deck height & water slide

MINI BOAT

SLIDES 2

WATER FEATURES 11

LENGTH / WIDTH 35'10" x 24'9" (11.5m x 7.5m)

TOTAL HEIGHT 12'7" (3.8m)

APPLICATION Zero-depth / Pool / Slope

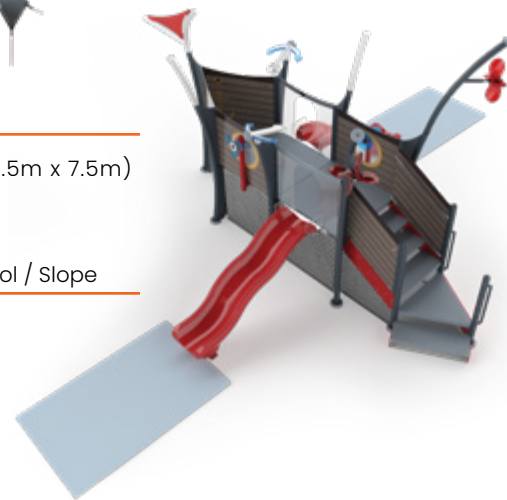

GRASSLANDS G100

SLIDES 1

WATER FEATURES 4

LENGTH / WIDTH 23'10" x 13'3" (7.26m x 4.04m)

TOTAL HEIGHT 14'5" (4.4m)

APPLICATION Zero-depth / Pool / Slope

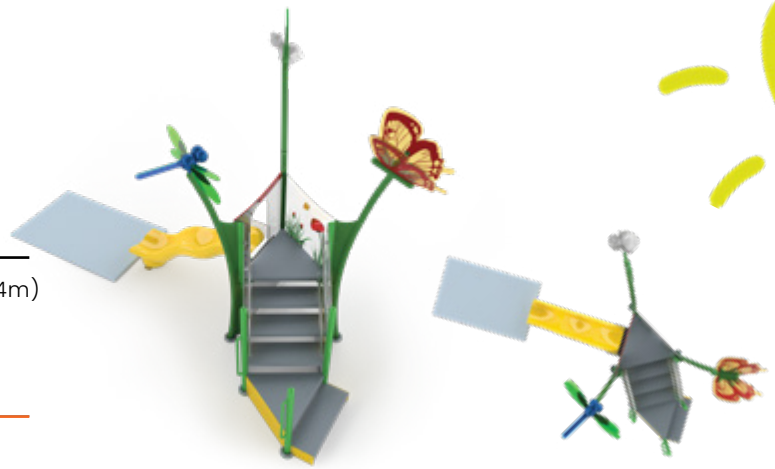

NAUTICAL N100

SLIDES 1

WATER FEATURES 4

LENGTH / WIDTH 24'x 14'3" (7.3m x 4.34m)

TOTAL HEIGHT 13'3" (4.04m)

APPLICATION Zero-depth / Pool / Slope

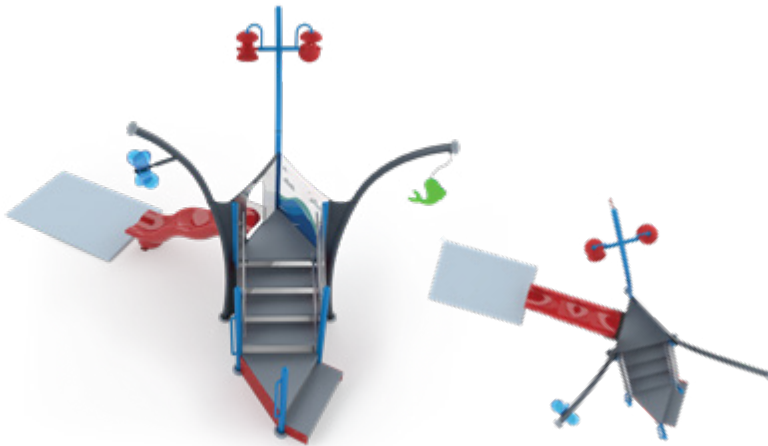

KALEIDOSCOPE K100

SLIDES 1

WATER FEATURES 4

LENGTH / WIDTH 22'6" x 13'8" (6.85m x 4.17m)

TOTAL HEIGHT 13'3" (4.04m)

APPLICATION Zero-depth / Pool / Slope

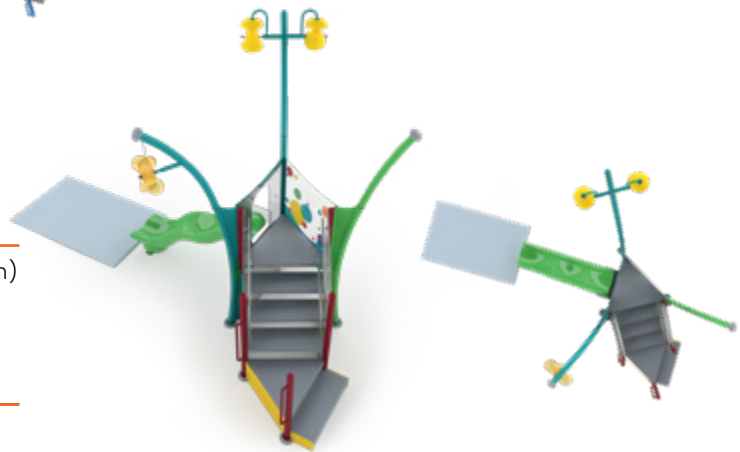

CIRQUE C100

SLIDES 1

WATER FEATURES 4

LENGTH / WIDTH 23'3" x 12'8" (7.07m x 3.85m)

TOTAL HEIGHT 12'5" (3.8m)

APPLICATION Zero-depth / Pool / Slope



SIGNATURE DESIGN SERIES

ACTIVITY TOWERS

DISCOVERY

AGES 2+

FROM TODDLER TO EXPERIENCED



GRASSLANDS G100

SLIDES	1
WATER FEATURES	10
LENGTH / WIDTH	35' x 18'9" (10.68m x 5.7m)
TOTAL HEIGHT	13' (3.96m)
ELEVATED AREA	47ft ² (4.4m ²)
APPLICATION	Zero-depth / Pool / Slope

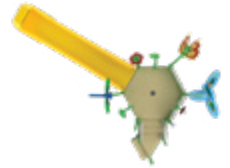

Compact towers bursting with interactive fun both on and off the structure!

1 activity pod & easy-to-reach play features

Perfect for tight spaces and smaller projects

Perimeter activities & interactive sprays

4' spacious deck height & water slides

NAUTICAL N101

SLIDES	1
WATER FEATURES	10
LENGTH / WIDTH	35" x 18'4" (10.68m x 5.6m)
TOTAL HEIGHT	13'9" (4.19m)
ELEVATED AREA	47ft ² (4.4m ²)
APPLICATION	Zero-depth / Pool / Slope

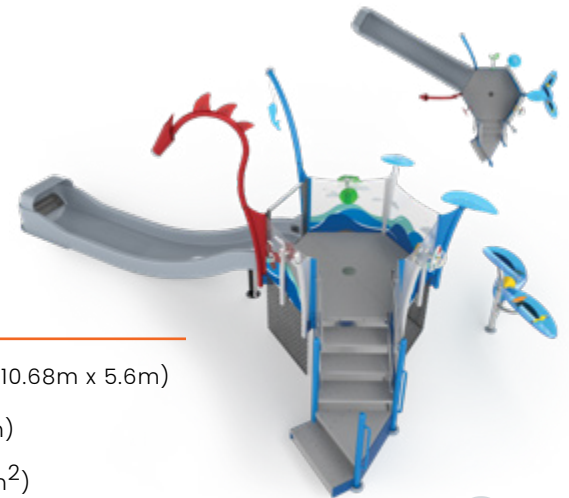

KALEIDOSCOPE K100

SLIDES 1
WATER FEATURES 10

LENGTH / WIDTH 35' x 18'4" (10.7m x 5.6m)

TOTAL HEIGHT 12'6" (3.8m)

ELEVATED AREA 47ft² (4.4m²)

APPLICATION Zero-depth / Pool / Slope

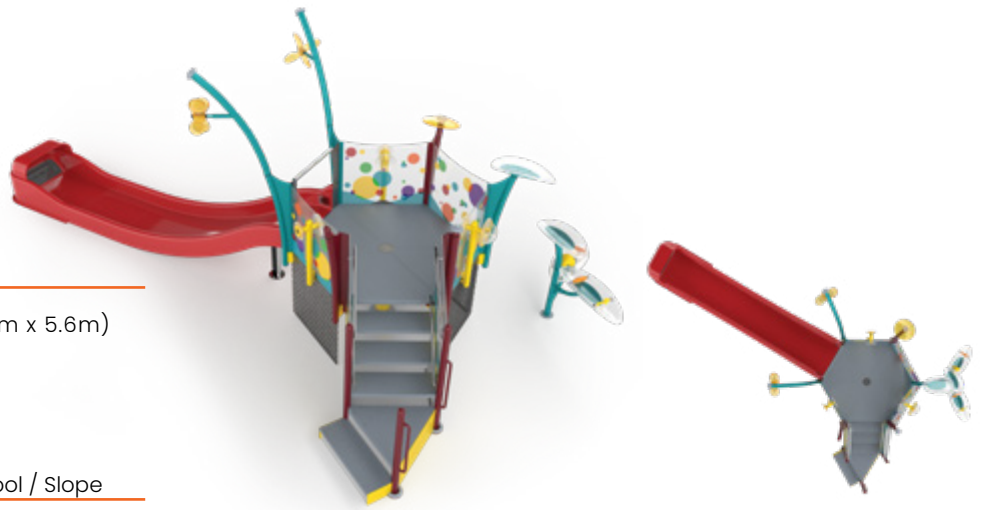

CIRQUE C100

SLIDES 1
WATER FEATURES 10

LENGTH / WIDTH 35' x 18'4" (10.68m x 5.6m)

TOTAL HEIGHT 12'5" (3.78m)

ELEVATED AREA 47ft² (4.4m²)

APPLICATION Zero-depth / Pool / Slope

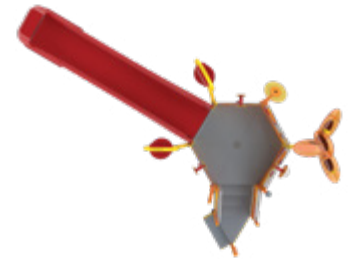

NAUTICAL N100

SLIDES 1
WATER FEATURES 10

LENGTH / WIDTH 32' x 16'5" (10m x 5m)

TOTAL HEIGHT 13'9" (4.2m)

ELEVATED AREA 47ft² (4.4m²)

APPLICATION Zero-depth / Pool / Slope

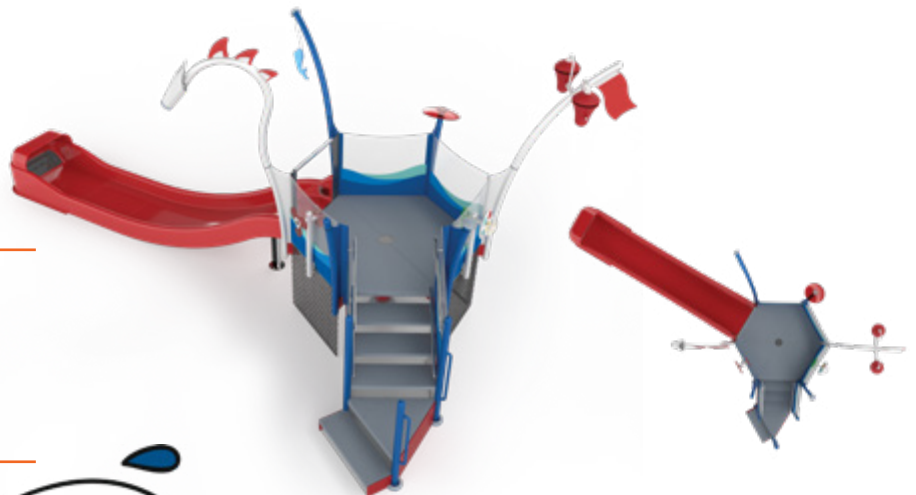

SIGNATURE DESIGN SERIES

ACTIVITY TOWERS

DISCOVERY

AGES 2+

FROM TODDLER TO EXPERIENCED

NAUTICAL N151

SLIDES 2

WATER FEATURES 12

LENGTH / WIDTH 32'2" x 33'5" (9.8m x 10.2m)

TOTAL HEIGHT 17'5" (5.3m)

ELEVATED AREA 90ft² (8.3m²)

APPLICATION Zero-depth / Pool / Slope



GRASSLANDS G150

SLIDES 2

WATER FEATURES 13

LENGTH / WIDTH 35'5" x 33'5" (10.8m x 10.2m)

TOTAL HEIGHT 14'8" (4.5m)

ELEVATED AREA 90ft² (8.3m²)

APPLICATION Zero-depth / Pool / Slope



NAUTICAL N150

SLIDES 2

WATER FEATURES 13

LENGTH / WIDTH 35'5" x 33'5" (10.8m x 10.2m)

TOTAL HEIGHT 14'8" (4.5m)

ELEVATED AREA 90ft² (8.3m²)

APPLICATION Zero-depth / Pool / Slope

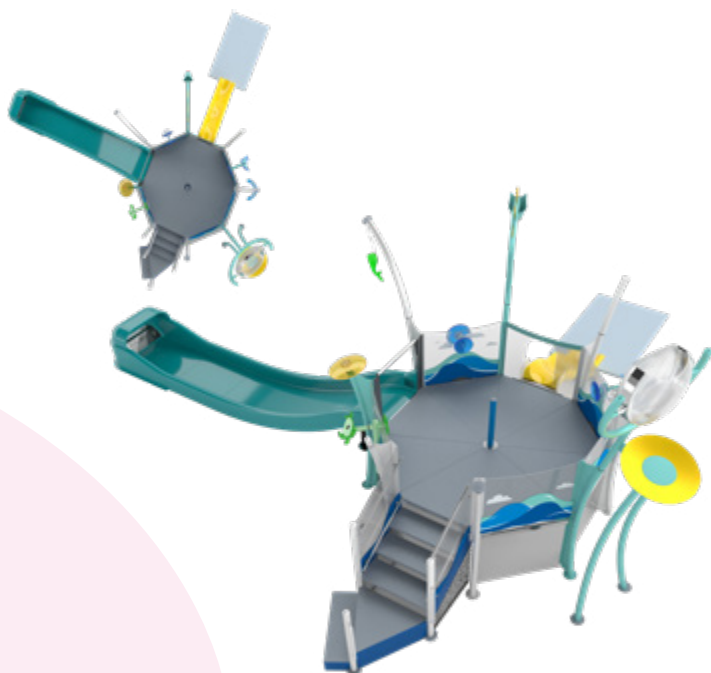

CIRQUE C150

SLIDES 2

WATER FEATURES 13

LENGTH / WIDTH 35'5" x 33'5" (10.8m x 10.2m)

TOTAL HEIGHT 14'8" (4.5m)

ELEVATED AREA 90ft² (8.3m²)

APPLICATION Zero-depth / Pool / Slope

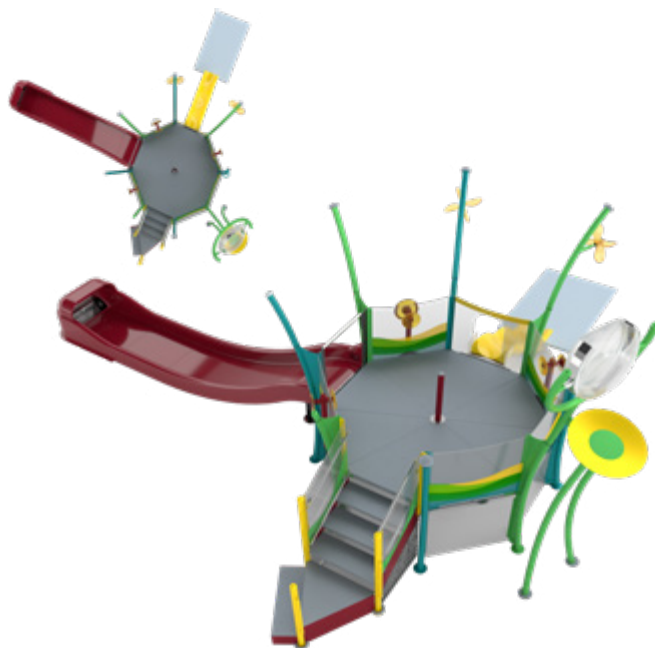

KALEIDOSCOPE K150

SLIDES 2

WATER FEATURES 13

LENGTH / WIDTH 35'5" x 33'5" (10.8m x 10.2m)

TOTAL HEIGHT 14'8" (4.5m)

ELEVATED AREA 90ft² (8.3m²)

APPLICATION Zero-depth / Pool / Slope

SIGNATURE DESIGN SERIES

ACTIVITY TOWERS

EXPLORATION

AGES 2+

FROM TODDLER TO EXPERIENCED

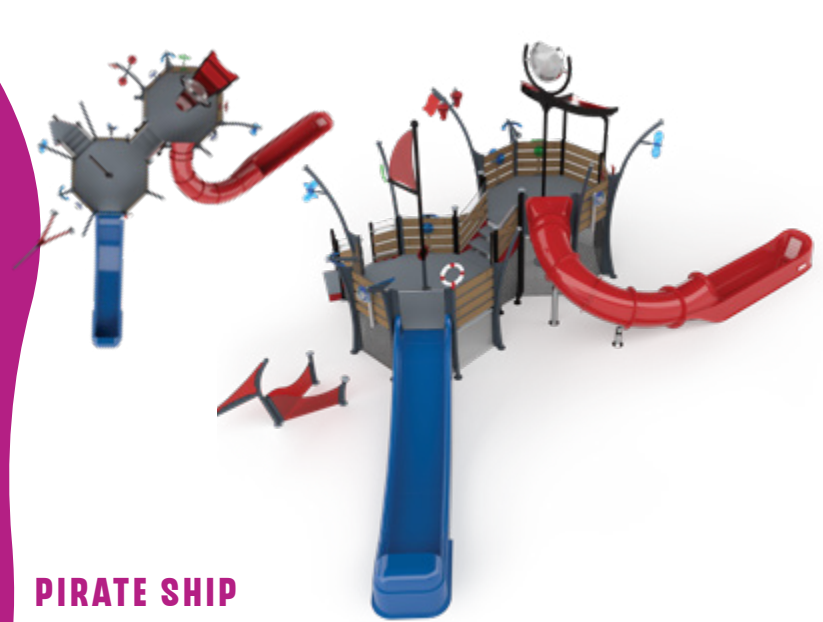

PIRATE SHIP

SLIDES 2

WATER FEATURES 28

LENGTH / WIDTH 50'10" x 31'11" (15.5m x 9.72m)

TOTAL HEIGHT 19'5" (5.9m)

ELEVATED AREA 137ft² (12.7m²)

APPLICATION Zero-depth / Pool / Slope

Build up the fun with a second pod and elevation gain and a towering splash!

2 activity pods & easy-to-reach play features

Introduces an elevation change
Perimeter activities & interactive sprays

4' and 6' spacious deck heights & exciting water slides

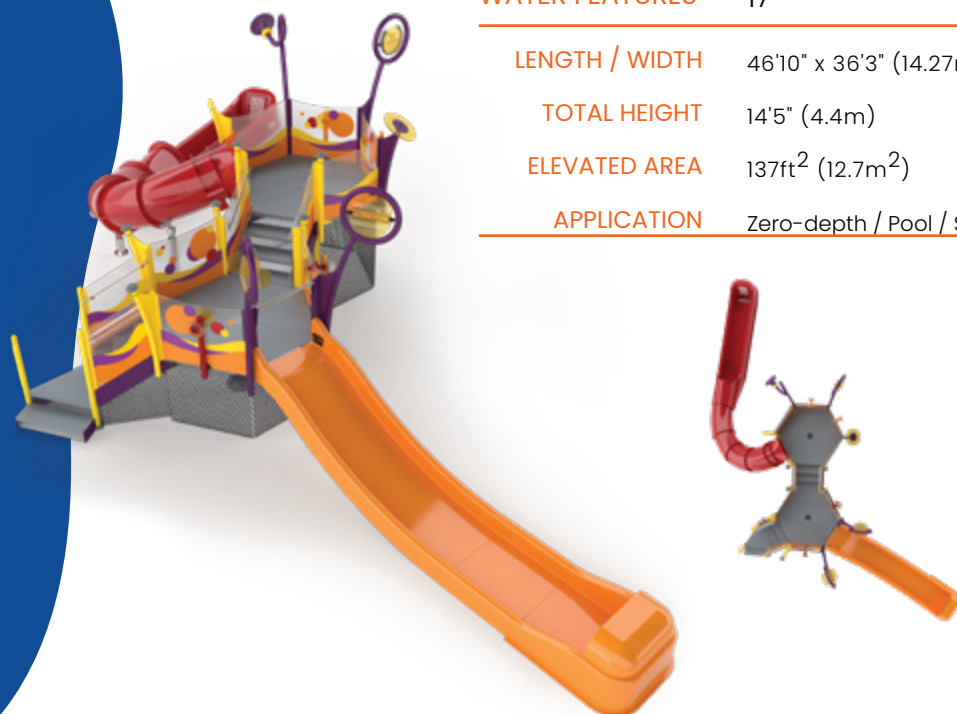

CIRQUE C200

SLIDES 2

WATER FEATURES 17

LENGTH / WIDTH 46'10" x 36'3" (14.27m x 11.1m)

TOTAL HEIGHT 14'5" (4.4m)

ELEVATED AREA 137ft² (12.7m²)

APPLICATION Zero-depth / Pool / Slope



KALEIDOSCOPE K200

SLIDES 2

WATER FEATURES 17

LENGTH / WIDTH 46'10" x 36'4" (14.27m x 11.07m)

TOTAL HEIGHT 15'3" (4.7m)

ELEVATED AREA 137ft² (12.7m²)

APPLICATION Zero-depth / Pool / Slope



NAUTICAL N200

SLIDES 2

WATER FEATURES 17

LENGTH / WIDTH 46'10" x 36'3" (14.27m x 11.05m)

TOTAL HEIGHT 14'8" (4.5m)

ELEVATED AREA 137ft² (12.7m²)

APPLICATION Zero-depth / Pool / Slope

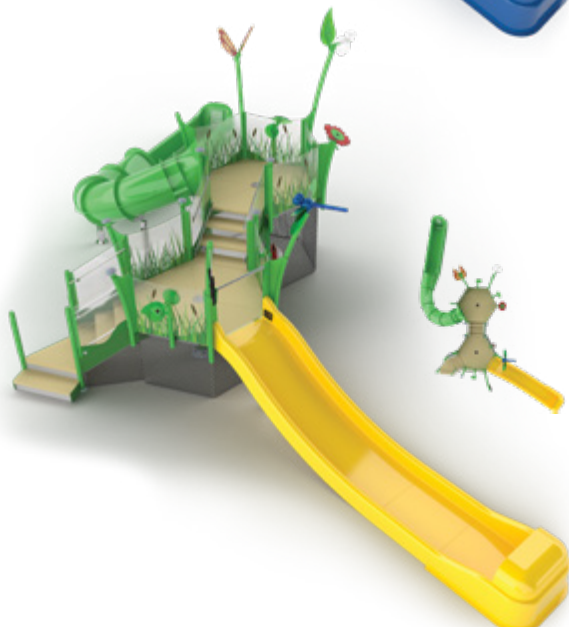

GRASSLANDS G200

SLIDES 2

WATER FEATURES 17

LENGTH / WIDTH 46'10" x 36'3" (14.27m x 11.05m)

TOTAL HEIGHT 16'6" (5.02m)

ELEVATED AREA 137ft² (12.7m²)

APPLICATION Zero-depth / Pool / Slope



SIGNATURE DESIGN SERIES

ACTIVITY TOWERS

EXPLORATION

AGES 2+

FROM TODDLER TO EXPERIENCED



KALEIDOSCOPE K250

SLIDES 2

WATER FEATURES 17

LENGTH / WIDTH 46'10" x 39'9" (14.3m x 12.1m)

TOTAL HEIGHT 17'5" (5.3m)

ELEVATED AREA 137ft² (12.7m²)

APPLICATION Zero-depth / Pool / Slope

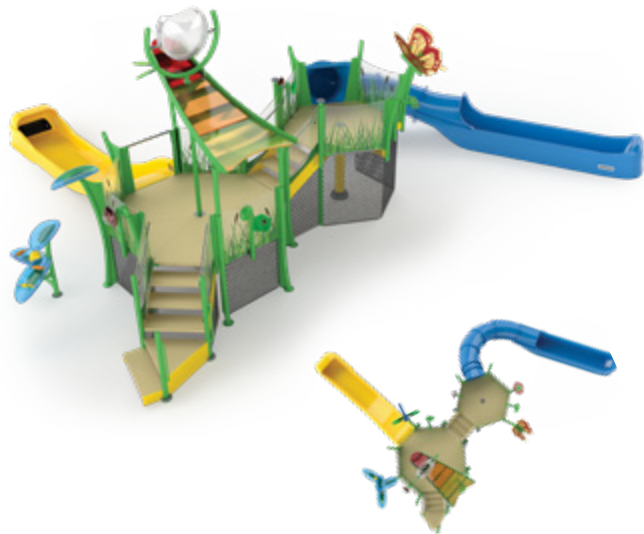

GRASSLANDS G250

SLIDES 2

WATER FEATURES 17

LENGTH / WIDTH 46'10" x 39'9" (14.3m x 12.1m)

TOTAL HEIGHT 17'5" (5.3m)

ELEVATED AREA 137ft² (12.7m²)

APPLICATION Zero-depth / Pool / Slope

CIRQUE C250

SLIDES 2

WATER FEATURES 17

LENGTH / WIDTH 46'10" x 39'9" (14.3m x 12.1m)

TOTAL HEIGHT 17'5" (5.3m)

ELEVATED AREA 137ft² (12.7m²)

APPLICATION Zero-depth / Pool / Slope



NAUTICAL N250

SLIDES 2

WATER FEATURES 17

LENGTH / WIDTH 46'10" x 39'9" (14.3m x 12.1m)

TOTAL HEIGHT 17'5" (5.3m)

ELEVATED AREA 137ft² (12.7m²)

APPLICATION Zero-depth / Pool / Slope



SIGNATURE DESIGN SERIES

ACTIVITY TOWERS

ADVENTURE

AGES 4+

Give them an unforgettable adventure packed with sky-high thrills, big splashes and unmatched play value.

Perfect for larger projects and attractions

Multiple pods & elevation changes!

Perimeter splashes & interactive sprays

Open and closed water slides

4', 6' and 8' spacious deck heights



SPACIOUS DECKS



HEX POD
47FT² (4.4M²)



OCTO POD
90FT² (8.3M²)

TORTUGA ADVENTURE

SLIDES 3

WATER FEATURES 43

LENGTH / WIDTH 54'2" x 51'2" (16.5m x 15.6m)

TOTAL HEIGHT 19'5" (5.9m)

ELEVATED AREA 274ft² (25.5m²)

APPLICATION Zero-depth / Pool / Slope



NAUTICAL N300

SLIDES 3

WATER FEATURES 23

LENGTH / WIDTH 56'3" x 44'11" (17.1m x 13.7m)

TOTAL HEIGHT 19'5" (5.9m)

ELEVATED AREA 184ft² (17.1m²)

APPLICATION Zero-depth / Pool / Slope



CIRQUE C300

SLIDES 3

WATER FEATURES 23

LENGTH / WIDTH 56'3" x 44'11" (17.1m x 13.7m)

TOTAL HEIGHT 19'5" (5.9m)

ELEVATED AREA 184ft² (17.1m²)

APPLICATION Zero-depth / Pool / Slope



KALEIDOSCOPE K300

SLIDES 3

WATER FEATURES 23

LENGTH / WIDTH 56'3" x 44'11" (17.1m x 13.7m)

TOTAL HEIGHT 19'5" (5.9m)

ELEVATED AREA 184ft² (17.1m²)

APPLICATION Zero-depth / Pool / Slope



GRASSLANDS G300

SLIDES 3

WATER FEATURES 23

LENGTH / WIDTH 56'3" x 44'11" (17.1m x 13.7m)

TOTAL HEIGHT 19'5" (5.9m)

ELEVATED AREA 184ft² (17.1m²)

APPLICATION Zero-depth / Pool / Slope



“OUR GUESTS LOVE THE NEW FEATURES AND WE ARE EXCITED TO HAVE UPDATED OUR POOL WITH SUCH A FUN, CREATIVE STRUCTURE.”

LAURI DANNEMILLER
Executive Director
Apex Parks & Recreation District
USA





A stunning facility renovation—the **Apex Recreation Center** in Arvada, Colorado transformed its outdated leisure pool into a multi-level Activity Tower attraction. A **Grasslands** design narrated by lively wildflowers, splashing insects and Tower Soaker re-invigorates the play experience for all ages and energy levels.





WATER MANAGEMENT SOLUTIONS

Water management is about making the water work for the specific needs of your aquatic play design and the surrounding infrastructure.

With options for every project, Waterplay's tools and systems lead the industry in technology and function. Work with Waterplay to find the best solution for your space.



TOOLS

WATER MANAGEMENT SOLUTIONS

CREATE SUSTAINABLE PLAY SPACES

Knowing what happens with the water is a big part of your project. Work with Waterplay to find the best solution for your space.

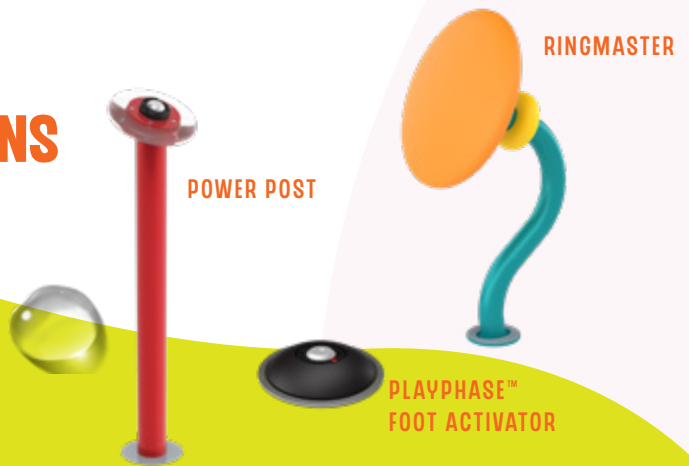
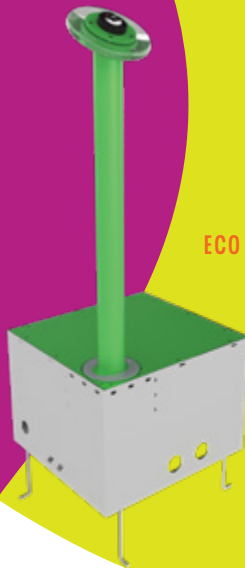

ACTIVATORS

Optimize water use and maximize play value through action-reaction play outcomes and sequencing with Waterplay's on demand activators.

ECO ACTIVATOR

The Eco Activator

is an all-in-one water management solution for small aquatic spaces, it combines manifold and controller technology in one flush-to-grade solution.

*Supports up to 40 GPM (151 LPM)
For more information, please refer to the Water Management brochure

DRAINS



CLASSIC DRAIN

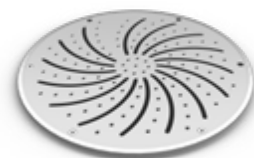

STAINLESS STEEL DRAIN

AVAILABLE COLOURS:
standard waterplay colours

CONTROLLERS

Waterplay® smartACCESS™

Control multiple play spaces from one screen through the intuitive user interface and collect data for analyzing and reporting. Waterplay's smartACCESS connects you to what's happening at your play space anywhere, anytime.

**BASIC
CONTROLLER**



SMARTPLAY™ CONTROLLER

MANIFOLDS

Available in 6, 9, 12, 15 and 18 valve configurations to adapt to any project size.



KIOSKS & VAULTS

ABOVE GRADE KIOSK

Available in 6, 10, and 18 valve configurations to adapt to any project size.

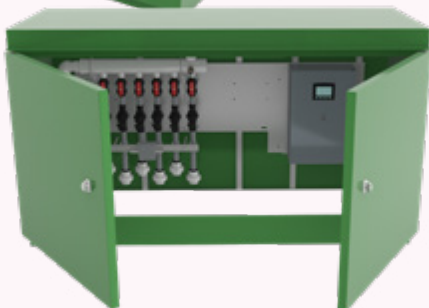

BELOW GRADE VAULT

Available in 6, 10, and 18 valve configurations to adapt to any project size.



* TANKS AVAILABLE UPON REQUEST

NOTE: Equipment may vary based on the requirements of the design.

RECIRCULATION

Waterplay's recirculation system functions as a closed water management unit that continually recycles treated water to and from the play space.



WATER MANAGEMENT SYSTEMS

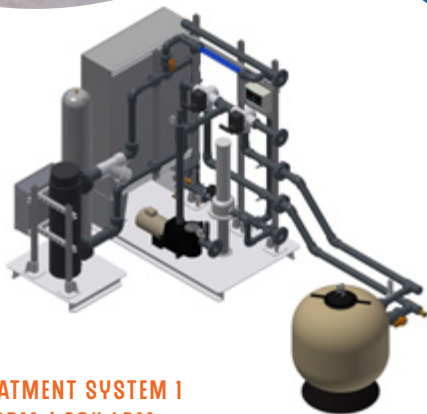

TREATMENT SYSTEM 1
75 GPM / 284 LPM

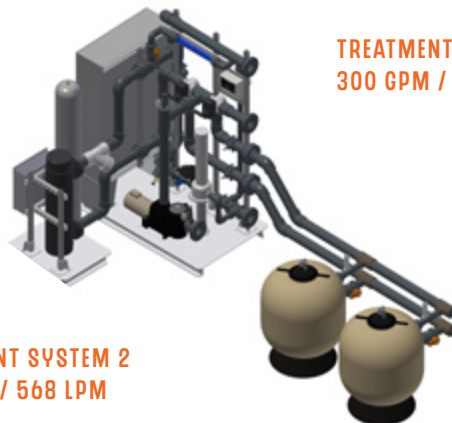

TREATMENT SYSTEM 2
150 GPM / 568 LPM

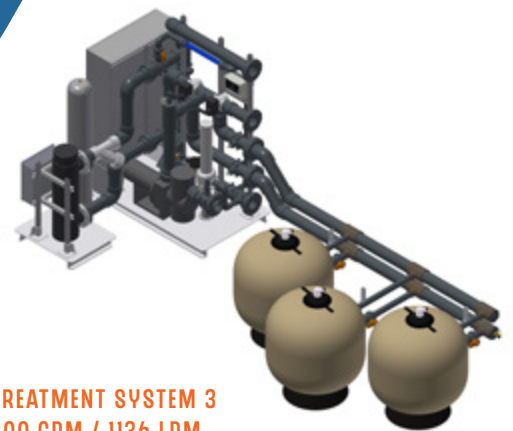

TREATMENT SYSTEM 3
300 GPM / 1136 LPM

2

CONTROLLER & MANIFOLD

The smartPLAY™ Controller & manifold work together to route the water to the play space based on programmed sequences.

1

ACTIVATOR

Use the activator to trigger the controller.

3

DRAIN

The drain leads the water away from the play space and filters debris.



**UV
TREATMENT
AVAILABLE**



2

6

3

4

5

4

DIVERTER & STRAINER

The diverter & strainer captures debris and redirects rainwater to reduce overall chemical consumption.

5

HOLDING TANK

The holding tank contains water on the way to the water management system where the primary chemical disinfection occurs.

6

WATER MANAGEMENT SYSTEM

The recirculation system maintains water quality using advanced water treatment technologies. Water is continuously recycled to and from the play space using this method.

FLOW THROUGH

Waterplay's flow through water management system drains into the local sanitary or storm drain system. The water is then handled according to local municipal water management strategies.

1

ACTIVATOR

Use the activator to trigger the controller.

2

CONTROLLER & MANIFOLD

The smartPLAY™ Controller & manifold work together to route the water to the play space based on programmed sequences.

3

DRAIN

The drain leads the water away from the play space and filters debris.



PERCOLATION

Consider a percolation system: water percolates from a below ground containment system and returns to the water table as a part of the natural hydrological cycle.

1

3

4

WATER MANAGEMENT SYSTEM

In a flow through system the water is introduced into the local municipal infrastructure via sanitary or storm drain systems.

2

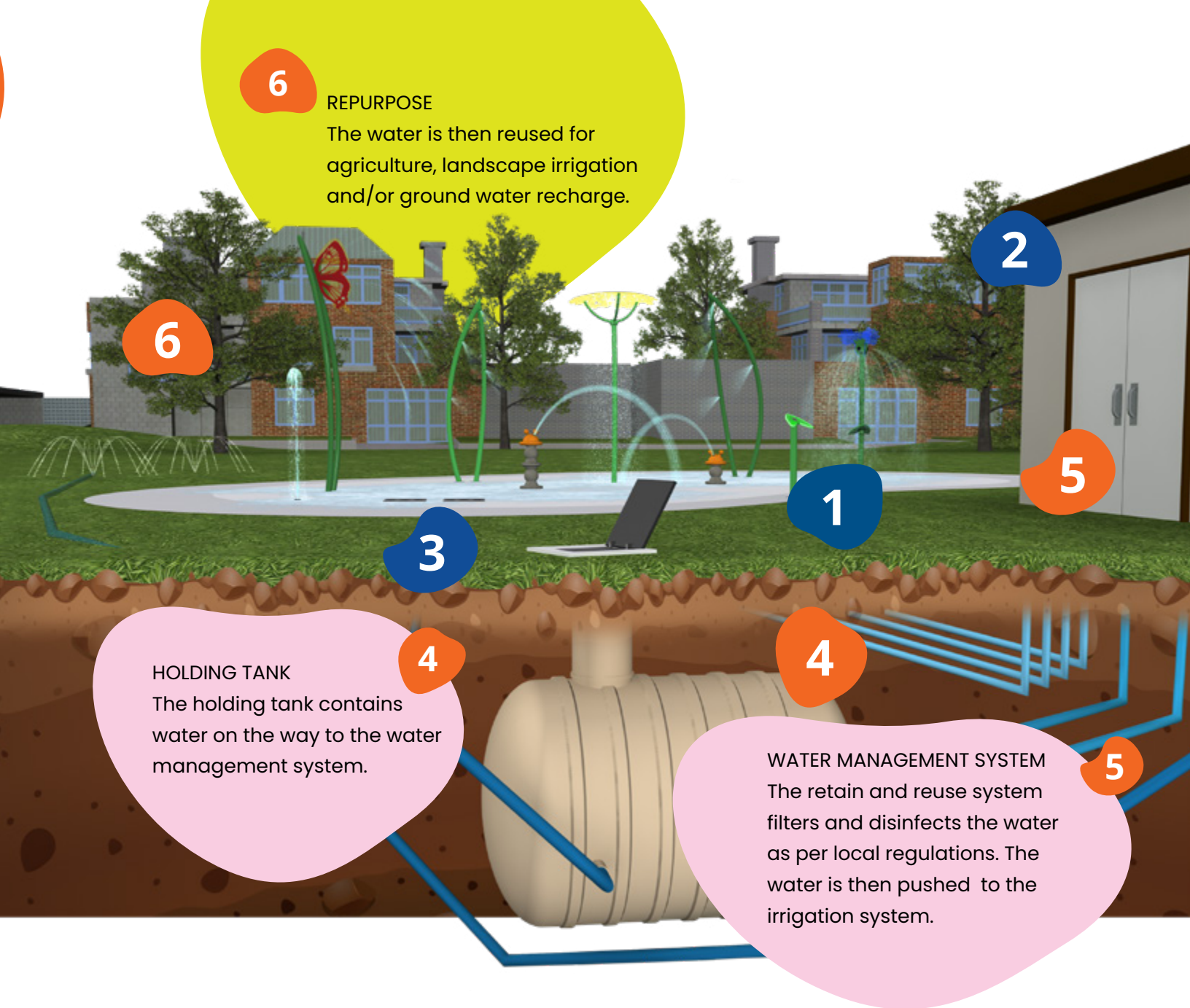

6

REPURPOSE

The water is then reused for agriculture, landscape irrigation and/or ground water recharge.

6

2

5

1

3

HOLDING TANK

The holding tank contains water on the way to the water management system.

4

4

WATER MANAGEMENT SYSTEM

The retain and reuse system filters and disinfects the water as per local regulations. The water is then pushed to the irrigation system.

5

RETAIN & REUSE

Retain & reuse water management systems capture and repurpose water from the play pad for alternative uses in the community.

TECHNOLOGIES & MATERIALS

At Waterplay, we **CARE** about quality. Our industry-leading materials are carefully selected to ensure safe play experiences that stand the test of time. Our products are made of stainless steel and use some of the most enduring materials in the industry.

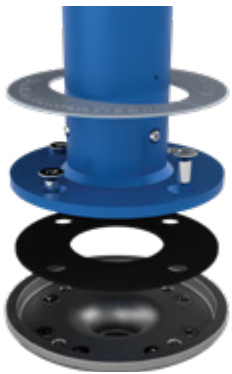

playPHASE™

Phase your project, expand your play space and easily retrofit with playPHASE™, a flush-to-grade anchoring system that eliminates the need for toe guards and allows you to start construction early while we finish manufacturing your features.



playCONNECT™

The industry's first modular feature mounting system for activity towers simplifies the installation and reduces the need for cranes. Phase, expand, add, remove or replace features with playCONNECT™ to extend the lifetime of your structure.



ON DEMAND WATER ACTIVATION

Optimize water use and maximize play value with Waterplay's on demand button activators. A perfect solution for reducing water consumption while creating a dynamic play experience. **Push** to start the flow of water.

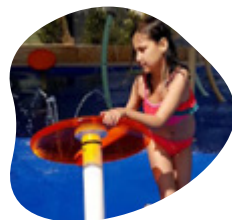

ACTION ACTIVATORS™

Bring surrounding play features to life by **spinning** the Ringmaster or **twisting** the Whirler. Waterplay's unique Action Activators™ are the perfect blend of play value and water conservation.



360° ROTATIONAL HUB

Easy movement for all ages and abilities, the 360° rotational hub features continuous and smooth movement for maximum play value.



AQUALUME™

Make a statement in your next design with Waterplay's AquaLume™, an impact resistant and durable polymer that blends colour with water and light for a truly stunning play experience.

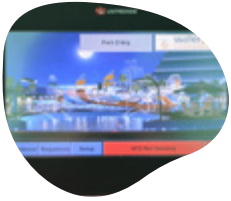

smartPLAY™ CONTROLLER

The controller tells the water what it should do and when to do it. Waterplay's smartPLAY™ Controller works in conjunction with the manifold and water activator to create the perfect play experience for your project.



smartACCESS™

Waterplay's smartACCESS connects you to what's happening at your play space anywhere, anytime. Manage water for multiple play spaces from one screen through the intuitive user interface and collect data for analyzing and reporting.



CAUSE & EFFECT NOZZLES

Stimulate curiosity and team play in your play space. Interactive ground sprays erupt with a bigger and bigger spray as waterplayers work together to plug and cover the nozzles.

SCHEDULE 10 & 40, 304 STAINLESS STEEL PIPE (316 AVAILABLE) | best performance in all environments
MIG & TIG WELDS | superior weld strength and finish
SUPER DURABLE POWDER COATING | superior chip and fade resistant.
TOUGH FINISHES | defense against extreme climates, temperatures, moisture and UV exposure.
STAINLESS STEEL HARDWARE | durable and resistant
ACETAL NOZZLES | durable material that eliminates corrosion
WARRANTY | industry leading for structural integrity of stainless steel piping and weldments

LET'S CREATE SOMETHING AWESOME!

WATERPLAY HAS LOCAL OFFICES POSITIONED THROUGHOUT NORTH AMERICA ALONGSIDE A TEAM OF EXPERT DEALERS AROUND THE GLOBE.

WE GOT YOU!

waterplay.com



MAKR GROUP + WATERPLAY

805 Crowley Avenue
Kelowna, BC V1Y 7G6 Canada



NORTH AMERICA

1.888.890.MAKR



GENERAL INQUIRIES

info@waterplay.com

INTERNATIONAL

+1.250 712.3393

AFRICA | ASIA | AUSTRALIA | EUROPE | NORTH AMERICA | SOUTH AMERICA

Due to our commitment to continuous improvement and innovation, Waterplay Solutions Corp.® reserves the right to change product specifications without notice. Where dimensions or performance criteria are critical, please contact us for the latest product information. Photos displayed may not be representative of current design. The products, designs and photographs contained in this catalogue are protected by international copyright and other laws 2023. Waterplay is a registered trademark of MAKR Play Group inc. and is used under license. Copyright © 2023 Waterplay® Solutions Corp. All Rights Reserved.





WE'RE A TINY PIECE OF A BIGGER PUZZLE, BUT AN IMPORTANT PIECE.

We're a group of MAKRs and our purpose,
our common goal, our passion, is to connect
communities through play and social experiences.
We do this through the group of companies that
"makr" up the MAKR Group:

PARKWORKS + WATERPLAY + WEKID MFG



General Inquiries

info@waterplay.com



Waterplay + MAKR Group

805 Crowley Avenue
Kelowna, B.C. V1Y 7G6 Canada



North America

1.888.890.MAKR (6257)

International

+1.250.712.3393



FIND US:
waterplay.com

ISO
9001:2015
QUALITY
MGMT SYSTEM
CERTIFIED

ISO
14001:2015
ENVIRONMENTAL
MGMT SYSTEM
CERTIFIED

**WOMEN
OWNED™**